



**FA**  
**06**      **FA**  
**07**      **FA**  
**08**

Parameter Guide

Roland

# Contents

<b>Studio Set</b> .....	<b>5</b>	TREMOLO/PAN .....	<b>21</b>
STUDIO SET COMMON .....	<b>5</b>	OVERDRIVE .....	<b>21</b>
General tab .....	<b>5</b>	DISTORTION .....	<b>21</b>
Control tab .....	<b>5</b>	FUZZ .....	<b>21</b>
Phase Lock tab .....	<b>5</b>	OCTAVE .....	<b>22</b>
Pedal tab .....	<b>6</b>	SUBSONIC .....	<b>22</b>
S1/S2 tab .....	<b>6</b>	RING MOD. ....	<b>22</b>
Knob tab .....	<b>6</b>	CHROMATIC PS .....	<b>22</b>
D-Beam tab .....	<b>7</b>	C. CANCELLER .....	<b>22</b>
Control Sw tab .....	<b>8</b>	VINYL SIM .....	<b>22</b>
PART VIEW .....	<b>9</b>	RADIO TUNING .....	<b>22</b>
Level/Pan tab .....	<b>9</b>	NOISE GEN .....	<b>22</b>
Keyboard tab .....	<b>9</b>	COMP .....	<b>22</b>
Output/EFX tab .....	<b>10</b>	EQUALIZER .....	<b>22</b>
EQ tab .....	<b>10</b>		
Pitch tab .....	<b>11</b>	<b>SuperNATURAL Acoustic Tone (SN-A)</b> .....	<b>24</b>
Scale Tune tab .....	<b>11</b>	TONE EDIT (SN-A) .....	<b>24</b>
Vibrato tab .....	<b>12</b>	Common tab .....	<b>24</b>
Offset tab .....	<b>12</b>	Inst tab .....	<b>25</b>
Mono/Poly/Legato tab .....	<b>13</b>	Instrument List .....	<b>25</b>
Voice Reserve tab .....	<b>13</b>	SuperNATURAL Inst Parameters .....	<b>26</b>
MIDI Rx Filter tab .....	<b>13</b>	Performance Variation Sounds .....	<b>29</b>
		MFX tab .....	<b>30</b>
		MFX Control tab .....	<b>30</b>
<b>EFFECTS EDIT</b> .....	<b>14</b>		
STUDIO SET EFFECTS .....	<b>15</b>	<b>SuperNATURAL Synth Tone (SN-S)</b> .....	<b>31</b>
Chorus tab .....	<b>15</b>	TONE EDIT (SN-S) .....	<b>31</b>
Reverb tab .....	<b>15</b>	Common tab .....	<b>31</b>
Comp+EQ Output tab .....	<b>16</b>	OSC tab .....	<b>33</b>
Master Comp tab .....	<b>16</b>	Pitch tab .....	<b>33</b>
IFX tab .....	<b>16</b>	Filter tab .....	<b>34</b>
TONE EFFECTS (MFX, COMP+EQ) .....	<b>17</b>	Amp tab .....	<b>35</b>
SYSTEM EFFECTS .....	<b>18</b>	LFO tab .....	<b>35</b>
Audio Input tab .....	<b>18</b>	Modulation LFO tab .....	<b>36</b>
USB Audio tab .....	<b>18</b>	Aftertouch tab .....	<b>36</b>
Noise Suppressor tab .....	<b>18</b>	Misc tab .....	<b>36</b>
MIC Reverb tab .....	<b>18</b>	MFX tab .....	<b>37</b>
Master EQ tab .....	<b>19</b>	MFX Control tab .....	<b>37</b>
TFX tab .....	<b>19</b>		
TFX Parameters .....	<b>20</b>	<b>SuperNATURAL Drum Kit (SN-D)</b> .....	<b>38</b>
FILTER+DRIVE .....	<b>20</b>	TONE EDIT (SN-D) .....	<b>38</b>
ISOLATOR .....	<b>20</b>	Common tab .....	<b>38</b>
DJFX LOOPER .....	<b>20</b>	DRUM Inst tab .....	<b>38</b>
BPM LOOPER .....	<b>20</b>	Comp tab .....	<b>39</b>
BIT CRUSH .....	<b>20</b>	EQ tab .....	<b>39</b>
WAH .....	<b>20</b>	MFX tab .....	<b>39</b>
REVERB .....	<b>20</b>	MFX Control tab .....	<b>39</b>
DELAY .....	<b>20</b>	SuperNATURAL Drum Inst List .....	<b>40</b>
TAPE ECHO .....	<b>20</b>		
PITCH SHIFTER .....	<b>21</b>	<b>PCM Synth Tone (PCMS)</b> .....	<b>42</b>
VOICE TRANS .....	<b>21</b>	TONE EDIT (PCMS) .....	<b>42</b>
FLANGER .....	<b>21</b>	Common tab .....	<b>42</b>
SLICER+FLG .....	<b>21</b>	Wave tab .....	<b>45</b>
PHASER .....	<b>21</b>	PMT tab .....	<b>47</b>
CHORUS .....	<b>21</b>	Pitch tab .....	<b>49</b>

Pitch Env tab .....	50	Slicer .....	75
TVF tab .....	51	Rotary .....	75
TVF Env tab .....	52	VK Rotary .....	76
TVA tab .....	53	Chorus .....	76
TVA Env tab .....	54	Flanger .....	76
Output tab .....	55	Step Flanger .....	77
LFO1/LFO2 tab .....	55	Hexa-Chorus .....	77
Step LFO tab .....	57	Tremolo Chorus .....	77
How to Apply the LFO .....	57	Space-D .....	77
Control tab .....	58	3D Chorus .....	78
Matrix Control 1–4 tab .....	58	3D Flanger .....	78
MFX tab .....	60	3D Step Flanger .....	78
MFX Control tab .....	60	2 Band Chorus .....	79
<b>PCM Drum Kit (PCMD) .....</b>	<b>61</b>	2 Band Flanger .....	79
TONE EDIT (PCMD) .....	61	2 Band Step Flanger .....	79
Common tab .....	61	Overdrive .....	80
Wave tab .....	62	Distortion .....	80
WMT tab .....	63	VS Overdrive .....	80
Pitch tab .....	63	VS Distortion .....	80
Pitch Env tab .....	63	Guitar Amp Simulator .....	80
TVF tab .....	64	Compressor .....	81
TVF Env tab .....	65	Limiter .....	81
TVA tab .....	65	Gate .....	81
TVA Env tab .....	66	Delay .....	81
Output tab .....	66	Long Delay .....	82
Comp tab .....	66	Serial Delay .....	82
EQ tab .....	67	Modulation Delay .....	82
MFX tab .....	67	3Tap Pan Delay .....	83
MFX Control tab .....	67	4Tap Pan Delay .....	83
<b>Chorus, Reverb .....</b>	<b>68</b>	Multi Tap Delay .....	83
Chorus Parameters .....	68	Reverse Delay .....	84
Reverb Parameters .....	68	Shuffle Delay .....	84
<b>IFX Parameters .....</b>	<b>69</b>	3D Delay .....	84
Equalizer .....	70	Time Ctrl Delay .....	85
Spectrum .....	70	Long Time Ctrl Delay .....	85
Isolator .....	70	Tape Echo .....	85
Low Boost .....	70	Lofi Noise .....	86
Super Filter .....	71	Lofi Compress .....	86
Step Filter .....	71	Lofi Radio .....	86
Enhancer .....	71	Telephone .....	87
Auto Wah .....	72	Phonograph .....	87
Humanizer .....	72	Pitch Shifter .....	87
Speaker Simulator .....	72	2Voice Pitch Shifter .....	87
Phaser .....	73	Step Pitch Shifter .....	88
Step Phaser .....	73	Reverb .....	88
Multi Stage Phaser .....	73	Gated Reverb .....	88
Infinite Phaser .....	73	Overdrive → Chorus .....	89
Ring Modulator .....	74	Overdrive → Flanger .....	89
Step Ring Modulator .....	74	Overdrive → Delay .....	89
Tremolo .....	74	Distortion → Chorus .....	89
Auto Pan .....	74	Distortion → Flanger .....	89
Step Pan .....	75	Distortion → Delay .....	90
		Enhancer → Chorus .....	90
		Enhancer → Flanger .....	90

# Contents

---

Enhancer → Delay .....	90	Overdrive → Delay .....	109
Chorus → Delay .....	90	Distortion → Chorus .....	109
Flanger → Delay .....	91	Distortion → Flanger .....	109
Chorus → Flanger .....	91	Distortion → Delay .....	109
Sympathetic Resonance .....	91	OD/DS → TouchWah .....	109
When Using 3D Effects .....	92	OD/DS → AutoWah .....	110
<hr/>			
<b>MFX Parameters .....</b>	<b>93</b>	GuitarAmpSim → Chorus .....	110
Equalizer .....	94	GuitarAmpSim → Flanger .....	111
Spectrum .....	94	GuitarAmpSim → Phaser .....	111
Low Boost .....	94	GuitarAmpSim → Delay .....	112
Step Filter .....	94	EP AmpSim → Tremolo .....	113
Enhancer .....	95	EP AmpSim → Chorus .....	113
Auto Wah .....	95	EP AmpSim → Flanger .....	113
Humanizer .....	95	EP AmpSim → Phaser .....	114
Speaker Simulator .....	95	EP AmpSim → Delay .....	114
Phaser 1 .....	96	Enhancer → Chorus .....	115
Phaser 2 .....	96	Enhancer → Flanger .....	115
Phaser 3 .....	96	Enhancer → Delay .....	115
Step Phaser .....	97	Chorus → Delay .....	115
Multi Stage Phaser .....	97	Flanger → Delay .....	116
Infinite Phaser .....	97	Chorus → Flanger .....	116
Ring Modulator .....	98	Vocoder .....	116
Tremolo .....	98	About the STEP RESET Function .....	117
Auto Pan .....	98	Controlling a MFX via MIDI (MFX CONTROL) .....	117
Slicer .....	98	<hr/>	
Rotary 1 .....	99	<b>SuperNATURAL Tone CC Assign .....</b>	<b>118</b>
Rotary 2 .....	99	SuperNATURAL Acoustic (SN-A) .....	118
Rotary 3 .....	100	SuperNATURAL Drum (SN-D) .....	120
Chorus .....	100		
Flanger .....	101		
Step Flanger .....	101		
Hexa-Chorus .....	102		
Tremolo Chorus .....	102		
Space-D .....	102		
Overdrive .....	102		
Distortion .....	102		
Guitar Amp Simulator .....	103		
Compressor .....	103		
Limiter .....	103		
Gate .....	104		
Delay .....	104		
Modulation Delay .....	105		
3Tap Pan Delay .....	105		
4Tap Pan Delay .....	105		
Multi Tap Delay .....	106		
Reverse Delay .....	106		
Time Ctrl Delay .....	107		
LOFI Compress .....	107		
Bit Crusher .....	107		
Pitch Shifter .....	107		
2Voice Pitch Shifter .....	108		
Overdrive → Chorus .....	108		
Overdrive → Flanger .....	108		

## STUDIO SET COMMON

1. Press the [MENU] button.
2. Move the cursor to “Studio Set Common” and press the [ENTER] button.

The STUDIO SET COMMON screen appears.

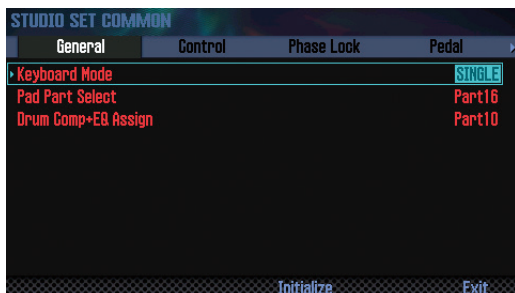

Parameter	Value	Explanation
-----------	-------	-------------

### General tab

Keyboard Mode	This specifies the play mode.	
	SINGLE	Single play
	SPLIT	Split play
	DUAL	Dual play
STUDIO SET	Multi part play	
Pad Part Select	Part1–Part16, OFF	Specifies the pad part (the part that records performance data from the pads).
Drum Comp+EQ Assign	Part1–Part16	Specifies the part that will use the six sets of compressor + equalizer that are provided for use with a drum kit. * If a tone (not a drum kit) is assigned to the part specified by Drum Comp+EQ Assign, the Comp+EQ will not be available.

### Control tab

Control Source Select (System)	SYSTEM, STUDIO SET	<b>SYSTEM:</b> The Control Source Select system parameters System Control 1–4 Source are used for tone control. <b>STUDIO SET:</b> Tone Control Src1–4 are used for tone control. * Control Source Select (System) settings are system parameters. * If you choose “ <b>SYSTEM</b> ,” the settings of the studio set parameters Tone Control Src1–4 are ignored.
Tone Control Src1–4	OFF, CC01–CC31, CC33–CC95, PICTH BEND, AFTERTOUCH	Specify the MIDI messages that will be used for Tone Control of the studio set.

### Phase Lock tab

Phase Lock (Ch1)–Phase Lock (Ch16)	OFF, ON	Set Phase Lock to “ <b>ON</b> ” when you want to suppress discrepancies in timing of parts played on the same MIDI channel. When the Phase Lock parameter is set to “ <b>ON</b> ,” parts on the same MIDI channel are put in a condition in which their timing is matched, enabling them to be played at the same time. Accordingly, a certain amount of time may elapse between reception of the Note messages and playing of the sounds. Turn this setting to “ <b>ON</b> ” only as needed. * Phase Lock is not available for SuperNATURAL acoustic organ-type instruments.
------------------------------------	---------	---

## Studio Set

Parameter	Value	Explanation
-----------	-------	-------------

### Pedal tab

Pedal Assign Source (System)	SYSTEM, STUDIO	Specifies whether the functions controlled by the pedals connected to the FOOT PEDAL CTRL 1 and 2 jacks will be determined by the system settings (SYSTEM) or by the studio set settings (STUDIO). * Pedal Assign Source (System) is a system parameter. * If you choose <b>"SYSTEM,"</b> the settings of the studio set parameters Pedal 1/2 Assign are ignored.
Pedal 1 Assign Pedal 2 Assign	Specify the functions that are controlled by pedals connected to the FOOT PEDAL CTRL 1 and 2 jacks.	
	OFF	No function is assigned.
	CC01–31, 32 (OFF), 33–95	Controller number 1–31, 32, 33–95
	BEND DOWN	The same effect as moving the pitch bend lever to the left.
	BEND UP	The same effect as moving the pitch bend lever to the right.
	AFTERTOUCH	Aftertouch

### S1/S2 tab

S1/S2 Assign Source (System)	SYSTEM, STUDIO	Specifies whether the functions controlled by the [S1] [S2] buttons will be determined by the system settings (SYSTEM) or by the studio set settings (STUDIO). * S1/S2 Assign Source (System) is a system parameter. * If you choose <b>"SYSTEM,"</b> the settings of the studio set parameters Switch S1/S2 Assign and Switch S1/S2 Assign Mode are ignored.
------------------------------	----------------	---

#### Assignable

Switch S1 Assign Switch S2 Assign	Specify the functions that are controlled by the [S1] [S2] buttons. Some of the SuperNATURAL acoustic tones let you use control changes to modify the character of the sound or switch to other variation sounds. For details, refer to <b>"SuperNATURAL Tone CC Assign"</b> (p. 118). *1: The Switch S1/2 Assign setting is fixed at <b>"LATCH."</b>	
	OFF	No function is assigned.
	CC01–31, 32 (OFF), 33–95	Controller number 1–31, 32, 33–95 CC16 (General-1)–CC19 (General-4) and CC80 (General-5)–CC83 (General-8) apply specific effects if a SuperNATURAL acoustic tone is selected (p. 118).
	AFTERTOUCH	Aftertouch
	MONO/POLY	Switch between mono/poly.
	CHORUS SWITCH *1	Turn the chorus on/off.
	REVERB SWITCH *1	Turn the reverb on/off.
	MASTER EQ SWITCH *1	Turn the master EQ on/off.
	TFX SWITCH *1	Turn the total effect on/off.
	MASTER KEY DOWN *1	Lower the keyboard range by a semitone.
MASTER KEY UP *1	Raise the keyboard range by a semitone.	
Switch S1 Mode Switch S2 Mode	LATCH	The setting is turned on/off each time you press the button.
	MOMENTARY	The setting is turned on while you hold down the button, and turned off when you release the button.

### Knob tab

Knob Assign Source (System)	SYSTEM, STUDIO	Specifies whether the functions controlled by the SOUND MODIFY knobs will be determined by the system settings (SYSTEM) or by the studio set settings (STUDIO). * Knob Assign Source (System) is a system parameter. * If you choose <b>"SYSTEM,"</b> the settings of the studio set parameters Sound Modify Knob 1–6 Assign are ignored.
Sound Modify Knob 1–6 Assign	Specify the functions that are controlled by the SOUND MODIFY knobs.	
	OFF	No function is assigned.
	CC01–31, 32 (OFF), 33–95	Controller number 1–31, 32, 33–95 CC16 (General-1)–CC19 (General-4) and CC80 (General-5)–CC83 (General-8) apply specific effects if a SuperNATURAL acoustic tone is selected (p. 118).
	PITCH BEND	Applies the same effect as when the pitch bend lever is moved.
	AFTERTOUCH	Aftertouch
	TFX PARAM 1–3	Controls parameters 1–3 of the Total Effect.

Parameter	Value	Explanation
-----------	-------	-------------

## D-Beam tab

D-Beam Assign Source (System)	SYSTEM, STUDIO	Specifies whether the functions controlled by the D-BEAM controller will be determined by the system settings (SYSTEM) or by the studio set settings (STUDIO). * D-Beam Assign Source (System) is a system parameter. * If you choose <b>"SYSTEM,"</b> the settings of the studio set parameters D-Beam Switch and Assignable are ignored.
D-Beam Switch	Specify the functions that are controlled by the D-BEAM controller.	
	OFF	No function is assigned.
	SOLO SYNTH	The D-BEAM controller operates as a monophonic synthesizer.
	EXPRESSION	The D-BEAM controller controls the volume.
	ASSIGNABLE	The D-BEAM controller controls the function that you assign.
<b>Solo Synth (System)</b>		
* The various Solo Synth (System) parameters are system parameters.		
Level	0-127	Adjusts the volume of the solo synth.
Chorus Send Level	0-127	Adjusts the chorus send level.
Reverb Send Level	0-127	Adjusts the reverb send level.
Range	2-8OCT	Adjusts the range in which the pitch of the solo synth will vary.
Osc 1 Waveform	SAW, SQR	Selects the waveform. SAW (sawtooth wave), SQR (square wave)
Osc 1 Pulse Width	0-127	Specifies the pulse width of the waveform. By cyclically modifying the pulse width you can create subtle changes in the tone.
Osc 1 Coarse Tune	-48-+48	Adjusts the pitch of the tone's sound (in semitones, +/-4 octaves).
Osc 1 Fine Tune	-50-+50	Adjusts the pitch of the tone's sound (in 1-cent steps).
Osc 2 Waveform	(same as Osc 1)	
Osc 2 Pulse Width		
Osc 2 Coarse Tune		
Osc 2 Fine Tune		
Osc 2 Level	0-127	Adjusts the level of the Osc 2.
Osc Sync Switch	OFF, ON	Turning this switch on produces a complex sound with many harmonics. This is effective when the Osc 1 pitch is higher than the Osc 2 pitch.
Filter Type	Specifies the type of filter.	
	OFF	No filter is used.
	LPF (Low Pass Filter)	This reduces the volume of all frequencies above the cutoff frequency (Cutoff).
	BPF (Band Pass Filter)	This leaves only the frequencies in the region of the cutoff frequency, and cuts the rest.
	HPF (High Pass Filter)	This cuts the frequencies in the region below the cutoff frequency.
	PKG (Peaking Filter)	This emphasizes the frequencies in the region of the cutoff frequency.
Cutoff	0-127	Frequency at which the filter begins to have an effect on the waveform's frequency components.
Resonance	0-127	Emphasizes the portion of the sound in the region of the cutoff frequency, adding character to the sound.
LFO Rate	0-127	Adjusts the modulation speed of the LFO.
LFO Osc 1 Pitch Depth	-63-+63	Specifies the depth to which the LFO will modulate the Osc 1 pitch.
LFO Osc 2 Pitch Depth	-63-+63	Specifies the depth to which the LFO will modulate the Osc 2 pitch.
LFO Osc 1 Pulse Width Depth	-63-+63	Specifies the depth to which the LFO will modulate the pulse width of the Osc 1 waveform. * The Pulse Width is activated when <b>"SQR"</b> is selected with Osc 1 waveform.
LFO Osc 2 Pulse Width Depth	-63-+63	Specifies the depth to which the LFO will modulate the pulse width of the Osc 2 waveform. * The Pulse Width is activated when <b>"SQR"</b> is selected with Osc 2 waveform.
<b>Assignable</b>		
D-Beam Assign	Specifies the function that is assigned to the D-Beam Switch <b>"ASSIGNABLE"</b> setting.	
	<b>MEMO</b> You can use the SOUND MODIFY knobs to control the <b>"CUTOFF"</b> - <b>"TFX CTRL"</b> parameters. You can also use the D-BEAM controller to control the same parameters.	
	OFF	No function is assigned.
	CC01-31, 32 (OFF), 33-95	Controller number 1-31, 32, 33-95 CC16 (General-1)-CC19 (General-4) and CC80 (General-5)-CC83 (General-8) apply specific effects if a SuperNATURAL acoustic tone is selected (p. 118).
	BEND DOWN	The same effect as moving the pitch bend lever to the left.
BEND UP	The same effect as moving the pitch bend lever to the right.	
AFTERTOUCH	Aftertouch	

## Studio Set

Parameter	Value	Explanation
D-Beam Assign	CUTOFF	Adjusts the cutoff frequency.
	RESONANCE	Adjusts the resonance.
	ATTACK	Adjusts the attack.
	RELEASE	Adjusts the release.
	PAN	Adjusts the pan.
	LEVEL	Adjusts the volume.
	EQ LOW	Adjusts the low frequency range.
	EQ MID1	Adjusts the mid-1 frequency range.
	EQ MID2	Adjusts the mid-2 frequency range.
	EQ MID3	Adjusts the mid-3 frequency range.
	EQ HIGH	Adjusts the high frequency range.
	INPUT LEVEL	Adjusts the input volume from the AUDIO INPUT jack.
	KNOB ASSIGN1-6	Adjust the [1] (ASSIGN 1)–[6] (ASSIGN 6) knobs.
	COMPRESSOR	Adjusts the compressor.
	TONE	Adjusts the tone.
	CHORUS	Adjusts the chorus.
	REVERB	Adjusts the reverb.
	TFX SELECT	Selects the total effect.
	TFX CTRL	Controls the total effect.
	SAMPLE PAD	Plays a sample.
Range Max	0–127	<p>Specifies the upper limit of the D-BEAM controller range.</p> <p>* This is shown only if D-Beam Assign is set to “CC,” “BEND DOWN,” “BEND UP,” or “AFTERTOUCH.”</p> <p><b>MEMO</b></p> <p>By setting the Range Max below the Range Min, you can invert the range of variation.</p>
Range Min	0–127	<p>Specifies the lower limit of the D-BEAM controller range.</p> <p>* This is shown only if D-Beam Assign is set to “CC,” “BEND DOWN,” “BEND UP,” or “AFTERTOUCH.”</p>
Beam Assign Knob Polarity	STANDARD, REVERSE	<p><b>STANDARD:</b> The assigned parameter changes in the positive (+) direction when you move your hand closer to the D-BEAM controller.</p> <p><b>REVERSE:</b> The assigned parameter changes in the negative (-) direction when you move your hand closer to the D-BEAM controller.</p> <p>* This is shown only if D-Beam Assign is set to “CUTOFF”–“TFX CTRL.”</p>
Beam Assign Sample Pad Number	1-1–4-16 (“Bank-Number” of the sample)	Selects the sample that plays if D-Beam Assign is set to “SAMPLE PAD.”

## Control Sw tab

Bend (Control Bender)	OFF, ON	For each controller, these settings specify whether MIDI messages are (ON) or are not (OFF) be transmitted to the part.
Mod (Control Modulation)		
Hold (Control Hold Pedal)		
Pedal1 (Control Pedal 1)		
Pedal2 (Control Pedal 2)		
D-Beam (Control DBeam)		
S1 (Control S1)		
S2 (Control S2)		



## PART VIEW

1. Press the [MENU] button.
2. Move the cursor to “Part View” and press the [ENTER] button.

The PART VIEW screen appears.



Parameter	Value	Explanation
-----------	-------	-------------

### Level/Pan tab

Type (Tone Type)	SN-A, SN-S, SN-D, PCMS, PCMD	Specifies the type of tone/drum kit assigned to each part. <b>SN-A:</b> SuperNATURAL Acoustic Tones <b>SN-S:</b> SuperNATURAL Synth Tones <b>SN-D:</b> SuperNATURAL Drum Kits <b>PCMS:</b> PCM Synth Tones <b>PCMD:</b> PCM Drum Kits
Bank (Tone Bank)	PRST, USER, GM2	Selects the group of the tone/drum kit assigned to each part. * You can select “GM2” if the tone type is PCMS or PCMD.
Number (Tone Number)	001–	Selects the number of the tone/drum kit assigned to each part.
Mute	OFF, ON	Specifies whether each part’s performance is temporarily muted (ON) or not muted (OFF). * The Mute parameter does not turn the part off; it mutes the sound by minimizing the volume. Therefore, the part still receives MIDI messages.
Solo	OFF, ON	Only the sound of the soloed part is heard.
Level	0–127	Adjust the volume of each part. This setting’s main purpose is to adjust the volume balance between parts.
Pan	L64–63R	Adjust the pan of each part. “L64” is far left, “0” is center, and “63R” is far right.
Sw (Rx Switch)	OFF, ON	For each part, specify whether MIDI messages will be received (ON), or not (OFF). If this is “OFF,” the part will not respond. Normally, you should leave this “ON,” but you can turn it “OFF” when you do not want a specific part to be playing during song playback.
Ch (Rx Channel)	1–16	Specifies the MIDI receive channel for each part.

### Keyboard tab

Kbd (Keyboard Switch)	OFF, ON	Turns each part’s keyboard switch on/off. * You can’t change this setting if the Keyboard Mode is “SINGLE,” “SPLIT,” or “DUAL.”
Arp (Arpeggio Switch)	OFF, ON	Turns each part’s arpeggio switch on/off. * You can’t change this setting if the Keyboard Mode is “SINGLE.”
R.L (Keyboard Range Lower)	C–G9	Specifies the lowest key of the keyboard range for each part. * You can’t change this setting if the Keyboard Mode is “SINGLE,” “SPLIT,” or “DUAL.”
R.U (Keyboard Range Upper)	C–G9	Specifies the highest key of the keyboard range for each part. * You can’t change this setting if the Keyboard Mode is “SINGLE,” “SPLIT,” or “DUAL.” <b>NOTE</b> If you raise the lowest key above the highest key, or the highest key below the lowest key, the other setting will change to the same value.

# Studio Set

Parameter	Value	Explanation
-----------	-------	-------------

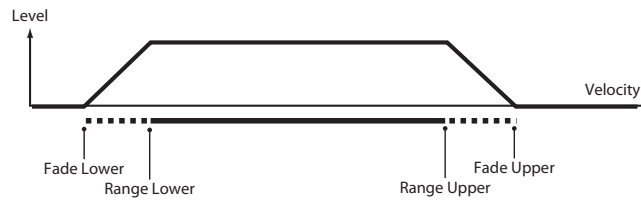

V.F.L (Velocity Fade Lower)	0–127	Determines what will happen to the tone's level when the tone is played at a velocity lower than Velocity Range Lower. If you don't want the tone to sound at all, set this parameter to "0."														
		<table border="1"> <thead> <tr> <th>SN-A (Ac. Piano)</th> <th>SN-A (Organ)</th> <th>SN-A (Other)</th> <th>SN-S</th> <th>SN-D</th> <th>PCMS</th> <th>PCMD</th> </tr> </thead> <tbody> <tr> <td>✓</td> <td>–</td> <td>✓</td> <td>✓</td> <td>✓</td> <td>✓</td> <td>✓</td> </tr> </tbody> </table>	SN-A (Ac. Piano)	SN-A (Organ)	SN-A (Other)	SN-S	SN-D	PCMS	PCMD	✓	–	✓	✓	✓	✓	✓
SN-A (Ac. Piano)	SN-A (Organ)	SN-A (Other)	SN-S	SN-D	PCMS	PCMD										
✓	–	✓	✓	✓	✓	✓										
V.L (Velocity Range Lower)	1–UPPER	Specifies the lowest velocity at which the part will sound.														
V.U (Velocity Range Upper)	LOWER–127	Specifies the highest velocity at which the part will sound.														
V.F.U (Velocity Fade Upper)	0–127	Determines what will happen to the tone's level when the tone is played at a velocity greater than Velocity Range Upper. If you don't want the tone to sound at all, set this parameter to "0."														
		<table border="1"> <thead> <tr> <th>SN-A (Ac. Piano)</th> <th>SN-A (Organ)</th> <th>SN-A (Other)</th> <th>SN-S</th> <th>SN-D</th> <th>PCMS</th> <th>PCMD</th> </tr> </thead> <tbody> <tr> <td>✓</td> <td>–</td> <td>✓</td> <td>✓</td> <td>✓</td> <td>✓</td> <td>✓</td> </tr> </tbody> </table>	SN-A (Ac. Piano)	SN-A (Organ)	SN-A (Other)	SN-S	SN-D	PCMS	PCMD	✓	–	✓	✓	✓	✓	✓
SN-A (Ac. Piano)	SN-A (Organ)	SN-A (Other)	SN-S	SN-D	PCMS	PCMD										
✓	–	✓	✓	✓	✓	✓										
Sens (Velocity Sens Offset)	-63–+63	Adjusts the velocity sensitivity. The higher the value, the greater the sensitivity.														
		<table border="1"> <thead> <tr> <th>SN-A (Ac. Piano)</th> <th>SN-A (Organ)</th> <th>SN-A (Other)</th> <th>SN-S</th> <th>SN-D</th> <th>PCMS</th> <th>PCMD</th> </tr> </thead> <tbody> <tr> <td>✓</td> <td>–</td> <td>–</td> <td>✓</td> <td>✓</td> <td>✓</td> <td>✓</td> </tr> </tbody> </table>	SN-A (Ac. Piano)	SN-A (Organ)	SN-A (Other)	SN-S	SN-D	PCMS	PCMD	✓	–	–	✓	✓	✓	✓
SN-A (Ac. Piano)	SN-A (Organ)	SN-A (Other)	SN-S	SN-D	PCMS	PCMD										
✓	–	–	✓	✓	✓	✓										

## Output/EFX tab

OUT (Output Assign)	MAIN, SUB	Specifies the output destination for each part. <b>MAIN:</b> Output to the MAIN OUTPUT jacks. <b>SUB:</b> Output to the SUB OUTPUT jack.
Cho (Chorus Send Level)	0–127	Adjusts the amount of chorus for each part. If you don't want to add the chorus effect, set it to 0.
Rev (Reverb Send Level)	0–127	Adjusts the amount of reverb for each part. If you don't want to add the reverb effect, set it to 0.

## EQ tab

Sw (EQ Switch)	OFF, ON	EQ for each part on/off setting
Low Freq (EQ Low Freq)	16, 20, 25, 31, 40, 50, 63, 80, 100, 125, 160, 200, 250, 315, 400, 500, 630, 800 Hz	Frequency of the low range.
Low Gain (EQ Low Gain)	-15–+15 dB	Gain of the low frequency range.
Mid Freq (EQ Mid Freq)	16, 20, 25, 31, 40, 50, 63, 80, 100, 125, 160, 200, 250, 315, 400, 500, 630, 800, 1000, 1250, 1600, 2000, 2500, 3150, 4000, 5000, 6300, 8000, 10000, 12500, 16000 Hz	Frequency of the middle range.
Mid Gain (EQ Mid Gain)	-15–+15 dB	Gain of the middle frequency range.
Q (EQ Mid Q)	0.5, 1.0, 2.0, 4.0, 8.0	Width of the middle frequency range. Set a higher value for Q to narrow the range to be affected.
High Freq (EQ High Freq)	630, 800, 1000, 1250, 1600, 2000, 2500, 3150, 4000, 5000, 6300, 8000, 10000, 12500, 16000 Hz	Frequency of the high range.
High Gain (EQ High Gain)	-15–+15 dB	Gain of the high frequency range.

Parameter	Value	Explanation
-----------	-------	-------------

### Pitch tab

Octave (Octave Shift)	-3+3	Adjusts the pitch of the part's sound up or down in units of an octave (+/-3 octaves). <table border="1" data-bbox="754 344 1495 443"> <thead> <tr> <th>SN-A (Ac. Piano)</th> <th>SN-A (Organ)</th> <th>SN-A (Other)</th> <th>SN-S</th> <th>SN-D</th> <th>PCMS</th> <th>PCMD</th> </tr> </thead> <tbody> <tr> <td>✓</td> <td>✓</td> <td>✓</td> <td>✓</td> <td>-</td> <td>✓</td> <td>-</td> </tr> </tbody> </table>	SN-A (Ac. Piano)	SN-A (Organ)	SN-A (Other)	SN-S	SN-D	PCMS	PCMD	✓	✓	✓	✓	-	✓	-
SN-A (Ac. Piano)	SN-A (Organ)	SN-A (Other)	SN-S	SN-D	PCMS	PCMD										
✓	✓	✓	✓	-	✓	-										
Coarse (Coarse Tune)	-48+48	Adjusts the pitch of the part's sound up or down in semitone steps (+/-4 octaves). * In some cases, specifying a setting greater than +2 octaves for a PCM drum kit tone may make the sound play backward.														
Fine (Fine Tune)	-50+50	Adjusts the pitch of the part's sound up or down in 1-cent steps (+/- 50 cents). * One cent is 1/100th of a semitone.														
Bend Range (Pitch Bend Range)	0-24, TONE	Specifies the amount of pitch change in semitones (up to 2 octaves) that will occur when the Pitch Bend Lever is moved. The amount of change when the lever is tilted is set to the same value for both left and right sides. If you want to use the Pitch Bend Range setting of the tone assigned to the part, set this to <b>"TONE."</b> <table border="1" data-bbox="754 728 1495 826"> <thead> <tr> <th>SN-A (Ac. Piano)</th> <th>SN-A (Organ)</th> <th>SN-A (Other)</th> <th>SN-S</th> <th>SN-D</th> <th>PCMS</th> <th>PCMD</th> </tr> </thead> <tbody> <tr> <td>✓</td> <td>✓</td> <td>✓</td> <td>✓</td> <td>-</td> <td>✓</td> <td>✓</td> </tr> </tbody> </table>	SN-A (Ac. Piano)	SN-A (Organ)	SN-A (Other)	SN-S	SN-D	PCMS	PCMD	✓	✓	✓	✓	-	✓	✓
SN-A (Ac. Piano)	SN-A (Organ)	SN-A (Other)	SN-S	SN-D	PCMS	PCMD										
✓	✓	✓	✓	-	✓	✓										
Porta Sw (Portamento Switch)	OFF, ON, TONE	Specify whether portamento will be applied. Turn this parameter <b>"ON"</b> when you want to apply Portamento and <b>"OFF"</b> when you don't. If you want to use the Portamento Switch setting of the tone assigned to the part, set this to <b>"TONE."</b> <table border="1" data-bbox="754 929 1495 1028"> <thead> <tr> <th>SN-A (Ac. Piano)</th> <th>SN-A (Organ)</th> <th>SN-A (Other)</th> <th>SN-S</th> <th>SN-D</th> <th>PCMS</th> <th>PCMD</th> </tr> </thead> <tbody> <tr> <td>✓</td> <td>-</td> <td>✓</td> <td>✓</td> <td>-</td> <td>✓</td> <td>-</td> </tr> </tbody> </table>	SN-A (Ac. Piano)	SN-A (Organ)	SN-A (Other)	SN-S	SN-D	PCMS	PCMD	✓	-	✓	✓	-	✓	-
SN-A (Ac. Piano)	SN-A (Organ)	SN-A (Other)	SN-S	SN-D	PCMS	PCMD										
✓	-	✓	✓	-	✓	-										
Porta Time (Portamento Time)	0-127, TONE	When portamento is used, this specifies the time over which the pitch will change. Higher settings will cause the pitch change to the next note to take more time. If you want to use the Portamento Time setting of the tone assigned to the part, set this to <b>"TONE."</b> <table border="1" data-bbox="754 1131 1495 1229"> <thead> <tr> <th>SN-A (Ac. Piano)</th> <th>SN-A (Organ)</th> <th>SN-A (Other)</th> <th>SN-S</th> <th>SN-D</th> <th>PCMS</th> <th>PCMD</th> </tr> </thead> <tbody> <tr> <td>✓</td> <td>-</td> <td>✓</td> <td>✓</td> <td>-</td> <td>✓</td> <td>-</td> </tr> </tbody> </table>	SN-A (Ac. Piano)	SN-A (Organ)	SN-A (Other)	SN-S	SN-D	PCMS	PCMD	✓	-	✓	✓	-	✓	-
SN-A (Ac. Piano)	SN-A (Organ)	SN-A (Other)	SN-S	SN-D	PCMS	PCMD										
✓	-	✓	✓	-	✓	-										

### Scale Tune tab

Type (Scale Tune Type)	CUSTOM, EQUAL, JUST-MAJ, JUST-MIN, PYTHAGORE, KIRNBERGE, MEANTONE, WERCKMEIS, ARABIC	These are templates that set all of the Scale Tune C-B settings. <b>CUSTOM:</b> Specify the tuning individually for Scale Tune C-B. <b>EQUAL:</b> Equal temperament <b>JUST-MAJ:</b> Just intonation (major) <b>JUST-MIN:</b> Just intonation (minor) <b>PYTHAGORE:</b> Pythagorean tuning <b>KIRNBERGE:</b> Kirnberger (type 3) <b>MEANTONE:</b> Meantone temperament <b>WERCKMEIS:</b> Werckmeister (type 1, number 3) <b>ARABIC:</b> Arabic scale <table border="1" data-bbox="754 1671 1495 1769"> <thead> <tr> <th>SN-A (Ac. Piano)</th> <th>SN-A (Organ)</th> <th>SN-A (Other)</th> <th>SN-S</th> <th>SN-D</th> <th>PCMS</th> <th>PCMD</th> </tr> </thead> <tbody> <tr> <td>✓</td> <td>-</td> <td>✓</td> <td>✓</td> <td>-</td> <td>✓</td> <td>✓</td> </tr> </tbody> </table>	SN-A (Ac. Piano)	SN-A (Organ)	SN-A (Other)	SN-S	SN-D	PCMS	PCMD	✓	-	✓	✓	-	✓	✓
SN-A (Ac. Piano)	SN-A (Organ)	SN-A (Other)	SN-S	SN-D	PCMS	PCMD										
✓	-	✓	✓	-	✓	✓										
Key (Scale Tune Key)	C, C#, D, D#, E, F, F#, G, G#, A, A#, B	Specifies the tonic note for the scale tune template. <table border="1" data-bbox="754 1832 1495 1930"> <thead> <tr> <th>SN-A (Ac. Piano)</th> <th>SN-A (Organ)</th> <th>SN-A (Other)</th> <th>SN-S</th> <th>SN-D</th> <th>PCMS</th> <th>PCMD</th> </tr> </thead> <tbody> <tr> <td>✓</td> <td>-</td> <td>✓</td> <td>✓</td> <td>-</td> <td>✓</td> <td>✓</td> </tr> </tbody> </table>	SN-A (Ac. Piano)	SN-A (Organ)	SN-A (Other)	SN-S	SN-D	PCMS	PCMD	✓	-	✓	✓	-	✓	✓
SN-A (Ac. Piano)	SN-A (Organ)	SN-A (Other)	SN-S	SN-D	PCMS	PCMD										
✓	-	✓	✓	-	✓	✓										
C-B (Scale Tune for C-B)	-64+63	Specifies the scale tuning. <table border="1" data-bbox="754 1993 1495 2092"> <thead> <tr> <th>SN-A (Ac. Piano)</th> <th>SN-A (Organ)</th> <th>SN-A (Other)</th> <th>SN-S</th> <th>SN-D</th> <th>PCMS</th> <th>PCMD</th> </tr> </thead> <tbody> <tr> <td>✓</td> <td>-</td> <td>✓</td> <td>✓</td> <td>-</td> <td>✓</td> <td>✓</td> </tr> </tbody> </table>	SN-A (Ac. Piano)	SN-A (Organ)	SN-A (Other)	SN-S	SN-D	PCMS	PCMD	✓	-	✓	✓	-	✓	✓
SN-A (Ac. Piano)	SN-A (Organ)	SN-A (Other)	SN-S	SN-D	PCMS	PCMD										
✓	-	✓	✓	-	✓	✓										

# Studio Set

Parameter	Value	Explanation
-----------	-------	-------------

## Vibrato tab

Rate (Vibrato Rate)	-64+63	<p>For each part, adjust the vibrato speed (the rate at which the pitch is modulated). The pitch will be modulated more rapidly for higher settings, and more slowly with lower settings.</p> <table border="1"> <thead> <tr> <th>SN-A (Ac. Piano)</th> <th>SN-A (Organ)</th> <th>SN-A (Other)</th> <th>SN-S</th> <th>SN-D</th> <th>PCMS</th> <th>PCMD</th> </tr> </thead> <tbody> <tr> <td>✓</td> <td>–</td> <td>✓</td> <td>✓</td> <td>–</td> <td>✓</td> <td>✓</td> </tr> </tbody> </table>	SN-A (Ac. Piano)	SN-A (Organ)	SN-A (Other)	SN-S	SN-D	PCMS	PCMD	✓	–	✓	✓	–	✓	✓
SN-A (Ac. Piano)	SN-A (Organ)	SN-A (Other)	SN-S	SN-D	PCMS	PCMD										
✓	–	✓	✓	–	✓	✓										
Depth (Vibrato Depth)	-64+63	<p>For each part, this adjusts the depth of the vibrato effect (the depth at which the pitch is modulated). The pitch will be modulated more greatly for higher settings, and less with lower settings.</p> <table border="1"> <thead> <tr> <th>SN-A (Ac. Piano)</th> <th>SN-A (Organ)</th> <th>SN-A (Other)</th> <th>SN-S</th> <th>SN-D</th> <th>PCMS</th> <th>PCMD</th> </tr> </thead> <tbody> <tr> <td>✓</td> <td>–</td> <td>✓</td> <td>✓</td> <td>–</td> <td>✓</td> <td>✓</td> </tr> </tbody> </table>	SN-A (Ac. Piano)	SN-A (Organ)	SN-A (Other)	SN-S	SN-D	PCMS	PCMD	✓	–	✓	✓	–	✓	✓
SN-A (Ac. Piano)	SN-A (Organ)	SN-A (Other)	SN-S	SN-D	PCMS	PCMD										
✓	–	✓	✓	–	✓	✓										
Delay (Vibrato Delay)	-64+63	<p>For each part, this adjusts the time delay until the vibrato (pitch modulation) effect begins. Higher settings will produce a longer delay time before vibrato begins, while lower settings produce a shorter time.</p> <table border="1"> <thead> <tr> <th>SN-A (Ac. Piano)</th> <th>SN-A (Organ)</th> <th>SN-A (Other)</th> <th>SN-S</th> <th>SN-D</th> <th>PCMS</th> <th>PCMD</th> </tr> </thead> <tbody> <tr> <td>✓</td> <td>–</td> <td>✓</td> <td>✓</td> <td>–</td> <td>✓</td> <td>✓</td> </tr> </tbody> </table>	SN-A (Ac. Piano)	SN-A (Organ)	SN-A (Other)	SN-S	SN-D	PCMS	PCMD	✓	–	✓	✓	–	✓	✓
SN-A (Ac. Piano)	SN-A (Organ)	SN-A (Other)	SN-S	SN-D	PCMS	PCMD										
✓	–	✓	✓	–	✓	✓										

## Offset tab

Cutoff (Cutoff Offset)	-64+63	<p>Adjusts the cutoff frequency for the tone/drum kit assigned to a part.</p> <table border="1"> <thead> <tr> <th>SN-A (Ac. Piano)</th> <th>SN-A (Organ)</th> <th>SN-A (Other)</th> <th>SN-S</th> <th>SN-D</th> <th>PCMS</th> <th>PCMD</th> </tr> </thead> <tbody> <tr> <td>–</td> <td>–</td> <td>✓*</td> <td>✓</td> <td>–</td> <td>✓</td> <td>✓</td> </tr> </tbody> </table> <p>* For some tones, the effect may be difficult to notice.</p>	SN-A (Ac. Piano)	SN-A (Organ)	SN-A (Other)	SN-S	SN-D	PCMS	PCMD	–	–	✓*	✓	–	✓	✓
SN-A (Ac. Piano)	SN-A (Organ)	SN-A (Other)	SN-S	SN-D	PCMS	PCMD										
–	–	✓*	✓	–	✓	✓										
Reso (Resonance Offset)	-64+63	<p>Adjusts the Resonance for the tone/drum kit assigned to a part.</p> <table border="1"> <thead> <tr> <th>SN-A (Ac. Piano)</th> <th>SN-A (Organ)</th> <th>SN-A (Other)</th> <th>SN-S</th> <th>SN-D</th> <th>PCMS</th> <th>PCMD</th> </tr> </thead> <tbody> <tr> <td>–</td> <td>–</td> <td>✓*</td> <td>✓</td> <td>–</td> <td>✓</td> <td>✓</td> </tr> </tbody> </table> <p>* For some tones, the effect may be difficult to notice.</p>	SN-A (Ac. Piano)	SN-A (Organ)	SN-A (Other)	SN-S	SN-D	PCMS	PCMD	–	–	✓*	✓	–	✓	✓
SN-A (Ac. Piano)	SN-A (Organ)	SN-A (Other)	SN-S	SN-D	PCMS	PCMD										
–	–	✓*	✓	–	✓	✓										
Attack (Attack Time Offset)	-64+63	<p>Adjusts the Attack Time for the tone/drum kit assigned to a part.</p> <table border="1"> <thead> <tr> <th>SN-A (Ac. Piano)</th> <th>SN-A (Organ)</th> <th>SN-A (Other)</th> <th>SN-S</th> <th>SN-D</th> <th>PCMS</th> <th>PCMD</th> </tr> </thead> <tbody> <tr> <td>–</td> <td>–</td> <td>✓</td> <td>✓</td> <td>–</td> <td>✓</td> <td>✓</td> </tr> </tbody> </table>	SN-A (Ac. Piano)	SN-A (Organ)	SN-A (Other)	SN-S	SN-D	PCMS	PCMD	–	–	✓	✓	–	✓	✓
SN-A (Ac. Piano)	SN-A (Organ)	SN-A (Other)	SN-S	SN-D	PCMS	PCMD										
–	–	✓	✓	–	✓	✓										
Decay (Decay Time Offset)	-64+63	<p>Adjusts the Decay Time for the tone/drum kit assigned to a part.</p> <table border="1"> <thead> <tr> <th>SN-A (Ac. Piano)</th> <th>SN-A (Organ)</th> <th>SN-A (Other)</th> <th>SN-S</th> <th>SN-D</th> <th>PCMS</th> <th>PCMD</th> </tr> </thead> <tbody> <tr> <td>–</td> <td>–</td> <td>–</td> <td>✓</td> <td>✓</td> <td>✓</td> <td>✓</td> </tr> </tbody> </table>	SN-A (Ac. Piano)	SN-A (Organ)	SN-A (Other)	SN-S	SN-D	PCMS	PCMD	–	–	–	✓	✓	✓	✓
SN-A (Ac. Piano)	SN-A (Organ)	SN-A (Other)	SN-S	SN-D	PCMS	PCMD										
–	–	–	✓	✓	✓	✓										
Release (Release Time Offset)	-64+63	<p>Adjusts the Release Time for the tone/drum kit assigned to a part.</p> <table border="1"> <thead> <tr> <th>SN-A (Ac. Piano)</th> <th>SN-A (Organ)</th> <th>SN-A (Other)</th> <th>SN-S</th> <th>SN-D</th> <th>PCMS</th> <th>PCMD</th> </tr> </thead> <tbody> <tr> <td>–</td> <td>–</td> <td>✓</td> <td>✓</td> <td>✓</td> <td>✓</td> <td>✓</td> </tr> </tbody> </table>	SN-A (Ac. Piano)	SN-A (Organ)	SN-A (Other)	SN-S	SN-D	PCMS	PCMD	–	–	✓	✓	✓	✓	✓
SN-A (Ac. Piano)	SN-A (Organ)	SN-A (Other)	SN-S	SN-D	PCMS	PCMD										
–	–	✓	✓	✓	✓	✓										

Parameter	Value	Explanation
-----------	-------	-------------

### Mono/Poly/Legato tab

Mono/Poly	MONO, POLY, TONE	Set this parameter to <b>"MONO"</b> when the tone assigned to the part is to be played monophonically, or to <b>"POLY"</b> when the tone is to be played polyphonically. If you want to use the Mono/Poly setting of the tone assigned to the part, set this to <b>"TONE."</b>												
		<table border="1"> <thead> <tr> <th>SN-A (Ac. Piano)</th> <th>SN-A (Organ)</th> <th>SN-A (Other)</th> <th>SN-S</th> <th>SN-D</th> <th>PCMS</th> <th>PCMD</th> </tr> </thead> <tbody> <tr> <td>✓</td> <td>-</td> <td>✓</td> <td>✓</td> <td>-</td> <td>✓</td> <td>-</td> </tr> </tbody> </table>	SN-A (Ac. Piano)	SN-A (Organ)	SN-A (Other)	SN-S	SN-D	PCMS	PCMD	✓	-	✓	✓	-
SN-A (Ac. Piano)	SN-A (Organ)	SN-A (Other)	SN-S	SN-D	PCMS	PCMD								
✓	-	✓	✓	-	✓	-								
Legato (Legato Switch)	OFF, ON, TONE	You can add legato when performing monophonically. The term <b>"legato"</b> refers to a playing style in which notes are smoothly connected to create a flowing feel. This creates a smooth transition between notes, which is effective when you wish to simulate the hammering-on and pulling-off techniques used by a guitarist.  Turn this parameter <b>"ON"</b> when you want to use the Legato feature and <b>"OFF"</b> when you don't. If you want to use the Legato Switch setting of the tone assigned to the part, set this to <b>"TONE."</b>												
		<table border="1"> <thead> <tr> <th>SN-A (Ac. Piano)</th> <th>SN-A (Organ)</th> <th>SN-A (Other)</th> <th>SN-S</th> <th>SN-D</th> <th>PCMS</th> <th>PCMD</th> </tr> </thead> <tbody> <tr> <td>✓</td> <td>-</td> <td>-</td> <td>✓</td> <td>-</td> <td>✓</td> <td>-</td> </tr> </tbody> </table>	SN-A (Ac. Piano)	SN-A (Organ)	SN-A (Other)	SN-S	SN-D	PCMS	PCMD	✓	-	-	✓	-
SN-A (Ac. Piano)	SN-A (Organ)	SN-A (Other)	SN-S	SN-D	PCMS	PCMD								
✓	-	-	✓	-	✓	-								

### Voice Reserve tab

VoiceRsv (Voice Reserve)	0-63, FULL	This setting specifies the number of voices that will be reserved for each part when more than 128 voices are played simultaneously.  It is not possible for the settings of all parts to total an amount greater than 64.
--------------------------	------------	--

### MIDI Rx Filter tab

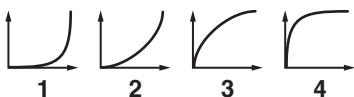
PC (Receive Program Change)	OFF, ON	For each MIDI channel, specify whether MIDI Program Change messages will be received <b>"ON"</b> , or not <b>"OFF."</b>														
BS (Receive Bank Select)	OFF, ON	For each MIDI channel, specify whether MIDI Bank Select messages will be received <b>"ON"</b> , or not <b>"OFF."</b>														
PB (Receive Pitch Bend)	OFF, ON	For each MIDI channel, specify whether MIDI Pitch Bend messages will be received <b>"ON"</b> , or not <b>"OFF."</b>														
PA (Receive Polyphonic Key Pressure)	OFF, ON	For each MIDI channel, specify whether MIDI polyphonic key pressure messages will be received <b>"ON"</b> , or not <b>"OFF."</b>														
CA (Receive Channel Pressure)	OFF, ON	For each MIDI channel, specify whether MIDI Channel Pressure messages will be received <b>"ON"</b> , or not <b>"OFF."</b>														
MD (Receive Modulation)	OFF, ON	For each MIDI channel, specify whether MIDI Modulation messages will be received <b>"ON"</b> , or not <b>"OFF."</b>														
VO (Receive Volume)	OFF, ON	For each MIDI channel, specify whether MIDI Volume messages will be received <b>"ON"</b> , or not <b>"OFF."</b>														
PN (Receive Pan)	OFF, ON	For each MIDI channel, specify whether MIDI Pan messages will be received <b>"ON"</b> , or not <b>"OFF."</b>														
EX (Receive Expression)	OFF, ON	For each MIDI channel, specify whether MIDI Expression messages will be received <b>"ON"</b> , or not <b>"OFF."</b>														
HD (Receive Hold-1)	OFF, ON	For each MIDI channel, specify whether MIDI Hold 1 messages will be received <b>"ON"</b> , or not <b>"OFF."</b>														
VC (Velocity Curve Type)	OFF, 1-4	Velocity Curve selects for each part one of the four following Velocity Curve types that best matches the touch of the connected MIDI keyboard. Set this to <b>"OFF"</b> if you are using the MIDI keyboard's own velocity curve.   <table border="1"> <thead> <tr> <th>SN-A (Ac. Piano)</th> <th>SN-A (Organ)</th> <th>SN-A (Other)</th> <th>SN-S</th> <th>SN-D</th> <th>PCMS</th> <th>PCMD</th> </tr> </thead> <tbody> <tr> <td>✓</td> <td>-</td> <td>✓</td> <td>✓</td> <td>✓</td> <td>✓</td> <td>✓</td> </tr> </tbody> </table>	SN-A (Ac. Piano)	SN-A (Organ)	SN-A (Other)	SN-S	SN-D	PCMS	PCMD	✓	-	✓	✓	✓	✓	✓
SN-A (Ac. Piano)	SN-A (Organ)	SN-A (Other)	SN-S	SN-D	PCMS	PCMD										
✓	-	✓	✓	✓	✓	✓										

# EFFECTS EDIT

1. Press the [MENU] button.
2. Move the cursor to “Effects Edit” and press the [ENTER] button.

The EFFECTS EDIT screen appears.

The EFFECTS EDIT screen shows the effect blocks and routing.

You can edit the values that are shown as red characters. To edit a value, move the cursor to that value and turn the dial.

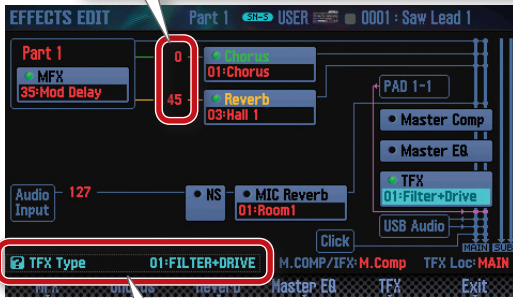

The currently selected parameter and its value are shown.

Parameter	Value	Explanation
MFX Switch	OFF, ON	Specifies whether multi-effect will be used (ON) or not used (OFF).
MFX Type	Selects the type of multi-effect (p. 93).	
Chorus Send Level	0–127	Adjusts the amount of chorus. If you don't want to add the chorus effect, set it to 0. * You can also set this in the Output/EFX tab of PART VIEW (p. 10).
Reverb Send Level	0–127	Adjusts the amount of reverb. If you don't want to add the reverb effect, set it to 0. * You can also set this in the Output/EFX tab of PART VIEW (p. 10).
Chorus Sw	OFF, ON	Switches the chorus on/off.
Reverb Sw	OFF, ON	Switches the reverb on/off.
Chorus Type	Selects the type of chorus (p. 68).	
Reverb Type	Selects the type of reverb (p. 68).	
Master Comp Switch	OFF, ON	Switches the master compressor on/off.
Master EQ Switch	OFF, ON	Switches the master EQ on/off.
TFX Sw	OFF, ON	Specifies whether total effect will be used (ON) or not used (OFF).
TFX Type	Selects the type of total effect (p. 20). * You can also set this in the TFX tab of SYSTEM EFFECTS (p. 19).	
IFX Part1–16 Switch *1	OFF, ON	Switches each part's insert effect on/off.
IFX Sw *1	OFF, ON	Switches the insert effect on/off.
IFX Type *1	Selects the type of insert effect (p. 69).	
IFX Chorus Send Level *1	0–127	Adjusts the amount of chorus. If you don't want to add the chorus effect, set it to 0.
IFX Reverb Send Level *1	0–127	Adjusts the amount of reverb. If you don't want to add the reverb effect, set it to 0.
Drum Comp/EQ Switch *2	OFF, ON	Turns the six drum kit compressor + equalizer units on/off together.
Audio Input Level	0–127	Adjusts the input volume of the AUDIO INPUT jack.
NS Switch	OFF, ON	Switches the noise suppressor on/off.
Input Reverb Switch	OFF, ON	Switches the microphone input reverb on/off.
Input Reverb Type	Selects the type of microphone input reverb (p. 18).	
M.COMP/IFX Select	M. Comp (Master Comp), IFX	Selects whether to use the master compressor (M.Comp) or the insert effect (IFX).
TFX Location	MAIN, Input	Selects whether the total effect is applied to the sounds that you play from the keyboard (MAIN) or to the sound being input via the AUDIO INPUT jack (Input).

\*1: This is shown only if M.COMP/IFX Select is set to “IFX.”

\*2: This is shown only if you've selected the part specified by Drum Comp+EQ Assign.

## STUDIO SET EFFECTS

1. Access the EFFECTS EDIT screen (p. 14).
2. Press the button for the studio set effect that you want to edit.

Button	Explanation
[3] (Chorus)	Edits the chorus settings.
[4] (Reverb)	Edits the reverb settings.
[SHIFT] + [3] (Comp+EQ Output)	Specifies the output destination of the drum part's compressor and equalizer. * This is valid only if the tone of the part specified by Drum Comp+EQ Assign is either PCMD or SN-D.
[SHIFT] + [7] (Master Comp)	Applies a final adjustment (compression) to the overall sound of the studio set. * When M.COMP/IFX Select is set to "Master Comp."
[SHIFT] + [7] (IFX)	Edits the insert effect settings. * When M.COMP/IFX Select is set to "IFX."

The STUDIO SET EFFECTS screen appears.

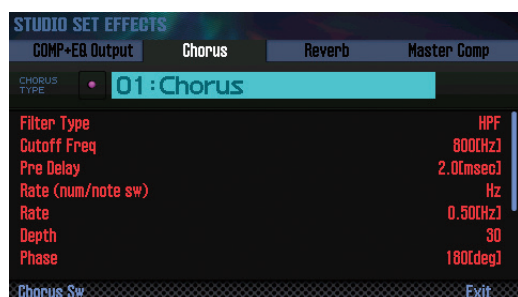

Parameter	Value	Explanation
-----------	-------	-------------

### Chorus tab

Chorus Switch ([2] (Chorus Sw) button)	OFF, ON	Switches the chorus on/off.
Chorus Type	00: OFF 01: Chorus 02: Delay 03: GM2 Chorus	Selects the types of chorus. Choose "00: OFF" if you don't want to apply a chorus.
Chorus Parameter	-	Edit the parameters for the selected chorus type. Refer to "Chorus Parameters" (p. 68).
Chorus Level	0-127	Adjusts the volume of the sound that has passed through chorus.
Chorus Output Assign	MAIN, SUB	Selects the pair of OUTPUT jacks to which the chorus sound is routed when Chorus Output Select is set to "MAIN" or "MAIN+REV."
Chorus Output Select	MAIN, REV, MAIN+REV	Specifies how the sound routed through chorus will be output. <b>MAIN:</b> Output to the OUTPUT jacks. <b>REV:</b> Output to the reverb. <b>MAIN+REV:</b> Output to the OUTPUT jacks and the reverb.

### Reverb tab

Reverb Switch ([2] (Reverb Sw) button)	OFF, ON	Switches the reverb on/off.
Reverb Type	00: OFF 01: Room 1 02: Room 2 03: Hall 1 04: Hall 2 05: Plate 06: GM2 Reverb	Selects the types of reverb. Choose "00: OFF" if you don't want to apply a reverb.
Reverb Parameter	-	Edit the parameters for the selected reverb type. Refer to "Reverb Parameters" (p. 68).
Reverb Level	0-127	Adjusts the volume of the sound that has passed through reverb.
Reverb Output Assign	MAIN, SUB	Specifies how the sound routed through reverb will be output. The sound is output in stereo from the MAIN OUTPUT jacks, or from the SUB OUTPUT jack.

## EFFECTS EDIT

Parameter	Value	Explanation
-----------	-------	-------------

### Comp+EQ Output tab

\* This is shown only if the tone of the part specified by Drum Comp+EQ Assign is PCMD or SN-D.

Comp+EQ 1 Output Assign	PART, SUB	Specify the output destination for each the six drum kit compressor + equalizer units. <b>PART:</b> Input to the MFX of the part. <b>SUB:</b> Output in stereo to the SUB OUTPUT jack.
Comp+EQ 2 Output Assign		
Comp+EQ 3 Output Assign		
Comp+EQ 4 Output Assign		
Comp+EQ 5 Output Assign		
Comp+EQ 6 Output Assign		

### Master Comp tab

\* This is shown only if M.COMP/IFX Select is set to "Master Comp."

M.Comp Sw ([2] (M.Comp Sw) button)	OFF, ON	Switches the master compressor on/off.	
Low band Attack time	0–100	Low band	Time from when the input exceeds the Threshold until compression begins
Low band Release time	0–100		Time from when the input falls below the Threshold until compression is removed
Low band Threshold	-36–0 dB		Level at which compression is applied
Low band Ratio	1:1.0–1:INF		Compression ratio
Low band Level	0–24 dB		Level of the output sound
Mid band Attack time	0–100		Middle band
Mid band Release time	0–100	Time from when the input falls below the Threshold until compression is removed	
Mid band Threshold	-36–0 dB	Level at which compression is applied	
Mid band Ratio	1:1.0–1:INF	Compression ratio	
Mid band Level	0–24 dB	Level of the output sound	
High band Attack time	0–100	High band	
High band Release time	0–100		Time from when the input falls below the Threshold until compression is removed
High band Threshold	-36–0 dB		Level at which compression is applied
High band Ratio	1:1.0–1:INF		Compression ratio
High band Level	0–24 dB		Level of the output sound
Split Freq Low	200–800 Hz		Frequency at which the low and mid bands are divided
Split Freq High	2000–8000 Hz	Frequency at which the mid and high bands are divided	

### IFX tab

\* This is shown only if M.COMP/IFX Select is set to "IFX."

IFX Sw ([2] (IFX Sw) button)	OFF, ON	Switches the insert effect on/off.	
IFX Type	00–78	Use this parameter to select from among the 78 available insert effect. For details on insert effect parameters, refer to "IFX Parameters" (p. 69).	
IFX Chorus Send Level	0–127	Adjusts the amount of chorus. If you don't want to add the chorus effect, set it to 0.	
IFX Reverb Send Level	0–127	Adjusts the amount of reverb. If you don't want to add the reverb effect, set it to 0.	
IFX Output Assign	MAIN, SUB	Specifies the output destination of the sound that passes through the insert effect. The sound is output in stereo from the MAIN OUTPUT jacks, or from the SUB OUTPUT jack.	
Parameters for each IFX type	Edit the parameters for the selected IFX type.		



## TONE EFFECTS (MFX, COMP+EQ)

1. Access the EFFECTS EDIT screen (p. 14).
2. Press the button for the tone effect that you want to edit.

Button	Explanation
[2] (MFX)	Edits the MFX (multi-effect) settings. Refer to “ <b>MFX Parameters</b> ” (p. 93).
[SHIFT] + [2] (Comp+EQ)	Edits the compressor and equalizer of the drum part. For details, refer to the parameters of each tone. * This is valid only if the tone of the part specified by Drum Comp+EQ Assign is either PCMD or SN-D.

The TONE EDIT screen appears.

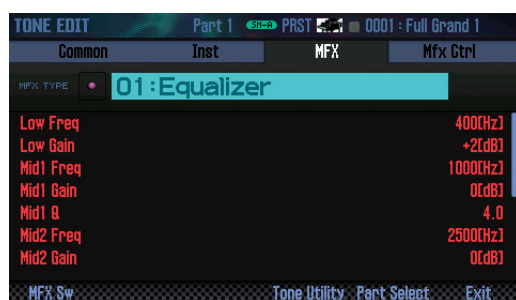

- \* You can edit MFX and COMP+EQ individually for each tone.

## SYSTEM EFFECTS

1. Access the EFFECTS EDIT screen (p. 14).
2. Press the button for the system effect that you want to edit.

Button	Explanation
[5] (Master EQ)	Edits the equalizer that is applied to the entire sound engine of the FA.
[6] (TFX)	Edits the TFX (total effect) settings.
[SHIFT] + [4] (Input)	Specifies the input volume from the AUDIO INPUT jack.
[SHIFT] + [5] (NS)	Edits the noise suppressor settings.
[SHIFT] + [6] (MIC Reverb)	Applies reverb to the microphone or other device that's connected to the AUDIO INPUT jack.

The SYSTEM EFFECTS screen appears.

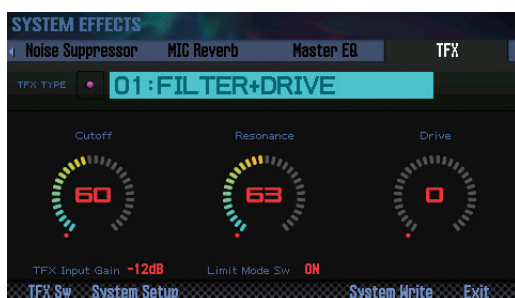

Parameter	Value	Explanation
-----------	-------	-------------

### Audio Input tab

Audio Input Level	0–127	Specifies the input volume of the device that is connected to the AUDIO INPUT jacks.
Audio Input Output Assign	MAIN, SUB	Specifies the output destination of the sound that is input from the AUDIO INPUT jack. <b>MAIN:</b> Output to the MAIN OUTPUT jacks. <b>SUB:</b> Output to the SUB OUTPUT jack.

### USB Audio tab

USB Audio Input Level	0–127	Specifies the input volume of the device that is connected to the USB COMPUTER port.
USB Audio Input Destination	MAIN, SUB, TFX	Specifies the output destination of the sound that is input from the USB COMPUTER port. <b>MAIN:</b> Output to the MAIN OUTPUT jacks. <b>SUB:</b> Output to the SUB OUTPUT jack. <b>TFX:</b> Output to a point before the total effect. By setting TFX Location to <b>"MAIN,"</b> you can apply the total effect to the sound of the USB Audio Input.
USB Audio Output Select	MAIN, INPUT, INPUT-EFX	Specifies the USB audio sound that is output from the USB COMPUTER port. <b>MAIN:</b> The same sound as the output from the MAIN OUTPUT jacks is output from the USB COMPUTER port. <b>INPUT:</b> The sound that is input from the AUDIO INPUT jack is output without change from the USB COMPUTER port. <b>INPUT-EFX:</b> The sound that is input from the AUDIO INPUT jack is processed by the noise suppressor (NS) and microphone reverb (MIC Reverb) and then output from the USB COMPUTER jack. You can apply the total effect by setting TFX Location to <b>"Input."</b>

### Noise Suppressor tab

NS Sw ([2] (NS Sw) button)	OFF, ON	Switches the noise suppressor on/off.
NS Threshold	0–127	Adjusts the volume at which noise suppression starts to be applied.
NS Release	0–127	Adjusts the time from when noise suppression starts until the volume reaches 0.

### MIC Reverb tab

MIC Rev Sw ([2] (MIC Rev Sw) button)	OFF, ON	Switches the reverb on/off.
Input Reverb Type	ROOM1, ROOM2, STAGE1, STAGE2, HALL1, HALL2, DELAY, PAN-DELAY	Selects the type of reverb.
Input Reverb Time	0–127	Adjusts the decay length of the reverb sound.
Input Reverb Level	0–127	Adjusts the volume of the sound that has passed through reverb.

Parameter	Value	Explanation
-----------	-------	-------------

## Master EQ tab

M.EQ Sw ([2] (M.EQ Sw) button)	OFF, ON	Switches the master EQ on/off.
EQ Input Gain	-15→+15 dB	Adjusts the input gain of the master EQ.
EQ Low Freq	16–800 Hz	Frequency of the low range.
EQ Low Gain	-15→+15 dB	Gain of the low frequency range.
EQ Mid1 Freq	16–16000 Hz	Frequency of the middle range 1.
EQ Mid1 Gain	-15→+15 dB	Gain of the middle frequency range 1.
EQ Mid1 Q	0.5, 1.0, 2.0, 4.0, 8.0	Width of the middle frequency range 1. Set a higher value for Q to narrow the range to be affected.
EQ Mid2 Freq	16–16000 Hz	Frequency of the middle range 2.
EQ Mid2 Gain	-15→+15 dB	Gain of the middle frequency range 2.
EQ Mid2 Q	0.5, 1.0, 2.0, 4.0, 8.0	Width of the middle frequency range 2. Set a higher value for Q to narrow the range to be affected.
EQ Mid3 Freq	16–16000 Hz	Frequency of the middle range 3.
EQ Mid3 Gain	-15→+15 dB	Gain of the middle frequency range 3.
EQ Mid3 Q	0.5, 1.0, 2.0, 4.0, 8.0	Width of the middle frequency range 3. Set a higher value for Q to narrow the range to be affected.
EQ High Freq	630–16000 Hz	Frequency of the high range.
EQ High Gain	-15→+15 dB	Gain of the high frequency range.

## TFX tab

TFX Sw ([2] (TFX Sw) button)	OFF, ON	Specifies whether total effect will be used (ON) or not used (OFF).
TFX Type	00–29	Use this parameter to select from among the 29 available total effect. For details on total effect parameters, refer to “ <a href="#">TFX Parameters</a> ” (p. 20).
Parameters for each TFX type	Edit the parameters for the selected TFX type.	
TFX Input Gain	-18–0 dB	Simultaneously adjusts the input and output gain of the total effect. This is convenient when adjusting dynamics-type effects (such as overdrive or compressor) that produce their effect by varying the volume. For some effects, it may be difficult to notice the result of this adjustment.
Limit Mode Sw	OFF, ON	If you turn Limit Mode on, the effect depth is restricted to prevent feedback or an extremely high volume. Parameters that are affected by Limit Mode are indicated by a ★ symbol. This can be convenient when you’re performing in high-volume conditions at a club or hall.

## TFX Parameters

Parameters that are affected by Limit Mode are indicated by a ★ symbol.

Parameter	Value	Explanation
-----------	-------	-------------

### 01: FILTER+DRIVE

A low-pass filter with overdrive. It cuts the high frequencies and adds distortion.

Cutoff	0–127	Adjusts the frequency that will be cut.
Resonance ★	0–127	Adjusts peak frequency response at the cutoff frequency.
Drive ★	0–127	Adds distortion.

### 02: ISOLATOR

Isolates or removes the low, mid, or high frequency ranges.

Low ★	0–127	Isolates/removes the low-frequency range.
Mid ★	0–127	Isolates/removes the mid-frequency range.
High ★	0–127	Isolates/removes the high-frequency range.

### 03: DJFX LOOPER

Loops a short portion of the input sound. You can vary the playback direction and playback speed of the input sound to add turntable-type effects.

Length ★	0–127	Specifies the length of the loop.
Speed	-1.0–+1.0	Specifies the playback direction and playback speed. Turning the knob to the left of 12 o'clock plays in reverse; turning the knob to the right of 12 o'clock plays forward. Playback stops if the knob is at 12 o'clock.
Loop Sw	OFF, ON	If you turn this on while sound is playing, the sound at that point will be looped. Turn this off to cancel the loop.

### 04: BPM LOOPER

Loops the input sound over a short period.

Length ★	0–127	Adjusts the length of the loop.
Timing	OFF, 1–8	Specifies the timing (in 8th note units) at which sounds looped during a measure will automatically start playing. If you don't want the loop to play automatically, turn this "OFF"
Loop Sw	OFF, ON	If you turn this on while the sound is heard, the sound at that point will be looped. Turn this off to defeat looping.

### 05: BIT CRUSH

Produces an extreme lo-fi effect.

Sample Rate	0–127	Adjusts the sample rate.
Bit ★	0–127	Adjusts the bit depth.
Filter	0–127	Adjusts the filter depth.

### 06: WAH

Produces a wah effect.

Peak	0–127	Adjusts the width of frequencies to which effect is applied.
Rate	0–127	Adjust the speed of modulation.
Manual	0–127	Adjusts the pitch of the effect sound.

### 07: REVERB

Adds reverberation to the sound.

Reverb Time	0–127	Adjusts the reverberation time.
Tone	0–127	Adjusts the tone of the reverberation.
Balance	0–127	Adjusts the volume balance between the direct sound and effect sound.

### 08: DELAY

Repeats the sound.

Delay Time	Note *1	Adjusts the interval of the repeats.
Feedback ★	0–127	Adjusts the number of the repeats.
Balance	D64–63E	Adjusts the volume balance between the direct sound and effect sound.

### 09: TAPE ECHO

Simulates a tape-type echo unit of the past.

Rate	0–127	Specifies the tape speed.
Intensity	0–127	Specifies the amount of echo repeat.
Balance	D64–63E	Adjusts the volume balance between the direct sound and effect sound.

Parameter	Value	Explanation
-----------	-------	-------------

## 10: PITCH SHIFTER

Changes the pitch.

Pitch	0–127	Adjusts the amount of pitch change.
Feedback ★	0–127	Adjusts the amount of pitch-shifted sound that is fed back.
Balance	D64–63E	Adjusts the volume balance between the direct sound and effect sound.

## 11: VOICE TRANS

Processes a human voice to create a variety of characters.

Formant	0–127	Adjusts the character (formant) of the voice.
Effect Level	0–127	Adjusts the volume of the effect sound.
Direct Level	0–127	Adjusts the volume of the direct sound.

## 12: FLANGER

Creates modulation reminiscent of a jet airplane taking off and landing.

Depth	0–127	Adjusts the depth of modulation.
Rate	0–127	Adjusts the speed of modulation.
Feedback ★	0–127	Adjusts the proportion of effect sound that is returned to the input.
Balance	D64–63E	Adjusts the volume balance between the direct sound and effect sound.

## 13: SLICER+FLG

Repeatedly cuts the sound. A flanger is added.

Timing Pattern	P01–P16 *2	The timing at which the sound is cut.
Rate	Note *1	Adjusts the length of Timing Pattern.
Feedback ★	0–127	Adjusts the flanger depth.
Attack	0–127	Adjusts the speed at which the level will change between steps.

## 14: PHASER

Creates modulation by adding a phase-shifted sound.

Depth ★	0–127	Adjusts the depth of modulation.
Rate	0–127	Adjusts the speed of modulation.
Manual	0–127	Adjusts the pitch of the effect sound.
Balance	D64–63E	Adjusts the volume balance between the direct sound and effect sound.

## 15: CHORUS

Adds spaciousness and richness to the sound.

Depth	0–127	Adjusts the depth of modulation.
Rate	0–127	Adjusts the rate of modulation.
Balance	D64–63E	Adjusts the volume balance between the direct sound and effect sound.

## 16: TREMOLO/PAN

Cyclically varies the volume or panning.

Depth	0–127	Adjusts the amount of change in volume/panning.
Rate	0–127	Adjusts the speed of volume/panning change.
Waveform	TRM, PAN	Switches the curve of the cyclic change in volume (TRM) / panning (PAN).

## 17: OVERDRIVE

Mildly distorts the sound.

Drive ★	0–127	Adjusts the degree of distortion.
Tone ★	0–127	Adjusts the tone.
Level ★	0–127	Adjusts the volume.

## 18: DISTORTION

Intensely distorts the sound.

Drive ★	0–127	Adjusts the degree of distortion.
Tone ★	0–127	Adjusts the tone.
Level ★	0–127	Adjusts the volume.

## 19: FUZZ

Adds overtones and intensely distorts the sound.

Drive ★	0–127	Adjusts the degree of distortion.
Tone ★	0–127	Adjusts the tone.
Level ★	0–127	Adjusts the volume.

## EFFECTS EDIT

Parameter	Value	Explanation
-----------	-------	-------------

### 20: OCTAVE

Adds a pitch at lower octaves.

-2 Oct Level	0–127	Adds a pitch two octaves below.
-1 Oct Level	0–127	Adds a pitch one octave below.
Direct Level	0–127	Adjusts the volume of the direct sound.

### 21: SUBSONIC

Adds a low-frequency sine wave based on the volume being input to the effect (\*3).

Pitch	0–127	Adjusts the frequency of the sine wave.
Threshold	0–127	Adjusts the volume at which the sine wave will begin sounding.
Balance	D64–63E	Adjusts the volume balance between the direct sound and effect sound.

### 22: RING MOD

Gives the sound a metallic character.

Frequency ★	0–127	Adjusts the pitch of the metallic sound.
Sens ★	0–127	Adjusts the depth to which the frequency is modulated.
Balance	D64–63E	Adjusts the volume balance between the direct sound and effect sound.

### 23: CHROMATIC PS

A two-voice pitch shifter that changes the pitch in semitone steps.

Pitch1	-12–+12	Changes pitch 1 in semitone steps over a +/-1 octave range.
Pitch2	-12–+12	Changes pitch 2 in semitone steps over a +/-1 octave range.
Balance	D64–63E	Adjusts the volume balance between the direct sound and effect sound.

### 24: C. CANCELLER

Cancels the vocal or other sound located in the center.

L-R Balance	L64–63R	Adjusts the point at which maximum cancellation occurs.
Low Boost	0–127	Boosts the low-frequency sounds located in the center, such as the bass.
High Boost	0–127	Boosts the high-frequency sounds.

### 25: VINYL SIM

Simulates sound heard from an analog record.

Frequency Range	0–127	Adjusts the frequency response of the playback system.
Noise Level	0–127	Adjusts the volume of noise.
Wow/Flutter	0–127	Adjusts the rotational instability of the analog record.

### 26: RADIO TUNING

Simulates sound heard from a radio.

Detune	0–127	Adjusts the tuning drift of the radio.
Noise Level	0–127	Adjusts the volume of noise.
Balance	D64–63E	Adjusts the volume balance between the direct sound and effect sound.

### 27: NOISE GEN

Applies a lo-fi effect, and also adds noises such as white noise and record noise.

White Noise	0–127	Adjusts the volume of the “hiss” noise.
Disc Noise	0–127	Adjusts the volume of the “pop” noise.
Hum Noise	0–127	Adjusts the volume of the “hum” noise.

### 28: COMP

Makes the sound more consistent.

Sustain	0–127	Adjusts the depth of the compressor.
Attack ★	0–127	Adjusts the attack. If Limit mode is on, this adjusts the release.
Level ★	0–127	Adjusts the volume.

### 29: EQUALIZER

Adjusts the volume of each frequency region.

Low ★	0–127	Adjusts the low-frequency volume.
Mid ★	0–127	Adjusts the mid-frequency volume.
High ★	0–127	Adjusts the high-frequency volume.

\*1: This setting is specified as a note value relative to the sequencer's tempo.

Note values that you can specify:

	Thirty-second note		Sixteenth note		Eighth-note triplet		Dotted sixteenth note
	Eighth note		Quarter-note triplet		Dotted eighth note		Quarter note
	Half-note triplet		Dotted quarter note		Half note		Dotted half note
	Whole note						

However, you can't select a setting that would cause the delay time to exceed approximately 2,000 msec.

\*2: Choose from the following Timing Patterns.

P01	P09
P02	P10
P03	P11
P04	P12
P05	P13
P06	P14
P07	P15
P08	P16

The cycle of the Timing Pattern is based on a 4/4 time signature.

If the sequencer is set to a time signature other than 4/4, unexpected results may occur.

You can use Rate to adjust the synchronization speed as follows.

Rate maximum: One cycle of Timing Pattern corresponds to one measure.

Rate minimum: One cycle of Timing Pattern corresponds to a 32nd note.

By changing the Rate setting you can change the cycle in the range between a 32nd note to one full measure.

\*3: Set the Balance at about 12 o'clock, turn Pitch all the way to the right, and set Threshold so that the sine wave is heard appropriately for the input source. After you've finished setting the Threshold, adjust the Pitch and Balance. This is a useful way to strengthen a kick drum.

# SuperNATURAL Acoustic Tone (SN-A)

## TONE EDIT (SN-A)

For each tone, there are instrument settings (Inst) and multi-effect settings (MFX). The instrument settings let you make settings for the tone and its parameters.

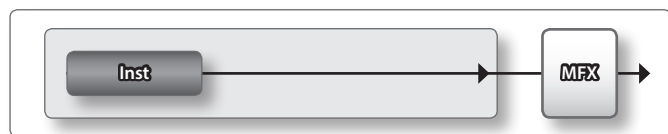

1. Select the part to which the tone is assigned.
2. Press the **[MENU]** button.
3. Move the cursor to **“Tone Edit”** and press the **[ENTER]** button.

Parameter	Value	Explanation
-----------	-------	-------------

### Common tab

Category	No Assign, Ac.Piano, Pop Piano, E.GrandPiano, E.Piano1, E.Piano2, E.Organ, Pipe Organ, Reed Organ, Harpsichord, Clav, Celesta, Accordion, Harmonica, Bell, Mallet, Ac.Guitar, E.Guitar, Dist.Guitar, Ac.Bass, E.Bass, Synth Bass, Plucked/Stroke, Solo Strings, Ens.Strings, Orhestral, Solo Brass, Ens.Brass, Wind, Flute, Sax, Recorder, Vox/Choir, Scat, Synth Lead, Synth Brass, Synth Pad/Str, Synth Bellpad, Synth PolyKey, Synth FX, Synth Seq/Pop, Phrase, Pulsating, Beat&Groove, Hit, Sound FX, Drums, Percussion, Stack, Zone	Selects the category of the tone.
Phrase Number	0-87	Number of the phrase that plays when you press the <b>[PREVIEW]</b> button.
Phrase Octave Shift	-3+3	Pitch (in one-octave units) of the preview phrase.
Tone Level	0-127	Adjusts the volume of the tone.
Mono/Poly	MONO, POLY	Specifies whether the tone will play polyphonically (POLY) or monophonically (MONO). <b>MONO:</b> Only the last-played note will sound. <b>POLY:</b> Two or more notes can be played simultaneously. * This parameter will not appear when 024: TW Organ is selected.
Octave Shift	-3+3	Adjusts the pitch of the tone's sound up or down in units of an octave (+/-3 octaves).
Bend Mode	NORMAL, CATCH+LAST	<b>NORMAL:</b> The pitch bend lever works in the conventional way. <b>CATCH+LAST:</b> The pitch lever affects only the last-sounded note. If you play a note while the pitch bend lever is already moved, that note sounds at its normal pitch (as though the lever were in the center). The pitch starts changing only after the lever passes through the center position. * This is effective when the instrument is a guitar sound or bass sound.
Cutoff Offset	-64+63	Adjusts the cutoff frequency Offset for the instrument assigned to a tone. * This parameter will not appear when any of 001: Concert Grand-009: Honky-tonk, or 024: TW Organ is selected.
Resonance Offset	-64+63	Adjusts the Resonance Offset for the instrument assigned to a tone. * This parameter will not appear when any of 001: Concert Grand-009: Honky-tonk, or 024: TW Organ is selected.
Attack Time Offset	-64+63	Adjusts the TVA Envelope Attack Time Offset for the instrument assigned to a tone. * This parameter will not appear when any of 001: Concert Grand-009: Honky-tonk, or 024: TW Organ is selected.
Release Time Offset	-64+63	Adjusts the TVA Envelope Release Time Offset for the instrument assigned to a tone. * This parameter will not appear when any of 001: Concert Grand-009: Honky-tonk, or 024: TW Organ is selected.
Portamento Time Offset	-64+63	When portamento is used, this specifies the time over which the pitch will change. Higher settings will cause the pitch change to the next note to take more time. * This parameter will not appear when 024: TW Organ is selected.
Vibrato Rate	-64+63	Adjust the vibrato speed (the rate at which the pitch is modulated). The pitch will be modulated more rapidly for higher settings, and more slowly with lower settings. * This effect does not apply if the instrument is 024: TW Organ.



Parameter	Value	Explanation
Vibrato Depth	-64+63	This adjusts the depth of the vibrato effect (the depth at which the pitch is modulated). The pitch will be modulated more greatly for higher settings, and less with lower settings. * This effect does not apply if the instrument is 024: TW Organ.
Vibrato Delay	-64+63	This adjusts the time delay until the vibrato (pitch modulation) effect begins. Higher settings will produce a longer delay time before vibrato begins, while lower settings produce a shorter time. * This effect does not apply if the instrument is 024: TW Organ.

## Inst tab

Inst	001-	Select the instrument number of the tone.
Parameters for the each inst	Make parameter settings for the selected instrument. Refer to <b>"SuperNATURAL Inst Parameters"</b> (p. 26).	

## Instrument List

Inst	
No.	Name
1	Concert Grand
2	Grand Piano1
3	Grand Piano2
4	Grand Piano3
5	Mellow Piano
6	Bright Piano
7	Upright Piano
8	Concert Mono
9	Honky-tonk
10	Pure Vintage EP1
11	Pure Vintage EP2
12	Pure Wurly
13	Pure Vintage EP3
14	Old Hammer EP
15	Dyno Piano
16	Clav CB Flat
17	Clav CA Flat
18	Clav CB Medium
19	Clav CA Medium
20	Clav CB Brillia
21	Clav CA Brillia
22	Clav CB Combo
23	Clav CA Combo
24	TW Organ
25	Nylon Guitar
26	SteelStr Guitar
27	Acoustic Bass
28	Fingered Bass
29	Picked Bass
30	Strings
31	Marcato Strings

## SuperNATURAL Inst Parameters

### Ac. Piano

- 001 Concert Grand
- 002 Grand Piano1
- 003 Grand Piano2
- 004 Grand Piano3
- 005 Mellow Piano
- 006 Bright Piano
- 007 Upright Piano
- 008 Concert Mono
- 009 Honky-tonk

- Differences in your playing strength will smoothly change the tone character in a natural way.

Parameter	Value	Explanation
String Resonance	0–127	When the keys are pressed on an acoustic piano, the strings for keys that are already pressed also vibrate sympathetically. The function used to reproduce is called <b>“String Resonance.”</b> Increasing the value will increase the amount of effect.
Key Off Resonance	0–127	This adjusts resonances such as the key-off sound of an acoustic piano (subtle sounds that are heard when you release a key). Higher values will increase the volume of the resonances.
Hammer Noise	-2, -1, 0, +1, +2	This adjusts the sound of the hammer striking the string of an acoustic piano. Higher values will increase the sound of the hammer striking the string.
StereoWidth	0–63	The higher the value set, the wider the sound is spread out.
Nuance	Type1, Type2, Type3	This changes the Tone’s subtle nuances by altering the phase of the left and right sounds. This effect is difficult to hear when headphones are used. * This has no effect for 008:Concert Mono.
Tone Character	-5, -4, -3, -2, -1, 0, +1, +2, +3, +4, +5	Higher values produce a harder sound; lower values produce a more mellow sound.

### E. Piano

- 010 Pure Vintage EP1
- 011 Pure Vintage EP2
- 012 Pure Wurly
- 013 Pure Vintage EP3
- 014 Old Hammer EP
- 015 Dyno Piano

- Differences in your playing strength will smoothly change the tone character in a natural way.
- A key-off noise typical of that instrument will be heard when you release the key (PureWurly is excepted).

Parameter	Value	Explanation
Noise Level (CC#16)	-64–+63	Adjusts the amount of hum noise and key-off noise. Higher settings will raise the volume.

## Other Keyboards

- 016 Clav CB Flat
- 017 Clav CA Flat
- 018 Clav CB Medium
- 019 Clav CA Medium
- 020 Clav CB Brillia
- 021 Clav CA Brillia
- 022 Clav CB Combo
- 023 Clav CA Combo

- Differences in your playing strength will smoothly change the tone character in a natural way.
- A key-off noise typical of that instrument will be heard when you release the key.

Parameter	Value	Explanation
Noise Level (CC#16)	-64→+63	Adjusts the amount of hum noise and key-off noise. Higher settings will raise the volume.

## Organ

### 024 TW Organ

- The sound will be unaffected by the strength with which you play the keyboard.
- This allows you to use the nine harmonic bars to create your sound just as on a tone wheel organ.

Parameter	Value	Explanation
Harmonic Bar 16'	0–8	Adjust the level of each footage. A different harmonic component is assigned to each footage; the sound of the organ is created by mixing these components. The 8' footage is the core of the sound; this is the basic pitch around which the sound is created. * Harmonic Bar 1' is unavailable if Percussion Switch is on.
Harmonic Bar 5-1/3'	0–8	
Harmonic Bar 8'	0–8	
Harmonic Bar 4'	0–8	
Harmonic Bar 2-2/3'	0–8	
Harmonic Bar 2'	0–8	
Harmonic Bar 1-3/5'	0–8	
Harmonic Bar 1-1/3'	0–8	
Harmonic Bar 1'	0–8	
Leakage Level	0–127	Noise Level at which the signal of tone wheels unrelated to the pressed keys is mixed into the input
Percussion Switch	OFF, ON	If this is on, a crisp attack will be added to the beginning of the notes.
Percussion Soft	NORM, SOFT	<b>NORM:</b> The percussion sound will be at the normal volume, and the sound of the harmonic bars will be reduced. <b>SOFT:</b> The percussion sound will be reduced, and the harmonic bars will be at the normal volume.
Percussion Soft Level	0–15	Volume of the percussion sound when Percussion Soft is set to SOFT
Percussion Normal Level	0–15	Volume of the percussion sound when Percussion Soft is set to NORM
Percussion Slow	FAST, SLOW	<b>FAST:</b> The percussion sound will disappear immediately, producing a sharp attack. <b>SLOW:</b> The percussion sound will disappear slowly, producing a more gentle attack.
Percussion Slow Time	0–127	Decay time of the percussion sound when Percussion Slow is set to SLOW
Percussion Fast Time	0–127	Decay time of the percussion sound when Percussion Slow is set to FAST
Percussion Harmonic	2ND, 3RD	<b>2ND:</b> The percussion sound will be the same pitch as the 4' harmonic bar. <b>3RD:</b> The percussion sound will be the same pitch as the 2-2/3' harmonic bar.
Percussion Recharge Time	0–15	Normally, the percussion sound will be added only to the first note of successive notes played legato. This reproduces the characteristics of the analog circuitry that produced the percussion sound in tone wheel organs, which caused the percussion sound to be softer when keys were pressed in quick succession. This specifies the characteristics of this analog circuit.
Percussion Harmonic Bar Level	0–127	The volume of the organ will be reduced if Percussion Soft is set to NORM. This specifies how much the volume will be reduced.
Key On Click Level	0–31	Level of the key-click when a key is pressed
Key Off Click Level	0–31	Level of the key-click when a key is released

# SuperNATURAL Acoustic Tone (SN-A)

## Ac. Guitar

### 025 Nylon Guitar

### 026 SteelStr Guitar

- Rapid legato playing in an interval of two semitones or less will produce either a slide or a hammering-on effect, depending on how fast you play.
- If Strum Mode is off, playing an arpeggio with the Hold pedal held down will produce an arpeggio effect typical of a guitar.
- If Strum Mode is on, playing a chord with the Hold pedal held down will produce a guitar-like chordal performance.
- Note numbers 34 and lower can produce ghost notes as played on a guitar.

Parameter	Value	Explanation
Noise Level (CC#16)	-64–+63	Adjusts the volume of the string grazing or picking noise.
Strum Speed (CC#17)	-64–+63	Adjusts the deviation in the timing of sound production by the strings when strumming with Strum Mode turned on. Higher values produce a greater time deviation. The effect will be more significant for lower velocities.
Strum Mode (CC#19)	OFF, ON	If Strum Mode is turned on, strumming will be produced when you play multiple keys simultaneously. This also reproduces the difference in time at which each string of a guitar is sounded. The guitar's up strokes and down strokes will alternately be produced when chords are played in succession. It is effective to play while holding down the Hold pedal.
Variation	Refer to p. 29.	Performance variation sounds

## Ac. Bass

### 027 Acoustic Bass

- Rapid legato playing in an interval of two semitones or less will produce either a slide or a hammering-on effect, depending on how fast you play.

Parameter	Value	Explanation
Noise Level (CC#16)	-64–+63	Adjusts the volume of the string grazing or picking noise.
Variation	Refer to p. 29.	Performance variation sounds

## E. Bass

### 028 Fingered Bass

### 029 Picked Bass

- Rapid legato playing in an interval of two semitones or less will produce either a slide or a hammering-on effect, depending on how fast you play.

Parameter	Value	Explanation
Noise Level (CC#16)	-64–+63	Adjusts the volume of the string grazing or picking noise.
Variation	Refer to p. 29.	Performance variation sounds

## Strings

### 030 Strings

### 031 Marcato Strings

- The attack and release will be adjusted appropriately for the speed at which you play the phrase.  
For example, notes will sound more crisply for rapidly played passages.

Parameter	Value	Explanation
Hold Legato Mode (CC#19)	OFF, ON	Specifies how notes are sounded when Hold (CC64) is on. If Hold Legato Mode is on, notes that were being held will go silent when you play a key. For example if you play and release C major with Hold (CC64) on, the C major notes will be held. When you then play E major, the C major notes will go silent, and the E major notes will be heard.
Variation	Refer to p. 29.	Performance variation sounds

## Performance Variation Sounds

Inst		Variation			
No.	Name	1	2	3	4
1	Concert Grand	-	-	-	-
2	Grand Piano1	-	-	-	-
3	Grand Piano2	-	-	-	-
4	Grand Piano3	-	-	-	-
5	Mellow Piano	-	-	-	-
6	Bright Piano	-	-	-	-
7	Upright Piano	-	-	-	-
8	Concert Mono	-	-	-	-
9	Honky-tonk	-	-	-	-
10	Pure Vintage EP1	-	-	-	-
11	Pure Vintage EP2	-	-	-	-
12	Pure Wurly	-	-	-	-
13	Pure Vintage EP3	-	-	-	-
14	Old Hammer EP	-	-	-	-
15	Dyno Piano	-	-	-	-
16	Clav CB Flat	-	-	-	-
17	Clav CA Flat	-	-	-	-
18	Clav CB Medium	-	-	-	-
19	Clav CA Medium	-	-	-	-
20	Clav CB Brillia	-	-	-	-
21	Clav CA Brillia	-	-	-	-
22	Clav CB Combo	-	-	-	-
23	Clav CA Combo	-	-	-	-
24	TW Organ	-	-	-	-
25	Nylon Guitar	Mute	Harmonics	-	-
26	SteelStr Guitar	Mute	Harmonics	-	-
27	Acoustic Bass	Staccato	Harmonics	-	-
28	Fingered Bass	Slap	Harmonics	-	-
29	Picked Bass	Bridge Mute	Harmonics	-	-
30	Strings	Staccato	Pizzicato	Tremolo	-
31	Marcato Strings	Staccato	Pizzicato	Tremolo	-

## SuperNATURAL Acoustic Tone (SN-A)

Parameter	Value	Explanation
-----------	-------	-------------

### MFX tab

MFX Sw ( <b>[2]</b> (MFX Sw) button)	OFF, ON	Specifies whether the tone's multi-effect is used (ON) or not used (OFF).
MFX Type	0–68	Use this parameter to select from among the 68 available multi-effects. For details on multi-effects parameters, refer to <b>"MFX Parameters"</b> (p. 93).
Parameters for each MFX type	Edit the parameters for the selected MFX type.	
MFX Chorus Send Level	0–127	Adjusts the amount of chorus for the sound that passes through multi-effects. If you don't want to add the chorus effect, set it to <b>"0."</b>
MFX Reverb Send Level	0–127	Adjusts the amount of reverb for the sound that passes through multi-effects. If you don't want to add the reverb effect, set it to <b>"0."</b>

### MFX Control tab

Source (1–4)	OFF, CC01–31, 33–95, PITCH BEND, AFTERTOUCHE, SYS CTRL1–4	Sets the MIDI message used to change the multi-effects parameter with the multi-effects control. <b>OFF:</b> Multi-effects control will not be used. <b>CC01–31, 33–95:</b> Control Change <b>PITCH BEND:</b> Pitch Bend <b>AFTERTOUCHE:</b> Aftertouch <b>SYS CTRL1–4:</b> MIDI messages used as common multi-effects controls.
Destination (1–4)	Sets the multi-effects parameters to be controlled with the multi-effects control. The multi-effects parameters available for control will depend on the multi-effects type. For details, refer to <b>"Controlling a MFX via MIDI (MFX CONTROL)"</b> (p. 117).	
Sens (1–4)	-63–+63	Sets the amount of the multi-effects control's effect that is applied. To make an increase in the currently selected value (to get higher values, move to the right, increase rates, and so on), select a positive (+) value; to make a decrease in the currently selected value (to get lower values, move to the left, decrease rates, and so on), select a negative (-) value. For either positive or negative value, greater absolute values will allow greater amounts of change. Set this to <b>"0"</b> if you don't want to apply the effect.

# SuperNATURAL Synth Tone (SN-S)

## TONE EDIT (SN-S)

Each tone has three sets (Partial 1–3) of OSC, FILTER, AMP, and LFO settings, in addition to multi-effect (MFX) settings.

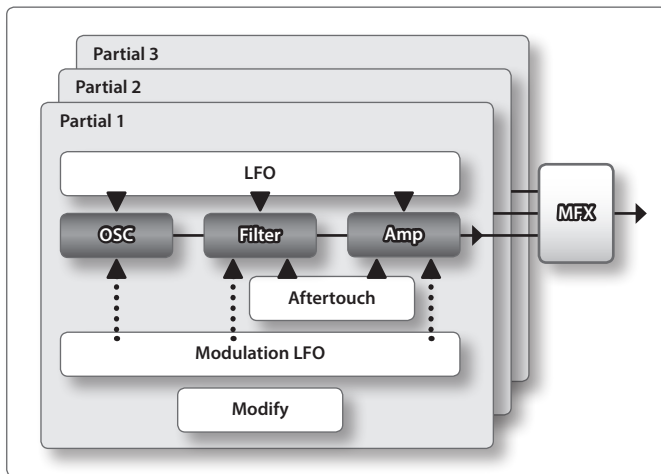

1. Select the part to which the tone is assigned.
2. Press the **[MENU]** button.
3. Move the cursor to **"Tone Edit"** and press the **[ENTER]** button.

Parameter	Value	Explanation
-----------	-------	-------------

### Common tab

\*1: Shown only if you press the **[4]** (Pro Edit) button to enter pro edit mode.

Tone Category *1	No Assign, Ac.Piano, Pop Piano, E.GrandPiano, E.Piano1, E.Piano2, E.Organ, Pipe Organ, Reed Organ, Harpsichord, Clav, Celesta, Accordion, Harmonica, Bell, Mallet, Ac.Guitar, E.Guitar, Dist.Guitar, Ac.Bass, E.Bass, Synth Bass, Plucked/Stroke, Solo Strings, Ens.Strings, Orhestral, Solo Brass, Ens.Brass, Wind, Flute, Sax, Recorder, Vox/Choir, Scat, Synth Lead, Synth Brass, Synth Pad/Str, Synth Bellpad, Synth PolyKey, Synth FX, Synth Seq/Pop, Phrase, Pulsating, Beat&Groove, Hit, Sound FX, Drums, Percussion, Stack, Zone	Selects the tone's category.
Phrase Number	0–243	Number of the phrase that plays when you press the <b>[PREVIEW]</b> button.
Phrase Octave Shift	-3+3	Pitch (in octave units) of the preview phrase.
Tone Level	0–127	Adjusts the overall volume of the tone.

## SuperNATURAL Synth Tone (SN-S)





Parameter	Value	Explanation										
RING Switch *1	OFF, ON	<p>Turns ring modulator on/off.</p> <p>By multiplying partial 1's OSC and partial 2's OSC, this creates a complex, metallic-sounding waveform like that of a bell.</p> <p>The partial 1's OSC waveform will change as shown in the illustration, and partial 2's OSC will be output with its original waveform.</p> <p>Setting the partial 1 OSC and the partial 2 OSC to different pitches will make the ring modulator effect more apparent.</p> <p>If Ring Switch is turned on, the OSC Pulse Width Mod Depth, OSC Pulse Width, and SUPER SAW Detune of partial 1 and partial 2 cannot be used.</p> <p>In addition, if an asymmetrical square wave is selected as the OSC waveform, the OSC variation will be ignored, and there will be a slight difference in sound compared to the originally selected waveform.</p>										
Wave Shape	0-127	<p>Partial 1 will be modulated by the pitch of partial 2. Higher values produce a greater effect.</p> <p>This has no effect if the partial 1 waveform is PW-SQR or SP-SAW.</p>										
Analog Feel *1	0-127	<p>Use this to apply "<b>1/f fluctuation</b>," a type of randomness or instability that is present in many natural systems (such as a babbling brook or whispering breeze) and is perceived as pleasant by many people.</p> <p>By applying "<b>1/f fluctuation</b>" you can create the natural-sounding instability that is characteristic of an analog synthesizer.</p>										
Unison Switch	OFF, ON	<p>This layers a single sound.</p> <p>If the Unison Switch is on, the number of notes layered on one key will change according to the number of keys you play.</p>										
Unison Size	2, 4, 6, 8	<p>Number of notes assigned to each key when the Unison Switch is on</p> <p>Example: If Unison Size is 8</p> <table border="1"> <thead> <tr> <th>Number of keys pressed</th> <th>Number of notes sounded</th> </tr> </thead> <tbody> <tr> <td>1</td> <td>8</td> </tr> <tr> <td>2</td> <td>4 each</td> </tr> <tr> <td>3-4</td> <td>2 each</td> </tr> <tr> <td>5-8</td> <td>1 each</td> </tr> </tbody> </table>	Number of keys pressed	Number of notes sounded	1	8	2	4 each	3-4	2 each	5-8	1 each
Number of keys pressed	Number of notes sounded											
1	8											
2	4 each											
3-4	2 each											
5-8	1 each											
Mono/Poly	POLY, MONO	<p>Specifies whether notes will sound polyphonically (POLY) or monophonically (MONO).</p>										
Legato Switch *1	OFF, ON	<p>This is valid only if the Mono/Poly parameter is set to "<b>MONO</b>." If this is on, pressing a key while the previous key remains held down will cause the pitch to change to that of the newly pressed key while maintaining the state in which the previous note was being sounded.</p> <p>This produces an effect similar to hammering-on or pulling-off when playing a guitar.</p>										
Portamento Switch	OFF, ON	<p>Specifies whether the portamento effect will be applied (ON) or not applied (OFF).</p>										
Portamento Time	0-127	<p>Specifies the time taken for the pitch to change when playing portamento.</p> <p>Higher values lengthen the time over which the pitch will change to the next note.</p>										
Portamento Mode *1	NORMAL, LEGATO	<p><b>NORMAL:</b> Portamento will always be applied.</p> <p><b>LEGATO:</b> Portamento will be applied only when you play legato (i.e., when you press the next key before releasing the previous key).</p>										
Bend Mode *1	NORMAL, CATCH+LAST	<p><b>NORMAL:</b> The pitch bend lever works in the conventional way.</p> <p><b>CATCH+LAST:</b> The pitch lever affects only the last-sounded note. If you play a note while the pitch bend lever is already moved, that note sounds at its normal pitch (as though the lever were in the center).</p> <p>The pitch starts changing only after the lever passes through the center position.</p>										



Parameter	Value	Explanation
-----------	-------	-------------

## OSC tab

\*1: Shown only if you press the [4] (Pro Edit) button to enter pro edit mode.

Partial Switch *1	OFF, ON	Use these buttons to turn the partials on/off.
Wave	SAW 	This waveform contains a sine wave fundamental plus a fixed proportion of sine wave harmonics at all integer multiples of that fundamental.
	SQR 	This waveform contains a sine wave fundamental plus a fixed proportion of sine wave harmonics at odd-numbered multiples of that fundamental.
	PW-SQR 	The overtone structure of this waveform will vary significantly depending on the width of the upper portion of the waveform (Pulse Width).
	TRI 	This waveform contains a sine wave fundamental plus a fixed proportion of sine wave harmonics at even-numbered multiples of that fundamental.
	SINE 	This is a sine wave. This is a waveform that produces just a single frequency; it is the basis of all sound.
	NOISE	This waveform contains all frequencies. It is suitable for percussion instrument sounds or sound effects.
	SUPER SAW (SP-SAW)	This produces a tone similar to seven sawtooth waves heard simultaneously. Pitch-shifted sounds are added to the center sound. It is suitable for strings sounds, and for creating thick sounds.
	PCM	This is a PCM waveform.
Wave Variation	A, B, C	You can select variations of the currently selected WAVE. * This has no effect for SP-SAW or PCM.
Wave Number	1–450	Selects the PCM waveform. * This is valid only if PCM is selected for OSC Wave.
Wave Gain *1	-6, 0, +6, +12 dB	Specifies the gain (amplitude) of the waveform. The value will change in 6 dB (decibel) steps. Each 6 dB increase doubles the gain. * This is valid only if PCM is selected for OSC Wave.
Pulse Width Mod Depth *1	0–127	Specifies the amount (depth) of LFO applied to PW (Pulse Width). If the OSC Wave has selected (PW-SQR), you can use this slider to specify the amount of LFO modulation applied to PW (pulse width). * If the Ring Switch is on, this has no effect on partials 1 and 2.
Pulse Width *1	0–127	Specifies the pulse width. If the OSC Wave has selected (PW-SQR), you can use this slider to specify the width of the upper portion of the square wave (the pulse width) as a percentage of the entire cycle. Decreasing the value will decrease the width, approaching a square wave (pulse width = 50 %). Increasing the value will increase the width, producing a distinctive sound. * If the Ring Switch is on, this has no effect on partials 1 and 2.
Pulse Width Shift *1	0–127	Shifts the range of change. Normally, you can leave this at 127. * If the Ring Switch is on, this has no effect on partials 1 and 2.
Super Saw Detune	0–127	Specifies the amount of pitch difference between the seven sawtooth waves layered within a single oscillator. * Higher values will increase the pitch difference (OSC Detune applies an equal amount of pitch difference between each of the seven sawtooth waves). * If the Ring Switch is on, this has no effect on partials 1 and 2. * This is valid only if SP-SAW is selected for OSC Wave.

## Pitch tab

\*1: Shown only if you press the [4] (Pro Edit) button to enter pro edit mode.

OSC Pitch (Pitch)	-24–+24	Adjusts the pitch in semitone steps.
OSC Detune (Detune)	-50–+50	Adjusts the pitch in steps of one cent.
Pitch Env Attack Time (A)	0–127	Specifies the attack time of the pitch envelope. This specifies the time from the moment you press the key until the pitch reaches its highest (or lowest) point.
Pitch Env Decay Time (D)	0–127	Specifies the decay time of the pitch envelope. This specifies the time from the moment the pitch reaches its highest (or lowest) point until it returns to the pitch of the key you pressed.
Pitch Env Depth (Env Depth)	-63–+63	This specifies how much the pitch envelope will affect the pitch.
Octave Shift *1	-3–+3	Specifies the octave of the tone.
Pitch Bend Range Up *1	0–+24	Specifies the amount of pitch change that occurs when the pitch bend/modulation lever is moved all the way to the right.
Pitch Bend Range Down *1	0–-24	Specifies the amount of pitch change that occurs when the pitch bend/modulation lever is moved all the way to the left.

# SuperNATURAL Synth Tone (SN-S)

Parameter	Value	Explanation
-----------	-------	-------------

## Filter tab

\*1: Shown only if you press the [4] (Pro Edit) button to enter pro edit mode.

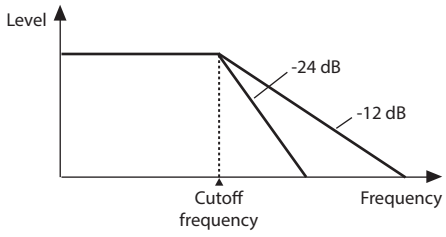
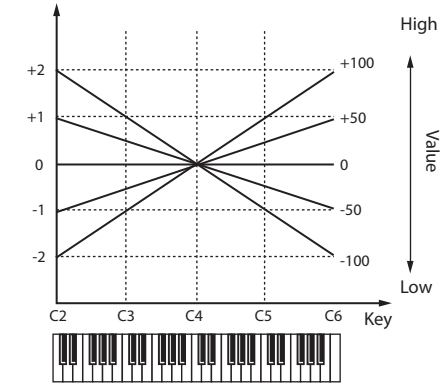
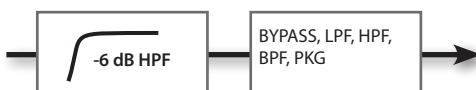
FILTER Mode (Mode)	BYPASS, LPF1, LPF2, LPF3, LPF4, HPF, BPF, PKG	Selects the type of filter.
FILTER Slope (Slope)	-12, -24 dB	<p>This button selects the slope (steepness) of the filter.</p> <p>For the LPF</p> 
FILTER Cutoff (Cutoff)	0-127	Specifies the cutoff frequency.
FILTER Cutoff KF (KeyFollow)	-100-+100	<p>Here's how you can make the filter cutoff frequency to vary according to the key you play.</p> <p>Cutoff frequency (octave)</p> 
FILTER Env V-Sens *1	-63-+63	Here's how you can make the filter envelope depth vary according to the strength with which you play the key.
FILTER Resonance (Resonance)	0-127	Resonance emphasizes the sound in the region of the filter cutoff frequency.
FILTER Env Attack (A)	0-127	This specifies the time from the moment you press the key until the cutoff frequency reaches its highest (or lowest) point.
FILTER Env Decay (D)	0-127	This specifies the time from when the cutoff frequency reaches its highest (or lowest) point, until it decays to the sustain level.
FILTER Env Sustain (S)	0-127	This specifies the cutoff frequency that will be maintained from when the decay time has elapsed until you release the key.
FILTER Env Release (R)	0-127	This specifies the time from when you release the key until the cutoff frequency reaches its minimum value.
FILTER Env Depth (Env Depth)	-63-+63	This specifies the direction and depth to which the cutoff frequency will change.
HPF Cutoff *1	0-127	<p>Specifies the cutoff frequency of an independent -6 dB high-pass filter.</p> 

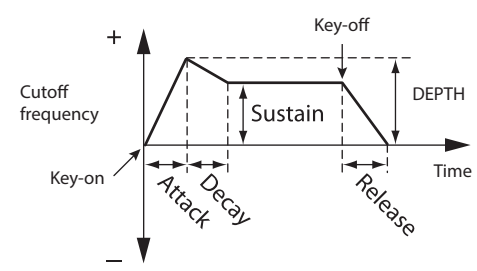

Parameter	Value	Explanation
-----------	-------	-------------



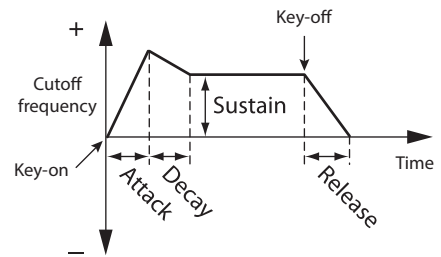

### Amp tab

\*1: Shown only if you press the [4] (Pro Edit) button to enter pro edit mode.

AMP Level (Level)	0-127	Partial volume.
AMP Level V-Sens (Velo Sens)	-63--+63	Here's how you can make the volume vary according to the strength with which you play the keyboard.
AMP Pan (Pan)	L64-63R	Here's how to change the stereo position of the partial.
AMP Level Keyfollow *1	-100, -90, -80, -70, -60, -50, -40, -30, -20, -10, 0, +10, +20, +30, +40, +50, +60, +70, +80, +90, +100	Specify this if you want to vary the volume according to the position of the key that you play. With the C4 key (middle C) as the base volume, "+" values will make the volume increase as you play above C4; "-" values will make the volume decrease. Higher values will produce greater change.
AMP Env Attack (A)	0-127	Specifies the attack time of the amp envelope. This specifies the time from the moment you press the key until the maximum volume is reached.
AMP Env Decay (D)	0-127	Specifies the decay time of the amp envelope. This specifies the time from when the maximum volume is reached, until it decays to the sustain level.
AMP Env Sustain (S)	0-127	Specifies the sustain level of the amp envelope. This specifies the volume level that will be maintained from when the attack and decay times have elapsed until you release the key.
AMP Env Release (R)	0-127	Specifies the release time of the amp envelope. This specifies the time from when you release the key until the volume reaches its minimum value.



### LFO tab

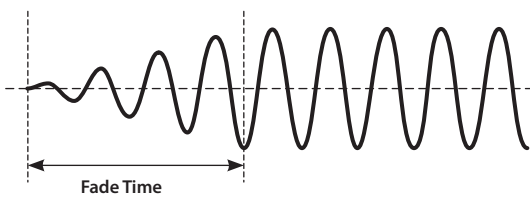



LFO Shape (Shape)	Selects the LFO waveform.	
	TRI 	Triangle wave
	SIN 	Sine wave
	SAW 	Sawtooth wave
	SQR 	Square wave
	S&H	Sample and Hold (The LFO value will change once each cycle.)
	RND	Random wave
LFO Rate (Rate)	0-127	Specifies the LFO rate when Modulation LFO Tempo Sync Switch is OFF.
LFO Tempo Sync Sw (Tempo Sync Switch)	OFF, ON	If this is ON, the LFO rate can be specified as a note value relative to the tempo.
LFO Tempo Sync Note (Rate)	16, 12, 8, 4, 2, 1, 3/4, 2/3, 1/2, 3/8, 1/3, 1/4, 3/16, 1/6, 1/8, 3/32, 1/12, 1/16, 1/24, 1/32	Specifies the LFO rate when Modulation LFO Tempo Sync Switch is ON.
LFO Fade Time (Fade Time)	0-127	This specifies the time from when the partial sounds until the LFO reaches its maximum amplitude. 
LFO Key Trigger (Key Trigger)	OFF, ON	If this is on, the LFO cycle will be restarted when you press a key.
LFO Pitch Depth (Pitch Depth)	-63--+63	This allows the LFO to modulate the pitch, producing a vibrato effect.
LFO FILTER Depth (Filter Depth)	-63--+63	This allows the LFO to modulate the FILTER CUTOFF (cutoff frequency), producing a wah effect.
LFO AMP Depth (Amp Depth)	-63--+63	This allows the LFO to modulate the AMP LEVEL (volume), producing a tremolo effect.
LFO Pan Depth (Pan Depth)	-63--+63	This allows the LFO to make the PAN (stereo position) vary (Auto Panning).

# SuperNATURAL Synth Tone (SN-S)

Parameter	Value	Explanation
-----------	-------	-------------

## Modulation LFO tab

\*1: Shown only if you press the [4] (Pro Edit) button to enter pro edit mode.

Modulation LFO Shape (Shape)	Selects the Modulation LFO waveform. In addition to the LFO that is always applied to the partial, there is a Modulation LFO that is controlled by the modulation controller (CC01).	
	TRI 	Triangle wave
	SIN 	Sine wave
	SAW 	Sawtooth wave
	SQR 	Square wave
	S&H	Sample and Hold (The LFO value will change once each cycle.)
	RND	Random wave
Modulation LFO Rate (Rate)	0-127	Specifies the LFO rate when Modulation LFO Tempo Sync Switch is OFF.
Modulation LFO Tempo Sync Sw (Tempo Sync Switch)	OFF, ON	If this is ON, the LFO rate can be specified as a note value relative to the tempo.
Modulation LFO Tempo Sync Note (Rate)	16, 12, 8, 4, 2, 1, 3/4, 2/3, 1/2, 3/8, 1/3, 1/4, 3/16, 1/6, 1/8, 3/32, 1/12, 1/16, 1/24, 1/32	Specifies the LFO rate when Modulation LFO Tempo Sync Switch is ON.
Modulation LFO Pitch Depth (Pitch Depth)	-63+63	This allows the LFO to modulate the pitch, producing a vibrato effect.
Modulation LFO FILTER Depth (Filter Depth)	-63+63	This allows the LFO to modulate the FILTER CUTOFF (cutoff frequency), producing a wah effect.
Modulation LFO AMP Depth (Amp Depth)	-63+63	This allows the LFO to modulate the AMP LEVEL (volume), producing a tremolo effect.
Modulation LFO Pan Depth (Pan Depth)	-63+63	This allows the LFO to make the PAN (stereo position) vary (Auto Panning).
Modulation LFO Rate Control *1	-63+63	This specifies how the modulation controller (CC01) will change the Modulation LFO Rate. Specify a positive (+) value if you want the Modulation LFO rate to become faster when you raise the modulation controller (CC01) value; specify a negative (-) value if you want the rate to become slower.

## Aftertouch tab

Cutoff Aftertouch Sens (Cutoff Sens)	-63+63	Specifies how aftertouch pressure will affect the cutoff frequency. Specify a positive (+) value if you want aftertouch to raise the cutoff frequency; specify a negative (-) value if you want aftertouch to lower the cutoff frequency.
Level Aftertouch Sens (Level Sens)	-63+63	Specifies how aftertouch pressure will affect the volume. Specify a positive (+) value if you want aftertouch to increase the volume; specify a negative (-) value if you want aftertouch to decrease the volume.

## Misc tab

\*1: Shown only if you press the [4] (Pro Edit) button to enter pro edit mode.

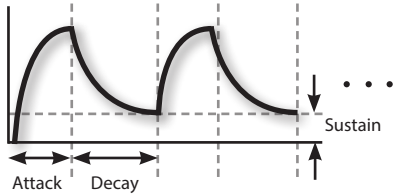
Attack Time Interval Sens (Attack Time)	0-127	Shortens the FILTER and AMP Attack Time according to the spacing between note-on events. Higher values produce a greater effect. With a setting of 0, there will be no effect. This is effective when you want to play rapid notes using a sound that has a slow attack (Attack Time).
Release Time Interval Sens (Release Tim)	0-127	Shortens the FILTER and AMP Release Time if the interval between one note-on and the next note-off is brief. Higher values produce a greater effect. With a setting of 0, there will be no effect. This is effective when you want to play staccato notes using a sound that has a slow release.
Portamento Time Interval Sens (Portamento Time)	0-127	Shortens the Portamento Time according to the spacing between note-on events. Higher values produce a greater effect. With a setting of 0, there will be no effect.
Envelope Loop Mode *1	Use this to loop the envelope between certain regions during a note-on. 	
	OFF	The envelope will operate normally.
	FREE-RUN	When the Decay segment has ended, the envelope will return to the Attack. The Attack through Decay segments will repeat until note-off occurs.
	TEMPO-SYNC	Specifies the loop rate as a note value (Envelope Loop Sync Note parameter).

Parameter	Value	Explanation
Envelope Loop Sync Note *1	Note (p. 116)	Returns to the Attack at the specified rate. If the Attack+Decay time is shorter than the specified rate, the Sustain Level will be maintained. If the Attack+Decay time is longer than the specified rate, the envelope will return to the Attack even though the Decay has not been completed. This will continue repeating until note-off occurs.
Chromatic Portamento *1	OFF, ON	If this is turned on, portamento will operate in semitone steps.

## MFX tab

MFX Sw ([2] (MFX Sw) button)	OFF, ON	Specifies whether the tone's multi-effect is used (ON) or not used (OFF).
MFX Type	0-68	Use this parameter to select from among the 68 available multi-effects. For details on multi-effects parameters, refer to "MFX Parameters" (p. 93).
Parameters for each MFX type	Edit the parameters for the selected MFX type.	
MFX Chorus Send Level	0-127	Adjusts the amount of chorus for the sound that passes through multi-effects. If you don't want to add the chorus effect, set it to "0."
MFX Reverb Send Level	0-127	Adjusts the amount of reverb for the sound that passes through multi-effects. If you don't want to add the reverb effect, set it to "0."

## MFX Control tab

Source (1-4)	OFF, CC01-31, 33-95, PITCH BEND, AFTERTOUCHE, SYS CTRL1-4	Sets the MIDI message used to change the multi-effects parameter with the multi-effects control. <b>OFF:</b> Multi-effects control will not be used. <b>CC01-31, 33-95:</b> Control Change <b>PITCH BEND:</b> Pitch Bend <b>AFTERTOUCHE:</b> Aftertouch <b>SYS CTRL1-4:</b> MIDI messages used as common multi-effects controls.
Destination (1-4)	Sets the multi-effects parameters to be controlled with the multi-effects control. The multi-effects parameters available for control will depend on the multi-effects type. For details, refer to "Controlling a MFX via MIDI (MFX CONTROL)" (p. 117).	
Sens (1-4)	-63-+63	Sets the amount of the multi-effects control's effect that is applied. To make an increase in the currently selected value (to get higher values, move to the right, increase rates, and so on), select a positive (+) value; to make a decrease in the currently selected value (to get lower values, move to the left, decrease rates, and so on), select a negative (-) value. For either positive or negative value, greater absolute values will allow greater amounts of change. Set this to "0" if you don't want to apply the effect.

# SuperNATURAL Drum Kit (SN-D)

## TONE EDIT (SN-D)

Each kit has settings for 62 drum instruments, in addition to multi-effect (MFX) settings.

You can assign a different note number that will sound each of the 62 partials.

For the one part specified by the Drum Comp+EQ Assign setting, you'll be able to use six sets of compressor + equalizer units to make the sound more consistent or to adjust the tonal character.

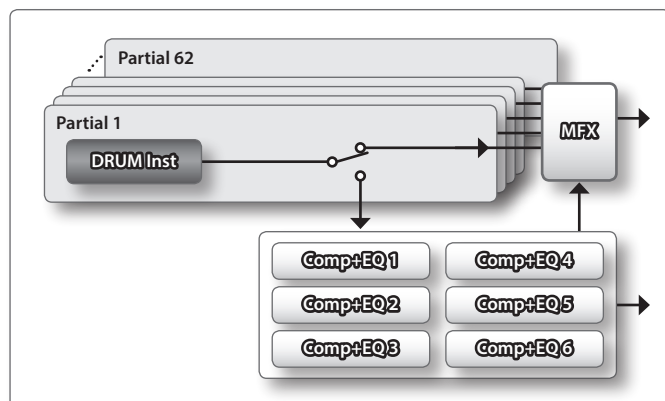

1. Select the part to which the tone is assigned.
2. Press the [MENU] button.
3. Move the cursor to "Tone Edit" and press the [ENTER] button.

Parameter	Value	Explanation
-----------	-------	-------------

### Common tab

Phrase Number	0–16	Number of the phrase that plays when you press the [PREVIEW] button.
Drum Kit Level	0–127	Sets the volume of the entire drum kit.
Ambience Level	0–127	Specifies the volume of the drum kit resonances and the resonances of the room. This applies only for sounds whose type is Kick, Snare, Tom, and Hi-Hat. * For some drum instruments, this will have no effect. Refer to "SuperNATURAL Drum Inst List" (p. 40).

### DRUM Inst tab

#### MEMO

CURRENT PARTIAL (the currently selected partial) specifies the note number (27 (Eb1)–88 (E6)) to which you will assign a drum instrument.

Inst Number	000: OFF, 001–	Selects the drum inst number assigned to partial.
Tune	-120→+120	Adjusts the pitch of the drum inst.
Attack	0–100 %	Adjusts the level and time of the attack. A setting of 100 % produces the fastest attack.
Decay	-63–0	Adjusts the decay time. Negative (-) value will produce a muting effect.
Level	0–127	Sets the volume of the drum inst.
Pan	L64–63R	Sets the pan of the drum inst.
Chorus Send Level	0–127	Specifies the level of the signal sent to the chorus for each drum inst.
Reverb Send Level	0–127	Specifies the level of the signal sent to the reverb for each drum inst.
Brilliance	-15→+12	Adjusts the brilliance of the sound. Positive (+) value make the sound brighter, and negative (-) value make the sound darker.
Variation	OFF, FLAM1, FLAM2, FLAM3, BUZZ1, BUZZ2, BUZZ3, ROLL	Specifies performance variations such as flam, buzz, or roll. * The parameters available for editing will depend on the drum instrument. Refer to "SuperNATURAL Drum Inst List" (p. 40).
Dynamic Range	0–63	Specifies the curve by which velocity will affect the volume. With a setting of 0, any velocity will produce the maximum volume.
Stereo Width	0–127	Adjusts the stereo width of the sound. A setting of 0 is mono. * For some drum instruments, this will have no effect. Refer to "SuperNATURAL Drum Inst List" (p. 40).
Output Assign	PART, COMP+EQ1–6	Specifies for each drum inst how the sound will be output.

Parameter	Value	Explanation
-----------	-------	-------------

## Comp tab

\* COMP + EQ can be used only for the part specified by the Drum Comp+EQ Assign setting.

Comp 1–6 Switch	OFF, ON	Compressor on/off setting
Comp 1–6 Attack Time	0.05–50.0 ms	Time from when the input exceeds the threshold until compression begins
Comp 1–6 Release Time	0.05–2000 ms	Time from when the input falls below the threshold until compression is turned off
Comp 1–6 Threshold	0–127	Level above which compression is applied
Comp 1–6 Ratio	1:1–inf:1	Compression ratio
Comp 1–6 Output Gain	0–+24 dB	Level of the output sound

## EQ tab

\* COMP + EQ can be used only for the part specified by the Drum Comp+EQ Assign setting.

EQ 1–6 Switch	OFF, ON	Equalizer on/off setting
EQ1–6 Low Freq	200, 400 Hz	Frequency of the low range
EQ1–6 Low Gain	-15–+15 dB	Gain of the low frequency range
EQ1–6 Mid Freq	200, 250, 315, 400, 500, 630, 800, 1000, 1250, 1600, 2000, 2500, 3150, 4000, 5000, 6300, 8000 Hz	Frequency of the middle range
EQ1–6 Mid Gain	-15–+15 dB	Gain of the middle frequency range
EQ1–6 Mid Q	0.5, 1.0, 2.0, 4.0, 8.0	Width of the middle frequency range Set a higher value for Q to narrow the range to be affected.
EQ1–6 High Freq	2000, 4000, 8000 Hz	Frequency of the high range
EQ1–6 High Gain	-15–+15 dB	Gain of the high frequency range

## MFX tab

MFX Sw ( <b>[2]</b> (MFX Sw) button)	OFF, ON	Specifies whether the tone's multi-effect is used (ON) or not used (OFF).
MFX Type	0–68	Use this parameter to select from among the 68 available multi-effects. For details on multi-effects parameters, refer to " <b>MFX Parameters</b> " (p. 93).
Parameters for each MFX type	Make parameter settings for the selected MFX type.	
MFX Chorus Send Level	0–127	Adjusts the amount of chorus for the sound that passes through multi-effects. If you don't want to add the chorus effect, set it to " <b>0</b> ."
MFX Reverb Send Level	0–127	Adjusts the amount of reverb for the sound that passes through multi-effects. If you don't want to add the reverb effect, set it to " <b>0</b> ."

## MFX Control tab

Source (1–4)	OFF, CC01–31, 33–95, PITCH BEND, AFTERTOUCHE, SYS CTRL1–4	Sets the MIDI message used to change the multi-effects parameter with the multi-effects control. <b>OFF</b> : Multi-effects control will not be used. <b>CC01–31, 33–95</b> : Control Change <b>PITCH BEND</b> : Pitch Bend <b>AFTERTOUCHE</b> : Aftertouch <b>SYS CTRL1–4</b> : MIDI messages used as common multi-effects controls.
Destination (1–4)	Sets the multi-effects parameters to be controlled with the multi-effects control. The multi-effects parameters available for control will depend on the multi-effects type. For details, refer to " <b>Controlling a MFX via MIDI (MFX CONTROL)</b> " (p. 117).	
Sens (1–4)	-63–+63	Sets the amount of the multi-effects control's effect that is applied. To make an increase in the currently selected value (to get higher values, move to the right, increase rates, and so on), select a positive (+) value; to make a decrease in the currently selected value (to get lower values, move to the left, decrease rates, and so on), select a negative (-) value. For either positive or negative value, greater absolute values will allow greater amounts of change. Set this to " <b>0</b> " if you don't want to apply the effect.

## SuperNATURAL Drum Inst List

The following table shows support for the Ambience Level parameter of the Common tab and the Stereo Width parameter of the DRUM Inst tab. Variation indicates support for the performance variation in the DRUM Inst tab.

No.	Inst Name	Type	Stereo Width	Ambience Level	Variation
1	Studio Kick	Kick	✓	✓	Flam/Buzz
2	Studio Kick 2	Kick	✓	✓	Flam/Buzz
3	Studio Sn 2	Snare	✓	✓	Flam/Buzz/Roll
4	Studio Sn 2 Rim	Snare	✓	✓	Flam/Buzz/Roll
5	Studio Sn 2 XStk	Snare	✓	✓	Flam/Buzz
6	Rock Tom Hi	Tom	✓	✓	Flam/Buzz
7	Rock Tom Mid	Tom	✓	✓	Flam/Buzz
8	Rock Tom Floor	Tom	✓	✓	Flam/Buzz
9	Med HH Close	Hi-Hat	✓	✓	Flam/Buzz
10	Med HH Open	Hi-Hat	✓	✓	Flam/Buzz
11	Med HH Pedal	Hi-Hat	✓	✓	Flam/Buzz
12	Standard Rd Edge	Ride	✓	-	Flam/Buzz
13	Standard Rd Bell	Ride	✓	-	Flam/Buzz
14	Std Rd Edge/Bell	Ride	✓	-	Flam/Buzz
15	Flat 18"Ride	Ride	✓	-	Flam/Buzz
16	Standard 16"Cr R	Crash	✓	-	Flam/Buzz/Roll
17	Standard 16"Cr L	Crash	✓	-	Flam/Buzz/Roll
18	Jazz 16"Cr R	Crash	✓	-	Flam/Buzz/Roll
19	Jazz 16"Cr L	Crash	✓	-	Flam/Buzz/Roll
20	Splash Cymbal 2	Crash	✓	-	Flam/Buzz
21	China Cymbal	Crash	✓	-	Flam/Buzz
22	Tambourine 1	Percussion	✓	-	Flam/Buzz/Roll
23	Cowbell 1	Percussion	✓	-	Flam/Buzz
24	Vibra-slap	Percussion	-	-	Flam/Buzz
25	High Bongo 1	Percussion	✓	-	Flam/Buzz/Roll
26	Low Bongo 1	Percussion	✓	-	Flam/Buzz
27	MuteHi Conga 1	Percussion	✓	-	Flam/Buzz
28	OpenHi Conga 1	Percussion	✓	-	Flam/Buzz/Roll
29	Low Conga 1	Percussion	✓	-	Flam/Buzz/Roll
30	High Timbale	Percussion	✓	-	Flam/Buzz
31	Low Timbale	Percussion	✓	-	Flam/Buzz
32	High Agogo 1	Percussion	✓	-	Flam/Buzz
33	Low Agogo 1	Percussion	✓	-	Flam/Buzz
34	Cabasa 1	Percussion	✓	-	Flam/Buzz
35	Maracas 1	Percussion	✓	-	Flam/Buzz
36	Maracas 2	Percussion	-	-	Flam/Buzz
37	Short Whistle	Percussion	-	-	Flam/Buzz
38	Long Whistle	Percussion	-	-	Flam/Buzz
39	Short Guiro	Percussion	-	-	Flam/Buzz
40	Long Guiro	Percussion	-	-	Flam/Buzz
41	Claves 1	Percussion	✓	-	Flam/Buzz
42	Hi WoodBlock 1	Percussion	✓	-	Flam/Buzz
43	Low WoodBlock 1	Percussion	✓	-	Flam/Buzz
44	Mute Cuica 1	Percussion	✓	-	Flam/Buzz
45	Open Cuica 1	Percussion	✓	-	Flam/Buzz
46	Mute Triangle 1	Percussion	-	-	Flam/Buzz/Roll
47	Open Triangle 1	Percussion	-	-	Flam/Buzz/Roll
48	Shaker	Percussion	-	-	Flam/Buzz
49	Sleigh Bell 1	Percussion	✓	-	Flam/Buzz
50	Wind Chimes	Percussion	✓	-	Flam/Buzz



No.	Inst Name	Type	Stereo Width	Ambience Level	Variation
51	Castanets 1	Percussion	✓	-	Flam/Buzz/Roll
52	Mute Surdo 1	Percussion	✓	-	Flam/Buzz
53	Open Surdo 1	Percussion	✓	-	Flam/Buzz
54	Square Click	Other	-	-	Flam/Buzz
55	Metro Click	Other	-	-	Flam/Buzz
56	Metro Bell	Other	-	-	Flam/Buzz
57	High Q	SFX	-	-	Flam/Buzz
58	Slap	SFX	-	-	Flam/Buzz
59	Scratch Push	SFX	-	-	Flam/Buzz
60	Scratch Pull	SFX	-	-	Flam/Buzz
61	Applause	SFX	✓	-	-

# PCM Synth Tone (PCMS)

## TONE EDIT (PCMS)

Each tone has settings for four sets (Partial 1–4) of WAVE, TVF, TVA, and LFO x 2, in addition to multi-effect (MFX) settings.

You can create sounds by combining four partials.

Each partial can be turned on/off, allowing you to specify which partial (s) will be heard.

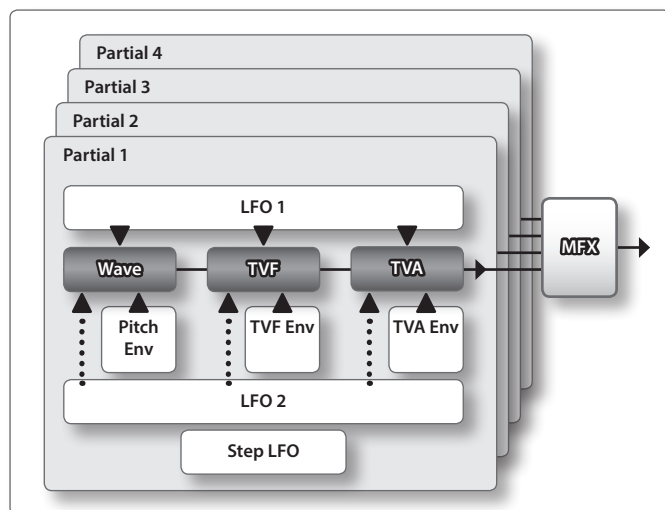

1. Select the part to which the tone is assigned.
2. Press the [MENU] button.
3. Move the cursor to “Tone Edit” and press the [ENTER] button.

### MEMO

In this manual, Parameters that can be controlled using the Matrix Control (p. 58) are marked with a “★.”

Parameter	Value	Explanation
-----------	-------	-------------

### Common tab

Tone Category	No Assign, Ac.Piano, Pop Piano, E.GrandPiano, E.Piano1, E.Piano2, E.Organ, Pipe Organ, Reed Organ, Harpsichord, Clav, Celesta, Accordion, Harmonica, Bell, Mallet, Ac.Guitar, E.Guitar, Dist.Guitar, Ac.Bass, E.Bass, Synth Bass, Plucked/Stroke, Solo Strings, Ens.Strings, Orhestral, Solo Brass, Ens.Brass, Wind, Flute, Sax, Recorder, Vox/Choir, Scat, Synth Lead, Synth Brass, Synth Pad/Str, Synth Bellpad, Synth PolyKey, Synth FX, Synth Seq/Pop, Phrase, Pulsating, Beat&Groove, Hit, Sound FX, Drums, Percussion, Stack, Zone	Selects the tone’s category.
Phrase Number	0–243	Number of the phrase that plays when you press the [PREVIEW] button.
Phrase Octave Shift	-3→+3	Pitch (in octave units) of the preview phrase.
Tone Level	0–127	Adjusts the overall volume of the tone.
Tone Pan	L64–63R	Specifies the pan of the tone. “L64” is far left, “0” is center, and “63R” is far right.
Tone Priority	LAST, LOUDEST	This determines how notes will be managed when the maximum polyphony is exceeded (128 voices). <b>LAST:</b> The last-played voices will be given priority, and currently sounding notes will be turned off in order, beginning with the first-played note. <b>LOUDEST:</b> The voices with the loudest volume will be given priority, and currently sounding notes will be turned off, beginning with the lowest-volume voice.
Octave Shift	-3→+3	Adjusts the pitch of the tone’s sound up or down in units of an octave (+/-3 octaves).
Tone Coarse Tune	-48→+48	Adjusts the pitch of the tone’s sound up or down in semitone steps (+/-4 octaves).
Tone Fine Tune	-50→+50	Adjusts the pitch of the tone’s sound up or down in 1-cent steps (+/-50 cents). * One cent is 1/100th of a semitone.

Parameter	Value	Explanation
Stretch Tune Depth	OFF, 1-3	<p>This setting allows you to apply “<b>stretched tuning</b>” to the tone (Stretched tuning is a system by which acoustic pianos are normally tuned, causing the lower range to be lower and the higher range to be higher than the mathematical tuning ratios would otherwise dictate.). With a setting of “<b>OFF</b>,” the tone’s tuning will be equal temperament. A setting of “<b>3</b>” will produce the greatest difference in the pitch of the low and high ranges.</p> <p>The diagram shows the pitch change relative to equal temperament that will occur in the low and high ranges. This setting will have a subtle effect on the way in which chords resonate.</p>
Analog Feel	0-127	<p>Specifies the depth of 1/f modulation that is to be applied to the tone (1/f modulation is a pleasant and naturally-occurring ratio of modulation that occurs in a babbling brook or rustling wind).</p> <p>By adding this “<b>1/f modulation</b>,” you can simulate the natural instability characteristic of an analog synthesizer.</p>
Cutoff Offset	-63-+63	<p>Cutoff Frequency Offset alters the cutoff frequency of the overall tone, while preserving the relative differences between the cutoff frequency values set for each partial in the Cutoff Frequency parameters (p. 51).</p> <p><b>NOTE</b> This value is added to the cutoff frequency value of a partial, so if the cutoff frequency value of any partial is already set to “<b>127</b>” (maximum), positive (+) value here will not produce any change.</p>
Resonance Offset	-63-+63	<p>Resonance Offset alters the resonance of the overall tone, while preserving the relative differences between the resonance values set for each partial in the Resonance parameter (p. 51).</p> <p>* <b>Resonance:</b> emphasizes the overtones in the region of the cutoff frequency, adding character to the sound.</p> <p><b>NOTE</b> This value is added to the resonance value of a partial, so if the resonance value of any partial is already set to “<b>127</b>” (maximum), positive (+) value here will not produce any change.</p>
Attack Time Offset	-63-+63	<p>Attack Time Offset alters the attack time of the overall tone, while preserving the relative differences between the attack time values set for each partial in the TVA Env Time 1 parameters (p. 54), TVF Env Time 1 parameters (p. 53).</p> <p>* <b>Attack Time:</b> The time it takes for a sound to reach maximum volume after the key is pressed and sound begun.</p> <p><b>NOTE</b> This value is added to the attack time value of a partial, so if the attack time value of any partial is already set to “<b>127</b>” (maximum), positive (+) value here will not produce any change.</p>
Release Time Offset	-63-+63	<p>Release Time Offset alters the release time of the overall tone, while preserving the relative differences between the release time values set for each partial in the TVA Env Time 4 parameters (p. 54), TVF Env Time 4 parameters (p. 53).</p> <p>* <b>Release Time:</b> The time from when you take your finger off the key until the sound disappears.</p> <p><b>NOTE</b> This value is added to the release time value of a partial, so if the release time value of any partial is already set to “<b>127</b>” (maximum), positive (+) value here will not produce any change.</p>
Velocity Sens Offset	-63-+63	<p>Velocity Sensitivity Offset alters the Velocity Sensitivity of the overall tone while preserving the relative differences between the Velocity Sensitivity values set for each partial in the parameters below.</p> <p>Cutoff Velocity Sens parameter (p. 52) Level Velocity Sens parameter (p. 53)</p> <p>* <b>Velocity:</b> Pressure with which the key is pressed.</p> <p><b>NOTE</b> This value is added to the velocity sensitivity value of a partial, so if the velocity sensitivity value of any partial is already set to “<b>+63</b>” (maximum), positive (+) value here will not produce any change.</p>
Mono/Poly	MONO, POLY	<p>Specifies whether the tone will play polyphonically (POLY) or monophonically (MONO). The “<b>MONO</b>” setting is effective when playing a solo instrument tone such as sax or flute.</p> <p><b>MONO:</b> Only the last-played note will sound. <b>POLY:</b> Two or more notes can be played simultaneously.</p>

# PCM Synth Tone (PCMS)

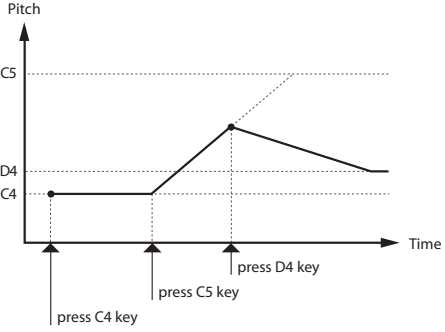
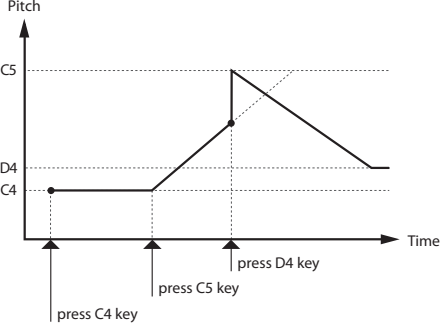
Parameter	Value	Explanation
Legato Switch	OFF, ON	This setting specifies whether the Legato Switch will be used (ON) or not (OFF). Legato Switch is valid when the Mono/Poly parameter is set to <b>"MONO."</b> With the Legato Switch <b>"ON,"</b> pressing a key while continuing to press a previous key causes the note to change pitch to the pitch of the most recently pressed key, sounding all the while. This creates a smooth transition between notes, which is effective when you wish to simulate the hammering on and pulling-off techniques used by a guitarist.
Legato Retrigger	OFF, ON	The setting determines whether sounds are replayed (ON) or not (OFF) when performing legato. The Legato Retrigger is valid when the Mono/Poly is set to <b>"MONO"</b> and the Legato Switch is set to <b>"ON."</b> Normally you will leave this parameter <b>"ON."</b> When <b>"OFF,"</b> when one key is held down and another key is then pressed, only the pitch changes, without the attack of the latter key being played. Set this to <b>"OFF"</b> when performing wind and string phrases or when using modulation with the mono synth keyboard sound. <b>NOTE</b> Let's say you have the Legato Switch set to <b>"ON,"</b> and the Legato Retrigger set to <b>"OFF."</b> When you try to sound a legato (by pressing a higher key while a lower key is held down), the pitch may sometimes not be able to rise all the way to the intended pitch (stopping instead at an intermediate pitch). This can occur because the limit of pitch rise, as determined at the wave level, has been exceeded. Additionally, if differing upper pitch limits are used for the waves of a tone that uses multiple partials, it may stop being heard in MONO. When making large pitch changes, set the Legato Retrigger to <b>"ON."</b>
Portamento Switch	OFF, ON	Specifies whether the portamento effect will be applied (ON) or not (OFF). <b>Portamento</b> Portamento is an effect which smoothly changes the pitch from the first-played key to the next-played key. By applying portamento when the Mono/Poly parameter is <b>"MONO,"</b> you can simulate slide performance techniques on a violin or similar instrument.
Portamento Mode	NORMAL, LEGATO	Specifies the performance conditions for which portamento will be applied. <b>NORMAL:</b> Portamento will always be applied. <b>LEGATO:</b> Portamento will be applied only when you play legato (i.e., when you press the next key before releasing the previous key).
Portamento Type	RATE, TIME	Specifies the type of portamento effect. <b>RATE:</b> The time it takes will depend on the distance between the two pitches. <b>TIME:</b> The time it takes will be constant
Portamento Start	When another key is pressed during a pitch change produced by portamento, a new pitch change will begin. This setting specifies the pitch at which the change will begin.	
	PITCH	Starts a new portamento when another key is pressed while the pitch is changing. 
Portamento Time	Portamento will begin from the pitch where the current change would end.	
	NOTE	Portamento will begin from the pitch where the current change would end. 
Portamento Time	0-127	When portamento is used, this specifies the time over which the pitch will change. Higher settings will cause the pitch change to the next note to take more time.

Parameter	Value	Explanation
Bend Mode	NORMAL, CATCH+LAST	<b>NORMAL:</b> The pitch bend lever works in the conventional way. <b>CATCH+LAST:</b> The pitch lever affects only the last-sounded note. If you play a note while the pitch bend lever is already moved, that note sounds at its normal pitch (as though the lever were in the center). The pitch starts changing only after the lever passes through the center position.

## Wave tab

Partial Switch ([2] (Partial Sw) button)	OFF, ON	Used to specify whether partial 1–4 will be used (ON) or not used (OFF).
Wave Group	INT-A, INT-B, Ex01– (if expansion sound Waves exist)	Selects the group for the waveform that is to be the basis of the partial. <b>INT-A:</b> Internal sound bank A <b>INT-B:</b> Internal sound bank B <b>Ex01–:</b> Expansion sound banks
Wave No.L (Mono)	OFF, 1–	Selects the basic waveform for a tone. Along with the Wave number, the Wave name appears at the lower part of the display. When in monaural mode, only the left side (L) is specified. When in stereo, the right side (R) is also specified.
Wave No.R		<b>NOTE</b> If you specify only the right side (R), there will be no sound.
Wave Gain	-6, 0, +6, +12 dB	Sets the gain (amplification) of the waveform. The value changes in 6 dB (decibel) steps—an increase of 6 dB doubles the waveform's gain. If you intend to use the Booster to distort the waveform's sound, set this parameter to its maximum value (p. 48).
Wave Tempo Sync	OFF, ON	When you wish to synchronize a Phrase Loop to the clock (tempo), set this to <b>"ON."</b> This is available only if there are expansion sounds and you've selected a waveform that indicates the tempo (BPM). If a waveform of an expansion sound is selected for the partial, turning Wave Tempo Sync <b>"ON"</b> disables pitch-related settings and FXM-related settings. When the Wave Tempo Sync is set to <b>"ON,"</b> set the Partial Delay Time (p. 46) to <b>"0."</b> With other settings, a delay effect will be applied, and you will be not be able to play as you expect.  <b>Phrase Loop</b> <b>"Phrase loop"</b> refers to the repeated playback of a phrase that's been pulled out of a song (e.g., by using a sampler). One technique involving the use of Phrase Loops is the excerpting of a Phrase from a pre-existing song in a certain genre, for example dance music, and then creating a new song with that Phrase used as the basic motif. This is referred to as <b>"Break Beats."</b>
FXM Switch	OFF, ON	This sets whether FXM will be used (ON) or not (OFF).  <b>FXM</b> FXM (Frequency Cross Modulation) uses a specified waveform to apply frequency modulation to the currently selected waveform, creating complex overtones. This is useful for creating dramatic sounds or sound effects.
FXM Color	1–4	Specifies how FXM will perform frequency modulation. Higher settings result in a grainier sound, while lower settings result in a more metallic sound.
FXM Depth ★	0–16	Specifies the depth of the modulation produced by FXM. * You can use matrix control to modify this.

# PCM Synth Tone (PCMS)

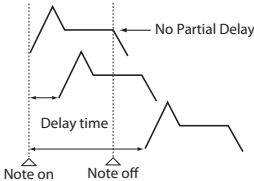
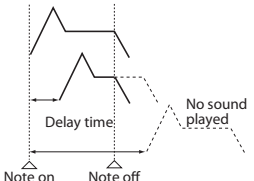
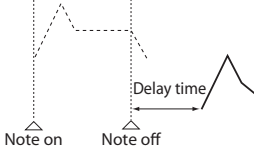
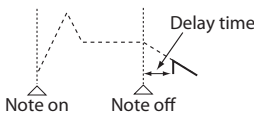
Parameter	Value	Explanation								
Partial Delay Mode	<b>Partial Delay</b>	<p>This produces a time delay between the moment a key is pressed (or released), and the moment the partial actually begins to sound. You can also make settings that shift the timing at which each partial is sounded.</p> <p>This differs from the Delay in the internal effects, in that by changing the sound qualities of the delayed partials and changing the pitch for each partial, you can also perform arpeggio-like passages just by pressing one key.</p> <p>You can also synchronize the partial delay time to the tempo of the external MIDI sequencer.</p> <p><b>NOTE</b></p> <ul style="list-style-type: none"> <li>If you don't wish to use Partial Delay, set Partial Delay Mode to <b>"NORM"</b> and Partial Delay Time to <b>"0."</b></li> <li>If the Structure Type set in the range of <b>"2"–"10,"</b> the output of partial 1 and 2 will be combined into partial 2, and the output of partial 3 and 4 will be combined into partial 4. For this reason, partial 1 will follow the settings of partial 2, and partial 3 will follow the settings of partial 4 (p. 47).</li> </ul>								
	NORM	<p>The partial begins to play after the time specified in the Partial Delay Time parameter has elapsed.</p> 								
	HOLD	<p>Although the partial begins to play after the time specified in the Partial Delay Time parameter has elapsed, if the key is released before the time specified in the Partial Delay Time parameter has elapsed, the partial is not played.</p> 								
	OFF-N	<p>Rather than being played while the key is pressed, the partial begins to play once the period of time specified in the Partial Delay Time parameter has elapsed after release of the key. This is effective in situations such as when simulating noises from guitars and other instruments.</p> 								
	OFF-D	<p>Rather than being played while the key is pressed, the partial begins to play once the period of time specified in the Partial Delay Time parameter has elapsed after release of the key. Here, however, changes in the TVA Envelope begin while the key is pressed, which in many cases means that only the sound from the release portion of the envelope is heard.</p> 								
Partial Delay Time	0–127, Note	<p>Specifies the time from when the key is pressed (or if the Partial Delay Mode parameter is set to <b>"OFF-N"</b> or <b>"OFF-D,"</b> the time from when the key is released) until when the partial will sound.</p> <p>If you want the time until the partial sounds to be synchronized with the tempo, specify the time as a note value relative to the synchronization tempo.</p> <p>(Example) For a tempo of 120 (120 quarter notes occur in 1 minute (60 seconds))</p> <table border="1"> <thead> <tr> <th>Value</th> <th>Partial Delay time</th> </tr> </thead> <tbody> <tr> <td>♩ (half note)</td> <td>1 second (60/60 = 1 <b>[second]</b>)</td> </tr> <tr> <td>♩ (quarter note)</td> <td>0.5 seconds (60/120 = 0.5 <b>[second]</b>)</td> </tr> <tr> <td>♩ (eighth note)</td> <td>0.25 seconds (60/240 = 0.25 <b>[second]</b>)</td> </tr> </tbody> </table>	Value	Partial Delay time	♩ (half note)	1 second (60/60 = 1 <b>[second]</b> )	♩ (quarter note)	0.5 seconds (60/120 = 0.5 <b>[second]</b> )	♩ (eighth note)	0.25 seconds (60/240 = 0.25 <b>[second]</b> )
Value	Partial Delay time									
♩ (half note)	1 second (60/60 = 1 <b>[second]</b> )									
♩ (quarter note)	0.5 seconds (60/120 = 0.5 <b>[second]</b> )									
♩ (eighth note)	0.25 seconds (60/240 = 0.25 <b>[second]</b> )									

Parameter	Value	Explanation
-----------	-------	-------------

PMT tab

<p>Structure Type 1 &amp; 2 Structure Type 3 &amp; 4</p>	<p>1-10</p>	<p>Determines how partial 1 and 2, or partial 3 and 4 are connected. The following 10 different types of combination are available.</p>	
			<p>With this type, partial 1 and 2 (or 3 and 4) are independent. Use this type when you want to preserve PCM sounds or create and combine sounds for each partial.</p>
			<p>This type stacks the two filters together to intensify the characteristics of the filters. The TVA for partial 1 (or 3) controls the volume balance between the two partials.</p>
			<p>This type mixes the sound of partial 1 (3) and partial 2 (4), applies a filter, and then applies a booster to distort the waveform.</p>
			<p>This type applies a booster to distort the waveform, and then combines the two filters. The TVA for partial 1 (or 3) controls the volume balance between the two partials and adjusts booster level.</p>
			<p>This type uses a ring modulator to create new overtones, and combines the two filters. The partial 1 (3) TVA will control the volume balance of the two partials, adjusting the depth of ring modulator.</p>
			<p>This type uses a ring modulator to create new overtones, and in addition mixes in the sound of partial 2 (4) and stacks the two filters. Since the ring-modulated sound can be mixed with partial 2 (4), partial 1 (3) TVA can adjust the amount of the ring-modulated sound.</p>
			<p>This type applies a filter to partial 1 (3) and ring-modulates it with partial 2 (4) to create new overtones.</p>
			<p>This type sends the filtered partial 1 (3) and partial 2 (4) through a ring modulator, and then mixes in the sound of partial 2 (4) and applies a filter to the result.</p>
			<p>This type passes the filtered sound of each partial through a ring modulator to create new overtones. The partial 1 (3) TVA will control the volume balance of the two partials, adjusting the depth of ring modulator.</p>
	<p>This type passes the filtered sound of each partial through a ring modulator to create new overtones, and also mixes in the sound of partial 2 (4). Since the ring-modulated sound can be mixed with partial 2 (4), partial 1 (3) TVA can adjust the amount of the ring-modulated sound.</p>		

# PCM Synth Tone (PCMS)

Parameter	Value	Explanation
<b>Booster 1 &amp; 2</b> <b>Booster 3 &amp; 4</b>	0, +6, +12, +18 dB	<p>When a Structure Type of TYPE 3 or TYPE 4 is selected, you can adjust the depth of the booster. The booster increases the input signal in order to distort the sound. This creates the distortion effect frequently used with electric guitars. Higher settings will produce more distortion.</p> <p><b>Booster</b></p> <p>The Booster is used to distort the incoming signal. In addition to using this to create distortion, you can use the waveform (WG1) of one of the partials as an LFO which shifts the other waveform (WG2) upward or downward to create modulation similar to PWM (pulse width modulation). This parameter works best when you use it in conjunction with the Wave Gain parameter (p. 45).</p>

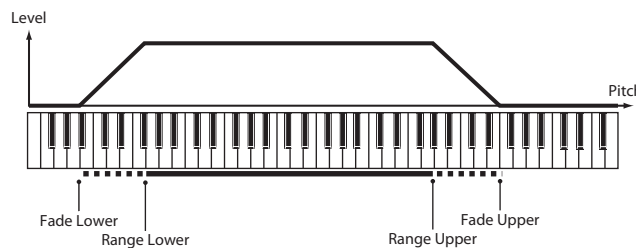

Key Fade Upper	0–127	This determines what will happen to the tone's level when a note that's higher than the partial's specified keyboard range is played. Higher settings produce a more gradual change in volume. If you don't want the tone to sound at all when a note above the keyboard range is played, set this parameter to "0."
Key Range Upper	LOWER–G9	Specifies the highest note that the tone will sound for each partial.
Key Range Lower	C-1–UPPER	Specifies the lowest note that the tone will sound for each partial. <b>NOTE</b> If you attempt to raise the lower key higher than the upper key, or to lower the upper key below the lower key, the other value will be automatically modified to the same setting.
Key Fade Lower	0–127	This determines what will happen to the tone's level when a note that's lower than the partial's specified keyboard range is played. Higher settings produce a more gradual change in volume. If you don't want the tone to sound at all when a note below the keyboard range is played, set this parameter to "0."
PMT Velocity Control	OFF, ON, RANDOM, CYCLE	<p>PMT Velocity Control determines whether a different partial is played (ON) or not (OFF) depending on the force with which the key is played (velocity).</p> <p>When set to "RANDOM," the tone's constituent partials will sound randomly, regardless of any velocity messages.</p> <p>When set to "CYCLE," the tone's constituent partials will sound consecutively, regardless of any velocity messages.</p> <p><b>MEMO</b></p> <p>Use "Velo Range Lower" (p. 49) and "Velo Range Upper" (p. 49) to specify the range of keyboard dynamics.</p> <p><b>NOTE</b></p> <ul style="list-style-type: none"> <li>If Velocity Range Lower and Velocity Range Upper are set to the same values, you won't be able to obtain any effect by setting PMT Velocity Control to "RANDOM" or "CYCLE."</li> <li>Instead of using Velocity, you can also have partials substituted using the Matrix Control (p. 58). However, the keyboard velocity and the Matrix Control cannot be used simultaneously to make different partials to sound. When using the Matrix Control to switch partials, set the Velocity Control parameter to "OFF."</li> </ul>



Parameter	Value	Explanation
Velo Fade Upper	0-127	This determines what will happen to the tone's level when the tone is played at a velocity greater than its specified velocity range. Higher settings produce a more gradual change in volume. If you want notes played outside the specified key velocity range to not be sounded at all, set this to "0."
Velo Range Upper	LOWER-127	This sets the highest velocity at which the partial will sound. Make these settings when you want different partials to sound in response to notes played at different strengths.
Velo Range Lower	1-UPPER	This sets the lowest velocity at which the partial will sound. Make these settings when you want different partial to sound in response to notes played at different strengths. <b>NOTE</b> If you attempt to set the Lower velocity limit above the Upper, or the Upper below the Lower, the other value will automatically be adjusted to the same setting. When using the Matrix Control (p. 58) to have different partials played, set the lowest value (Lower) and highest value (Upper) of the value of the MIDI message used.
Velo Fade Lower	0-127	This determines what will happen to the tone's level when the tone is played at a velocity lower than its specified velocity range. Higher settings produce a more gradual change in volume. If you want notes played outside the specified key velocity range to not be sounded at all, set this to "0."
PMT Control Switch	OFF, ON	Use the Matrix Control (p. 58) to enable (ON), or disable (OFF) sounding of different partials. <b>NOTE</b> You can also cause different partials to sound in response to notes played at different strengths (velocity) on the keyboard (p. 48). However, the Matrix Control and the keyboard velocity cannot be used simultaneously to make different partials to sound. When using the Matrix Control to have different partials to sound, set the Velocity Control parameter (p. 48) to "OFF."

## Pitch tab

Partial Coarse Tune ★	-48-+48	Adjusts the pitch of the partial's sound up or down in semitone steps (+/-4 octaves). * You can control this parameter using the Matrix Control.
Partial Fine Tune ★	-50-+50	Adjusts the pitch of the partial's sound up or down in 1-cent steps (+/-50 cents). * You can control this parameter using the Matrix Control. * One cent is 1/100th of a semitone.
Random Pitch Depth	0, 1, 2, 3, 4, 5, 6, 7, 8, 9, 10, 20, 30, 40, 50, 60, 70, 80, 90, 100, 200, 300, 400, 500, 600, 700, 800, 900, 1000, 1100, 1200	This specifies the width of random pitch deviation that will occur each time a key is pressed. If you do not want the pitch to change randomly, set this to "0." These values are in units of cents (1/100th of a semitone).
Pitch Keyfollow	-200-+200	This specifies the amount of pitch change that will occur when you play a key one octave higher (i.e., 12 keys upward on the keyboard). If you want the pitch to rise one octave as on a conventional keyboard, set this to "+100." If you want the pitch to rise two octaves, set this to "+200." Conversely, set this to a negative (-) value if you want the pitch to fall. With a setting of "0," all keys will produce the same pitch. 
Pitch Bend Range Up	0-+48	Specifies the degree of pitch change in semitones when the Pitch Bend lever is all the way right. For example, if this parameter is set to "12," the pitch will rise one octave when the pitch bend lever is moved to the right-most position.

# PCM Synth Tone (PCMS)

Parameter	Value	Explanation
Pitch Bend Range Down	0--48	Specifies the degree of pitch change in semitones when the Pitch Bend lever is all the way left. For example if this is set to "-48" and you move the pitch bend lever all the way to the left, the pitch will fall 4 octaves.

## Pitch Env tab

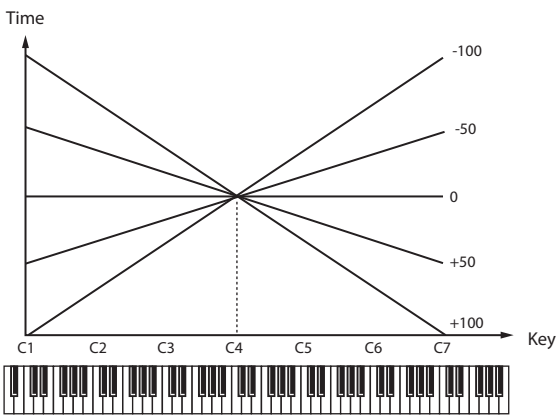
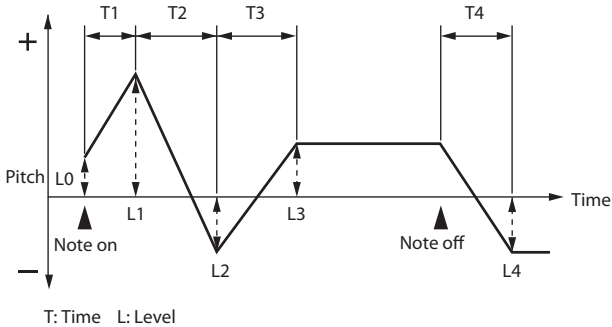
Pitch Env Depth	-12--+12	Adjusts the effect of the Pitch Envelope. Higher settings will cause the pitch envelope to produce greater change. Negative (-) value will invert the shape of the envelope.
Pitch Env V-Sens	-63--+63	Keyboard playing dynamics can be used to control the depth of the pitch envelope. If you want the pitch envelope to have more effect for strongly played notes, set this parameter to a positive (+) value. If you want the pitch envelope to have less effect for strongly played notes, set this to a negative (-) value.
Pitch Env T1 V-Sens	-63--+63	This allows keyboard dynamics to affect the Time 1 of the Pitch envelope. If you want Time 1 to be speeded up for strongly played notes, set this parameter to a positive (+) value. If you want it to be slowed down, set this to a negative (-) value.
Pitch Env T4 V-Sens	-63--+63	Use this parameter when you want key release speed to affect the Time 4 value of the pitch envelope. If you want Time 4 to be speeded up for quickly released notes, set this parameter to a positive (+) value. If you want it to be slowed down, set this to a negative (-) value.
Pitch Env Time KF	-100--+100	Use this setting if you want the pitch envelope times (Time 2–Time 4) to be affected by the keyboard location. Based on the pitch envelope times for the C4 key, positive (+) value will cause notes higher than C4 to have increasingly shorter times, and negative (-) value will cause them to have increasingly longer times. Larger settings will produce greater change. 
Pitch Env Time 1–4 ★	0–127	Specify the pitch envelope times (Time 1–Time 4). Higher settings will result in a longer time until the next pitch is reached (For example, Time 2 is the time over which the pitch changes from Level 1 to Level 2). * You can control this parameter using the Matrix Control. 
Pitch Env Level 0–4	-63--+63	Specify the pitch envelope levels (Level 0–Level 4). It determines how much the pitch changes from the reference pitch (the value set with Coarse Tune or Fine Tune on the Pitch screen) at each point. Positive (+) value will cause the pitch to be higher than the standard pitch, and negative (-) value will cause it to be lower.

Parameter	Value	Explanation
-----------	-------	-------------

## TVF tab

Filter Type	Selects the type of filter. A filter cuts or boosts a specific frequency region to change a sound's brightness, thickness, or other qualities.	
	OFF	No filter is used.
	LPF	Low Pass Filter. This reduces the volume of all frequencies above the cutoff frequency (Cutoff Freq) in order to round off, or un-brighten the sound. This is the most common filter used in synthesizers.
	BPF	Band Pass Filter. This leaves only the frequencies in the region of the cutoff frequency (Cutoff Freq), and cuts the rest. This can be useful when creating distinctive sounds.
	HPF	High Pass Filter. This cuts the frequencies in the region below the cutoff frequency (Cutoff Freq). This is suitable for creating percussive sounds emphasizing their higher tones.
	PKG	Peaking Filter. This emphasizes the frequencies in the region of the cutoff frequency (Cutoff Freq). You can use this to create wah-wah effects by employing an LFO to change the cutoff frequency cyclically.
	LPF2	Low Pass Filter 2. Although frequency components above the Cutoff frequency (Cutoff Freq) are cut, the sensitivity of this filter is half that of the LPF. This makes it a comparatively warmer low pass filter. This filter is good for use with simulated instrument sounds such as the acoustic piano. <b>* If you set "LPF2," the setting for the Resonance parameter will be ignored (p. 51).</b>
	LPF3	Low Pass Filter 3. Although frequency components above the Cutoff frequency (Cutoff Freq) are cut, the sensitivity of this filter changes according to the Cutoff frequency. While this filter is also good for use with simulated acoustic instrument sounds, the nuance it exhibits differs from that of the LPF2, even with the same TVF Envelope settings. <b>* If you set "LPF3," the setting for the Resonance parameter will be ignored (p. 51).</b>
Cutoff Frequency ★	0-127	<p>Selects the frequency at which the filter begins to have an effect on the waveform's frequency components.</p> <p>With <b>"LPF/LPF2/LPF3"</b> selected for the Filter Type parameter, lower cutoff frequency settings reduce a tone's upper harmonics for a more rounded, warmer sound. Higher settings make it sound brighter.</p> <p>If <b>"BPF"</b> is selected, harmonic components will change depending on the TVF Cutoff Frequency setting. This can be useful when creating distinctive sounds.</p> <p>With <b>"HPF"</b> selected, higher Cutoff Frequency settings will reduce lower harmonics to emphasize just the brighter components of the sound.</p> <p>With <b>"PKG"</b> selected, the harmonics to be emphasized will vary depending on Cutoff Frequency setting.</p> <p><b>* You can control this parameter using the Matrix Control.</b></p> <p><b>MEMO</b></p> <p>To edit the overall tone while preserving the relative differences in the Cutoff Frequency values set for each partial, set the Cutoff Offset parameter (p. 43).</p>
Resonance ★	0-127	<p>Emphasizes the portion of the sound in the region of the cutoff frequency, adding character to the sound. Excessively high settings can produce oscillation, causing the sound to distort.</p> <p><b>* You can control this parameter using the Matrix Control.</b></p> <p><b>MEMO</b></p> <p>To edit the overall tone while preserving the relative differences in the Resonance values set for each partial, set the Resonance Offset parameter (p. 43).</p>

## PCM Synth Tone (PCMS)

Parameter	Value	Explanation
Cutoff Keyfollow	-200+200	<p>Use this parameter if you want the cutoff frequency to change according to the key that is pressed. Relative to the cutoff frequency at the C4 key (center C), positive (+) value will cause the cutoff frequency to rise for notes higher than C4, and negative (-) value will cause the cutoff frequency to fall for notes higher than C4.</p> <p>Larger settings will produce greater change.</p> <p>Cutoff frequency (Octave)</p>
Cutoff V-Curve	FIXED, 1-7	<p>Selects one of the following seven curves that determine how keyboard playing dynamics (velocity) influence the cutoff frequency. Set this to <b>“FIXED”</b> if you don't want the Cutoff frequency to be affected by the keyboard velocity.</p>
Cutoff V-Sens	-63+63	<p>Use this parameter when changing the cutoff frequency to be applied as a result of changes in playing velocity. If you want strongly played notes to raise the cutoff frequency, set this parameter to positive (+) value. If you want strongly played notes to lower the cutoff frequency, use negative (-) value.</p> <p><b>MEMO</b></p> <p>To edit the overall tone while preserving the relative differences in the Cutoff V-Sens values set for each partial, set the Velocity Sens Offset parameter (p. 43). However, this setting is shared by the Level V-Sens parameter (p. 53).</p>
Resonance V-Sens	-63+63	<p>This allows keyboard velocity to modify the amount of Resonance. If you want strongly played notes to have a greater Resonance effect, set this parameter to positive (+) value. If you want strongly played notes to have less Resonance, use negative (-) value.</p>

## TVF Env tab

TVF Env Depth	-63+63	<p>Specifies the depth of the TVF envelope. Higher settings will cause the TVF envelope to produce greater change. Negative (-) value will invert the shape of the envelope.</p>
TVF Env V-Curve	FIXED, 1-7	<p>Selects one of the following seven curves that will determine how keyboard playing dynamics will affect the TVF envelope. Set this to <b>“FIXED”</b> if you don't want the TVF Envelope to be affected by the keyboard velocity.</p>
TVF Env V-Sens	-63+63	<p>Specifies how keyboard playing dynamics will affect the depth of the TVF envelope. Positive (+) value will cause the TVF envelope to have a greater effect for strongly played notes, and negative (-) value will cause the effect to be less.</p>
TVF Env T1 V-Sens	-63+63	<p>This allows keyboard dynamics to affect the Time 1 of the TVF envelope. If you want Time 1 to be speeded up for strongly played notes, set this parameter to a positive (+) value. If you want it to be slowed down, set this to a negative (-) value.</p>
TVF Env T4 V-Sens	-63+63	<p>The parameter to use when you want key release speed to control the Time 4 value of the TVF envelope. If you want Time 4 to be speeded up for quickly released notes, set this parameter to a positive (+) value. If you want it to be slowed down, set this to a negative (-) value.</p>

Parameter	Value	Explanation
TVF Env Time KF	-100~+100	<p>Use this setting if you want the TVF envelope times (Time 2–Time 4) to be affected by the keyboard location. Based on the TVF envelope times for the C4 key (center C), positive (+) value will cause notes higher than C4 to have increasingly shorter times, and negative (-) value will cause them to have increasingly longer times. Larger settings will produce greater change.</p>
TVF Env Time 1–4 ★	0–127	<p>Specify the TVF envelope times (Time 1–Time 4). Higher settings will lengthen the time until the next cutoff frequency level is reached (For example, Time 2 is the time over which Level 1 will change to Level 2).</p> <p>* You can control this parameter using the Matrix Control.</p>
TVF Env Level 0-4	0–127	<p>Specify the TVF envelope levels (Level 0–Level 4). These settings specify how the cutoff frequency will change at each point, relative to the standard cutoff frequency (the cutoff frequency value specified in the TVF screen).</p>

### TVA tab

Partial Level ★	0–127	<p>Sets the volume of the partial. This setting is useful primarily for adjusting the volume balance between partials.</p> <p>* You can control this parameter using the Matrix Control.</p>
Level V-Curve	FIXED, 1–7	<p>Selects one of the following seven curves that determine how keyboard dynamics will affect the volume. Set this to “FIXED” if you don’t want the volume of the partial to be affected by the keyboard velocity.</p>
Level V-Sens	-63~+63	<p>Set this when you want the volume of the partial to change depending on the force with which you press the keys. Set this to a positive (+) value to have the changes in partial volume increase the more forcefully the keys are played; to make the partial play more softly as you play harder, set this to a negative (-) value.</p> <p><b>MEMO</b></p> <p>If you wish to make adjustments to the entire tone while maintaining the relative values of TVA Level V-Sens among partials, adjust the Velocity Sens Offset parameter (p. 43). However, this setting is shared by the Cutoff V-Sens parameter (p. 52).</p>
Bias Level	-100~+100	<p>Adjusts the angle of the volume change that will occur in the selected Bias Direction. Larger settings will produce greater change.</p> <p>Negative (-) values will invert the change direction.</p>
Bias Position	C-1–G9	<p>Specifies the key relative to which the volume will be modified.</p>
Bias Direction	Selects the direction in which change will occur starting from the Bias Position.	
	LWR	The volume will be modified for the keyboard area below the Bias Point.
	UPR	The volume will be modified for the keyboard area above the Bias Point.
	ALL	The volume changes linearly with the bias point at the center.

## PCM Synth Tone (PCMS)

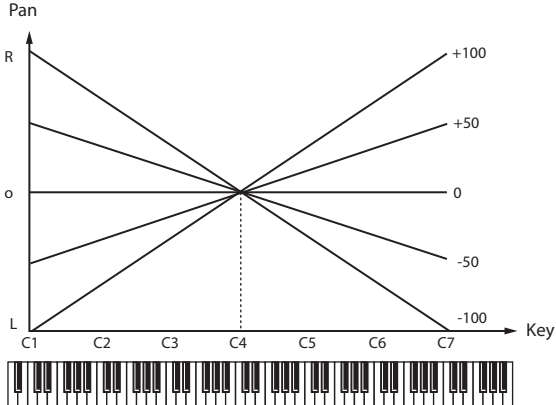
Parameter	Value	Explanation
Partial Pan ★	L64–63R	<p>Sets the pan of the partial. “L64” is far left, “0” is center, and “63R” is far right.</p> <p>* You can control this parameter using the Matrix Control.</p>
Pan Keyfollow	-100–+100	<p>Use this parameter if you want key position to affect panning. Positive (+) value will cause notes higher than C4 key (center C) to be panned increasingly further toward the right, and negative (-) value will cause notes higher than C4 key (center C) to be panned toward the left. Larger settings will produce greater change.</p> 
Random Pan Depth	0–63	Use this parameter when you want the stereo location to change randomly each time you press a key. Higher settings will produce a greater amount of change.
Alternate Pan Depth	L63–63R	<p>This setting causes panning to be alternated between left and right each time a key is pressed. Higher settings will produce a greater amount of change. “L” or “R” settings will reverse the order in which the pan will alternate between left and right. For example if two partials are set to “L” and “R” respectively, the panning of the two tones will alternate each time they are played.</p> <p><b>NOTE</b> In the Pan Key Follow, Random Pan Depth, and Alternate Pan Depth parameter settings, if the Structure Type set in the range of “2”–“10,” the output of partial 1 and 2 will be combined into partial 2, and the output of partial 3 and 4 will be combined into partial 4. For this reason, partial 1 will follow the settings of partial 2, and partial 3 will follow the settings of partial 4 (p. 47).</p>

## TVA Env tab

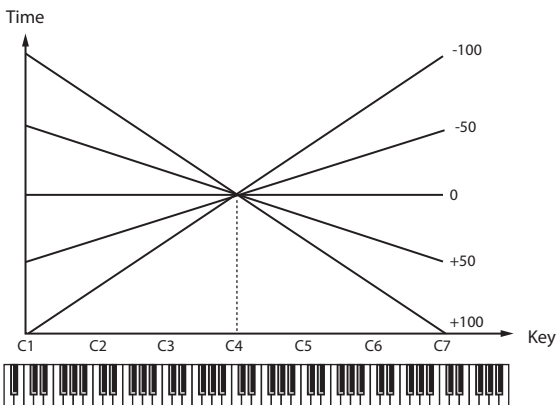
TVA Env T1 V-Sens	-63–+63	This allows keyboard dynamics to affect the Time 1 of the TVA envelope. If you want Time 1 to be speeded up for strongly played notes, set this parameter to a positive (+) value. If you want it to be slowed down, set this to a negative (-) value.
TVA Env T4 V-Sens	-63–+63	The parameter to use when you want key release speed to control the Time 4 value of the TVA envelope. If you want Time 4 to be speeded up for quickly released notes, set this parameter to a positive (+) value. If you want it to be slowed down, set this to a negative (-) value.
TVA Env Time KF	-100–+100	<p>Use this setting if you want the TVA envelope times (Time 2–Time 4) to be affected by the keyboard location. Based on the TVA envelope times for the C4 key (center C), positive (+) value will cause notes higher than C4 to have increasingly shorter times, and negative (-) value will cause them to have increasingly longer times. Larger settings will produce greater change.</p> 
TVA Env Time 1–4 ★	0–127	<p>Specify the TVA envelope times (Time 1– Time 4). Higher settings will lengthen the time until the next volume level is reached (For example, Time 2 is the time over which Level 1 will change to Level 2).</p> <p>* You can control this parameter using the Matrix Control.</p>

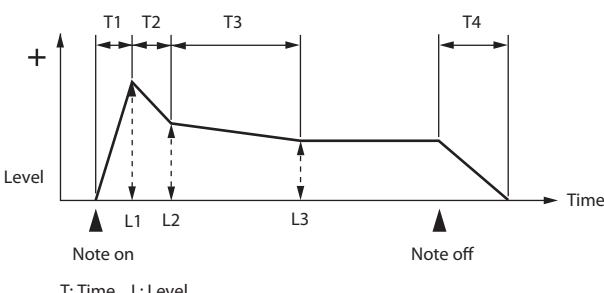
Parameter	Value	Explanation
TVA Env Level 1-3	0-127	<p>Specify the TVA envelope levels (Level 1–Level 3). These settings specify how the volume will change at each point, relative to the standard volume (the Partial Level value specified in the TVA screen).</p>  <p>* If you set TVA Env Level 3 near <b>“0,”</b> the sound may decay if you continue playing legato. If this occurs, you can raise the TVA Env Level 3 value so that the sound continues.</p>

### Output tab

Output Level	0-127	Specifies the signal level of each partial.
Chorus Send Level	0-127	Specifies the level of the signal sent to the chorus for each partial.
Reverb Send Level	0-127	Specifies the level of the signal sent to the reverb for each partial.

### LF01/LF02 tab

An LFO (Low Frequency Oscillator) causes change over a cycle in a sound. Each partial has two LFOs (LFO1/LFO2), and these can be used to cyclically change the pitch, cutoff frequency and volume to create modulation-type effects such as vibrato, wah and tremolo. Both LFOs have the same parameters.

Waveform	Selects the waveform of the LFO.									
	SIN	Sine wave								
	TRI	Triangle wave								
	SAW-U	Sawtooth wave								
	SAW-D	Sawtooth wave (negative polarity)								
	SQR	Square wave								
	RND	Random wave								
	BND-U	Once the attack of the waveform output by the LFO is allowed to develop in standard fashion, the waveform then continues without further change. <b>NOTE</b> You must turn the Key Trigger parameter to <b>“ON.”</b> If this is <b>“OFF,”</b> it will have no effect.								
	BND-D	Once the decay of the waveform output by the LFO is allowed to develop in standard fashion, the waveform then continues without further change. <b>NOTE</b> You must turn the Key Trigger parameter to <b>“ON.”</b> If this is <b>“OFF,”</b> it will have no effect.								
	TRP	Trapezoidal wave								
	S&H	Sample & Hold wave (one time per cycle, LFO value is changed)								
	CHAOS	Chaos wave								
	VSIN	Modified sine wave. The amplitude of a sine wave is randomly varied once each cycle.								
STEP	A waveform generated by the data specified by LFO Step 1–64. This produces stepped change with a fixed pattern similar to a step modulator.									
Rate ★	0-127, Note	<p>Adjusts the modulation rate, or speed, of the LFO.</p> <p>If you want the LFO rate to be synchronized with the tempo, specify the setting as a note value relative to the synchronization tempo.</p> <p>* You can control this parameter using the Matrix Control.</p> <p>(Example) For a tempo of 120 (120 quarter notes occur in 1 minute (60 seconds))</p> <table border="1" data-bbox="730 1832 1401 1989"> <thead> <tr> <th>Value</th> <th>LFO Rate</th> </tr> </thead> <tbody> <tr> <td>♩ (half note)</td> <td>1 second (60/60 = 1 <b>[second]</b>)</td> </tr> <tr> <td>♩ (quarter note)</td> <td>0.5 seconds (60/120 = 0.5 <b>[second]</b>)</td> </tr> <tr> <td>♩ (eighth note)</td> <td>0.25 seconds (60/240 = 0.25 <b>[second]</b>)</td> </tr> </tbody> </table> <p><b>NOTE</b> This setting will be ignored if the Waveform parameter is set to <b>“CHAOS.”</b></p>	Value	LFO Rate	♩ (half note)	1 second (60/60 = 1 <b>[second]</b> )	♩ (quarter note)	0.5 seconds (60/120 = 0.5 <b>[second]</b> )	♩ (eighth note)	0.25 seconds (60/240 = 0.25 <b>[second]</b> )
		Value	LFO Rate							
♩ (half note)	1 second (60/60 = 1 <b>[second]</b> )									
♩ (quarter note)	0.5 seconds (60/120 = 0.5 <b>[second]</b> )									
♩ (eighth note)	0.25 seconds (60/240 = 0.25 <b>[second]</b> )									

## PCM Synth Tone (PCMS)

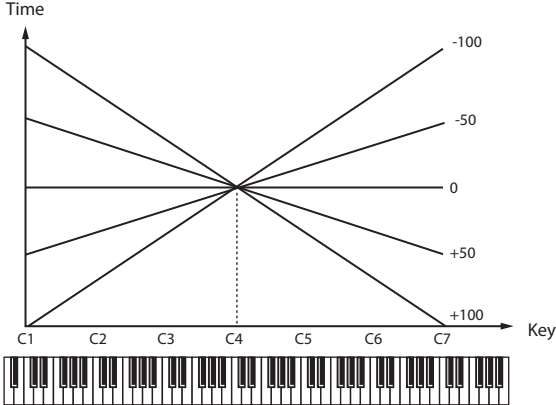
Parameter	Value	Explanation
Rate Detune	0–127	LFO Rate Detune makes subtle changes in the LFO cycle rate (Rate parameter) each time a key is pressed. Higher settings will cause greater change. This parameter is invalid when Rate is set to <b>“note.”</b>
Offset	-100, -50, 0, +50, +100	Raises or lowers the LFO waveform relative to the central value (pitch or cutoff frequency). Positive (+) value will move the waveform so that modulation will occur from the central value upward. Negative (-) value will move the waveform so that modulation will occur from the central value downward.
Delay Time	0–127	Delay Time (LFO Delay Time) specifies the time elapsed before the LFO effect is applied (the effect continues) after the key is pressed (or released).  * After referring to <b>“How to Apply the LFO”</b> (p. 57), change the setting until the desired effect is achieved.  <b>MEMO</b> When using violin, wind, or certain other instrument sounds in a performance, rather than having vibrato added immediately after the sounds are played, it can be effective to add the vibrato after the note is drawn out somewhat. If you set the Delay Time in conjunction with the Pitch Depth parameter and Rate parameter, the vibrato will be applied automatically following a certain interval after the key is pressed. This effect is called <b>“Delay Vibrato.”</b>
Delay Time KF	-100→+100	Adjusts the value for the Delay Time parameter depending on the key position, relative to the C4 key (center C). To decrease the time that elapses before the LFO effect is applied (the effect is continuous) with each higher key that is pressed in the upper registers, select a positive (+) value; to increase the elapsed time, select a negative (-) value. Larger settings will produce greater change. If you do not want the elapsed time before the LFO effect is applied (the effect is continuous) to change according to the key pressed, set this to <b>“0.”</b>  
Fade Mode	ON<, ON>, OFF<, OFF>	Specifies how the LFO will be applied.  * After referring to <b>“How to Apply the LFO”</b> (p. 57), change the setting until the desired effect is achieved.
Fade Time	0–127	Specifies the time over which the LFO amplitude will reach the maximum (minimum).  * After referring to <b>“How to Apply the LFO”</b> (p. 57), change the setting until the desired effect is achieved.
Key Trigger	OFF, ON	Specifies whether the LFO cycle will be synchronized to begin when the key is pressed (ON) or not (OFF).
Pitch Depth ★	-63→+63	Specifies how deeply the LFO will affect pitch.  * You can control this parameter using the Matrix Control.
TVF Depth ★	-63→+63	Specifies how deeply the LFO will affect the cutoff frequency.  * You can control this parameter using the Matrix Control.
TVA Depth ★	-63→+63	Specifies how deeply the LFO will affect the volume.  * You can control this parameter using the Matrix Control.
Pan Depth ★	-63→+63	Specifies how deeply the LFO will affect the pan.  * You can control this parameter using the Matrix Control.  <b>MEMO</b> Positive (+) and negative (-) value for the Depth parameter result in differing kinds of change in pitch and volume. For example, if you set the Depth parameter to a positive (+) value for one partial, and set another partial to the same numerical value, but make it negative (-), the modulation phase for the two partials will be the reverse of each other. This allows you to shift back and forth between two different partials, or combine it with the Pan setting to cyclically change the location of the sound image.  <b>NOTE</b> In the Pan Depth parameter settings, if the Structure Type parameter is set to any value from <b>“2”</b> through <b>“10,”</b> the output of partial 1 and 2 will be combined into partial 2, and the output of partial 3 and 4 will be combined into partial 4. For this reason, partial 1 will follow the settings of partial 2, and partial 3 will follow the settings of partial 4 (p. 47).



Parameter	Value	Explanation
-----------	-------	-------------

## Step LFO tab

Step Type	TYP1, TYP2	When generating an LFO waveform from the data specified in LFO Step1-16, specify whether the level will change abruptly at each step (TYP1) or will be connected linearly (TYP2).
LFO Step1-16	-36~+36	Specifies the data for the Step LFO. If the LFO Pitch Depth is +63, each +1 unit of the step data corresponds to a pitch of +50 cents.

## How to Apply the LFO

### Apply the LFO gradually after the key is pressed

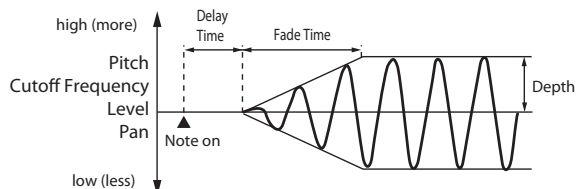

Parameter	Explanation
Fade Mode	ON <
Delay Time	The time from when the keyboard is played until the LFO begins to be applied.
Fade Time	The time over which the LFO amplitude will reach the maximum after the Delay Time has elapsed.

### Apply the LFO immediately when the key is pressed, and then gradually begin to decrease the effect

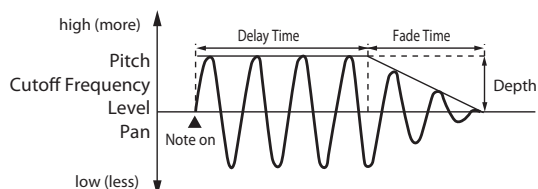

Parameter	Explanation
Fade Mode	ON >
Delay Time	The time that the LFO will continue after the keyboard is played.
Fade Time	The time over which the LFO amplitude will reach the minimum after the Delay Time has elapsed.

### Apply the LFO gradually after the key is released

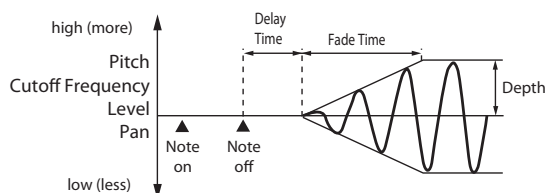

Parameter	Explanation
Fade Mode	OFF <
Delay Time	The time from when the keyboard is released until the LFO begins to be applied.
Fade Time	The time over which the LFO amplitude will reach the maximum after the Delay Time has elapsed.

### Apply the LFO from when the key is pressed until it is released, and gradually begin to decrease the effect when the key is released

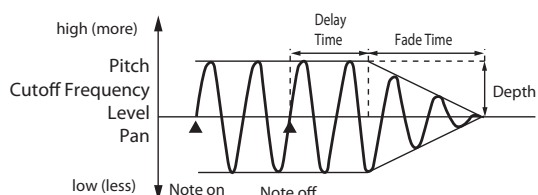

Parameter	Explanation
Fade Mode	OFF >
Delay Time	The time that the LFO will continue after the keyboard is released.
Fade Time	The time over which the LFO amplitude will reach the minimum after the Delay Time has elapsed.

## PCM Synth Tone (PCMS)

Parameter	Value	Explanation
<b>Control tab</b>		
Env Mode	NOSUS, SUST	When a loop waveform is selected, the sound will normally continue as long as the key is pressed. If you want the sound to decay naturally even if the key remains pressed, set this to <b>"NOSUS."</b> <b>NOTE</b> If a one-shot type Wave is selected, it will not sustain even if this parameter is set to <b>"SUST."</b>
Rx Bender	OFF, ON	For each partial, specify whether MIDI Pitch Bend messages will be received (ON), or not (OFF).
Rx Expression	OFF, ON	For each partial, specify whether MIDI Expression messages will be received (ON), or not (OFF).
Rx Hold-1	OFF, ON	For each partial, specify whether MIDI Hold-1 messages will be received (ON), or not (OFF). <b>NOTE</b> If <b>"NOSUS"</b> is selected for Env Mode parameter, this setting will have no effect.
Redamper Sw	OFF, ON	You can specify, on an individual partial basis, whether or not the sound will be held when a Hold 1 message is received after a key is released, but before the sound has decayed to silence. If you want to sustain the sound, set this <b>"ON."</b> When using this function, also set the Rx Hold-1 parameter <b>"ON."</b> This function is effective for piano sounds.

## Matrix Control 1–4 tab

### Matrix Control

Ordinarily, if you wanted to change partial parameters using an external MIDI device, you would need to send System Exclusive messages-MIDI messages designed exclusively for the FA. However, System Exclusive messages tend to be complicated, and the amount of data that needs to be transmitted can get quite large.

For that reason, a number of the more typical of the FA's partial parameters have been designed so they accept the use of Control Change (or other) MIDI messages for the purpose of making changes in their values. This provides you with a variety of means of changing the way tones are played. For example, you can use the Pitch Bend lever to change the LFO cycle rate, or use the keyboard's touch to open and close a filter.

The function which allows you use MIDI messages to make these changes in realtime to the partial parameters is called the **"Matrix Control."** Up to four Matrix Controls can be used in a single tone.

To use the Matrix Control, specify which MIDI message (Src) will be used to control which parameter (Dest), and how greatly (Sns), and the partial to which the effect is applied (Switch).

Control1–4 Source	OFF, CC01–CC31, CC33–CC95, PITCH BEND, AFTERTOUCHE, SYS CTRL1–4, VELOCITY, KEYFOLLOW, TEMPO, LFO1, LFO2, PITCH ENV, TVF ENV, TVA ENV	<p>Sets the MIDI message used to change the partial parameter with the Matrix Control.</p> <p><b>OFF:</b> Matrix control will not be used.</p> <p><b>CC01–31, 33–95:</b> Controller numbers 1–31, 33–95</p> <p><b>PITCH BEND:</b> Pitch Bend</p> <p><b>AFTERTOUCHE:</b> Aftertouch</p> <p><b>SYS CTRL1–4:</b> MIDI messages used as common matrix controls.</p> <p><b>VELOCITY:</b> Velocity (pressure you press a key with)</p> <p><b>KEYFOLLOW:</b> Keyfollow (keyboard position with C4 as 0)</p> <p><b>TEMPO:</b> Tempo specified by the tempo assign source, or the tempo of an external MIDI sequencer</p> <p><b>LFO1:</b> LFO 1</p> <p><b>LFO2:</b> LFO 2</p> <p><b>PITCH ENV:</b> Pitch envelope</p> <p><b>TVF ENV:</b> TVF envelope</p> <p><b>TVA ENV:</b> TVA envelope</p> <ul style="list-style-type: none"> <li>* Velocity and Keyfollow correspond to Note messages.</li> <li>* Although there are no MIDI messages for LFO 1 through TVA Envelope, they can be used as Matrix Control. In this case, you can change the partial settings in realtime by playing tones.</li> <li>* If you want to use common controllers for the entire FA, select <b>"SYS CTRL1"–"SYS CTRL4."</b> MIDI messages used as System Control 1–4 are set with the Tone Control 1–4 Src (p. 5).</li> </ul> <p><b>Reference</b></p> <p>For more information about Control Change messages, please refer to <b>"MIDI Implementation (PDF)."</b></p> <p><b>NOTE</b></p> <ul style="list-style-type: none"> <li>• There are parameters that determine whether or not Pitch Bend, Controller Number 11 (Expression) and Controller Number 64 (Hold 1) are received (p. 58). When these settings are <b>"ON,"</b> and the MIDI messages are received, then when any change is made in the settings of the desired parameter, the Pitch Bend, Expression, and Hold 1 settings also change simultaneously. If you want to change the targeted parameters only, then set these to <b>"OFF."</b></li> <li>• There are parameters that let you specify whether specific MIDI messages will be received for each part in a studio set (p. 13). When a tone with Matrix Control settings is assigned to a part, confirm that any MIDI messages used for the Matrix Control will be received. If the FA is set up such that reception of MIDI messages is disabled, then the Matrix Control will not function.</li> </ul>
-------------------	---	--

Parameter	Value	Explanation
Control1-4 Dest1-4	OFF, PITCH, CUTOFF, RESONANCE, LEVEL, PAN, OUTPUT LEVEL, CHORUS SEND, REVERB SEND, LFO1/LFO2 PITCH DEPTH, LFO1/LFO2 TVF DEPTH, LFO1/LFO2 TVA DEPTH, LFO1/LFO2 PAN DEPTH, LFO1/LFO2 RATE, PIT ENV A-TIME, PIT ENV D-TIME, PIT ENV R-TIME, TVF ENV A-TIME, TVF ENV D-TIME, TVF ENV R-TIME, TVA ENV A-TIME, TVA ENV D-TIME, TVA ENV R-TIME, PMT, FXM DEPTH	<p>Selects the partial parameter that is to be controlled when using the Matrix Control. The following parameters can be controlled. When not controlling parameters with the Matrix Control, set this to <b>"OFF."</b> Up to four parameters can be specified for each Matrix Control, and controlled simultaneously.</p> <p><b>MEMO</b></p> <p>In this manual, Parameters that can be controlled using the Matrix Control (p. 58) are marked with a <b>"★"</b></p> <p><b>If you're not using Matrix Control</b>  <b>OFF:</b> Matrix Control will not be used.</p> <p><b>Changing the Pitch</b>  <b>PITCH:</b> Changes the pitch.</p> <p><b>Opening and Closing the Filter</b>  <b>CUTOFF:</b> Changes the cutoff frequency.  <b>RESONANCE:</b> Emphasizes the overtones in the region of the cutoff frequency, adding character to the sound.</p> <p><b>Changing the Volume and Pan</b>  <b>LEVEL:</b> Changes the volume level.  <b>PAN:</b> Changes the pan.</p> <p><b>Changing How the Effects Are Applied</b>  <b>OUTPUT LEVEL:</b> Changes the volume of the original sound.  <b>CHORUS SEND:</b> Changes the amount of chorus.  <b>REVERB SEND:</b> Changes the amount of reverb.</p> <p><b>Applying LFO to Modulate Sounds</b>  <b>LFO1/LFO2 PCH DEPTH:</b> Changes the vibrato depth.  <b>LFO1/LFO2 TVF DEPTH:</b> Changes the wah depth.  <b>LFO1/LFO2 TVA DEPTH:</b> Changes the tremolo depth.  <b>LFO1/LFO2 PAN DEPTH:</b> Changes the effect that the LFO will have on pan.  <b>LFO1/LFO2 RATE:</b> Changes the speed of the LFO cycles. The speed will not change if LFO Rate is set to <b>"note."</b></p> <p><b>Changing the Pitch Envelope</b>  <b>PIT ENV A-TIME:</b> Changes the Env Time 1 of the pitch envelope.  <b>PIT ENV D-TIME:</b> Changes the Env Time 2 and Env Time 3 of the pitch envelope.  <b>PIT ENV R-TIME:</b> Changes the Env Time 4 of the pitch envelope.</p> <p><b>Changing the TVF Envelope</b>  <b>TVF ENV A-TIME:</b> Changes the Env Time 1 of the TVF envelope.  <b>TVF ENV D-TIME:</b> Changes the Env Time 2 and Env Time 3 of the TVF envelope.  <b>TVF ENV R-TIME:</b> Changes the Env Time 4 of the TVF envelope.</p> <p><b>Changing the TVA Envelope</b>  <b>TVA ENV A-TIME:</b> Changes the Env Time 1 of the TVA envelope.  <b>TVA ENV D-TIME:</b> Changes the Env Time 2 and Env Time 3 of the TVA envelope.  <b>TVA ENV R-TIME:</b> Changes the Env Time 4 of the TVA envelope.</p> <p><b>Splitting Partial That Are Played</b>  <b>PMT:</b> If the Matrix Control is used to split partials, set the PMT Velocity Control (p. 48) to <b>"OFF,"</b> and the PMT Control Switch (p. 49) to <b>"ON."</b></p> <ul style="list-style-type: none"> <li>• If the Matrix Control is used to split partials, we recommend setting the Sens (p. 59) to <b>"+63."</b> Selecting a lower value may prevent switching of the partials. Furthermore, if you want to reverse the effect, set the value to <b>"-63."</b></li> <li>• If you want to use matrix control to switch smoothly between partials, use the Velo Fade Lower and Velo Fade Upper (p. 49). The higher the values set, the smoother the switch is between the partials.</li> </ul> <p><b>Changing the Depth of Frequency Modulation Produced by FXM</b>  <b>FXM DEPTH</b></p>
Control1-4 Sens1-4	-63+63	<p>Sets the amount of the Matrix Control's effect that is applied. If you wish to modify the selected parameter in a positive (+) direction – i.e., a higher value, toward the right, or faster etc. – from its current setting, select a positive (+) value. If you wish to modify the selected parameter in a negative (-) direction – i.e., a lower value, toward the left, or slower etc. – from its current setting, select a negative (-) value. For either positive or negative value, greater absolute values will allow greater amounts of change. Set this to <b>"0"</b> if you don't want to apply the effect.</p>
Control1-4 Switch1-4	OFF, ON, REVS	<p>Selects the partial to which the effect is applied when using the Matrix Control.</p> <p><b>OFF:</b> The effect will not be applied.  <b>ON:</b> The effect will be applied.  <b>REVS:</b> The effect will be applied in reverse.</p>

## PCM Synth Tone (PCMS)

Parameter	Value	Explanation
-----------	-------	-------------

### MFX tab

MFX Sw ( <b>[2]</b> MFX Sw button)	OFF, ON	Specifies whether the tone's multi-effect is used (ON) or not used (OFF).
MFX Type	0–68	Use this parameter to select from among the 68 available multi-effects. For details on multi-effects parameters, refer to <b>"MFX Parameters"</b> (p. 93).
Parameters for each MFX type	Edit the parameters for the selected MFX type.	
MFX Chorus Send Level	0–127	Adjusts the amount of chorus for the sound that passes through multi-effects. If you don't want to add the chorus effect, set it to <b>"0."</b>
MFX Reverb Send Level	0–127	Adjusts the amount of reverb for the sound that passes through multi-effects. If you don't want to add the reverb effect, set it to <b>"0."</b>

### MFX Control tab

Source (1–4)	OFF, CC01–31, 33–95, PITCH BEND, AFTERTOUCHE, SYS CTRL1–4	Sets the MIDI message used to change the multi-effects parameter with the multi-effects control. <b>OFF:</b> Multi-effects control will not be used. <b>CC01–31, 33–95:</b> Control Change <b>PITCH BEND:</b> Pitch Bend <b>AFTERTOUCHE:</b> Aftertouch <b>SYS CTRL1–4:</b> MIDI messages used as common multi-effects controls.
Destination (1–4)	Sets the multi-effects parameters to be controlled with the multi-effects control. The multi-effects parameters available for control will depend on the multi-effects type. For details, refer to <b>"Controlling a MFX via MIDI (MFX CONTROL)"</b> (p. 117).	
Sens (1–4)	-63–+63	Sets the amount of the multi-effects control's effect that is applied. To make an increase in the currently selected value (to get higher values, move to the right, increase rates, and so on), select a positive (+) value; to make a decrease in the currently selected value (to get lower values, move to the left, decrease rates, and so on), select a negative (-) value. For either positive or negative value, greater absolute values will allow greater amounts of change. Set this to <b>"0"</b> if you don't want to apply the effect.

# PCM Drum Kit (PCMD)

## TONE EDIT (PCMD)

Each kit has 88 sets (Partial 1–88) of WAVE, TVF, and TVA settings, in addition to multi-effect (MFX) settings.

Each partial has four wave generators. You can assign a different note number that will sound each of the 88 partials.

For the one part specified by the Drum Comp+EQ Assign setting, you'll be able to use six sets of compressor + equalizer units to make the sound more consistent or to adjust the tonal character.

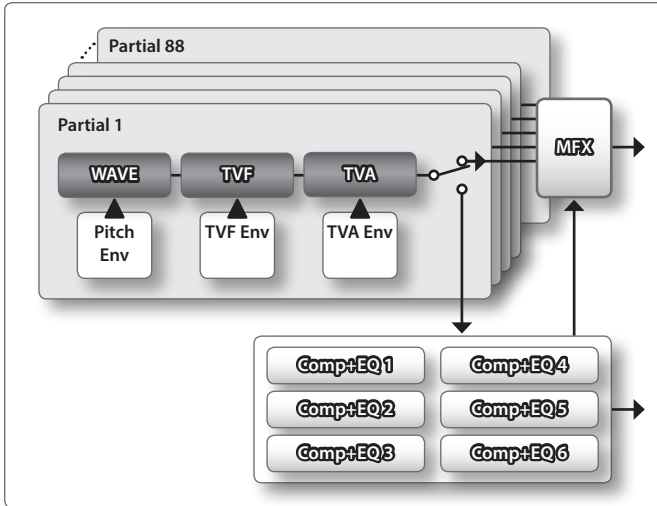

1. Select the part to which the tone is assigned.
2. Press the **[MENU]** button.
3. Move the cursor to **"Tone Edit"** and press the **[ENTER]** button.

Parameter	Value	Explanation
-----------	-------	-------------

### Common tab

#### MEMO

CURRENT PARTIAL (the currently selected partial) specifies the note number (21 (A0)–108 (C8)) to which you will assign a drum instrument.

Phrase Number	0–18	Number of the phrase that plays when you press the <b>[PREVIEW]</b> button.
Drum Kit Level	0–127	Sets the volume of the drum kit. <b>MEMO</b> The volume levels of the partials from which the drum kit is composed is set with the Partial Level parameter (p. 65). The volume levels of the Waves from which the drum partial is composed is set with the Wave Level parameter (p. 62).
Partial Name	12 characters	You can assign a name of up to 12 characters to the drum partial. By pressing <b>[ENTER]</b> , you can assign a name to the drum partial.
Assign Type	MULTI, SINGLE	Assign Type sets the way sounds are played when the same key is pressed a number of times. <b>MULTI:</b> Layer the sound of the same keys. Even with continuous sounds where the sound plays for an extended time, such as with crash cymbals, the sounds are layered, without previously played sounds being eliminated. <b>SINGLE:</b> Only one sound can be played at a time when the same key is pressed. With continuous sounds where the sound plays for an extended time, the previous sound is stopped when the following sound is played.
Mute Group	OFF, 1–31	On an actual acoustic drum set, an open hi-hat and a closed hi-hat sound can never occur simultaneously. To reproduce the reality of this situation, you can set up a Mute Group. The Mute Group function allows you to designate two or more drum partials that are not allowed to sound simultaneously. Up to 31 Mute Groups can be used. Drum partials that are not belong to any such group should be set to <b>"OFF"</b> .
Partial Env Mode	NO-SUS, SUSTAIN	When a loop waveform is selected, the sound will normally continue as long as the key is pressed. If you want the sound to decay naturally even if the key remains pressed, set this to <b>"NO-SUS"</b> . * If a one-shot type Wave is selected, it will not sustain even if this parameter is set to <b>"SUSTAIN."</b>
Partial Pitch Bend Range	0–48	Specifies the amount of pitch change in semitones (4 octaves) that will occur when the Pitch Bend Lever is moved. The amount of change when the lever is tilted is set to the same value for both left and right sides.
Partial Rx Expression	OFF, ON	For each drum partial, specify whether MIDI Expression messages will be received (ON), or not (OFF).

## PCM Drum Kit (PCMD)

Parameter	Value	Explanation
Partial Rx Hold-1	OFF, ON	For each drum partial, specify whether MIDI Hold-1 messages will be received (ON), or not (OFF).  <b>NOTE</b> If <b>"NO-SUS"</b> is selected for Partial Env Mode parameter (p. 61), this setting will have no effect.
One Shot Mode	OFF, ON	The sound will play back until the end of the waveform (or the end of the envelope, whichever comes first).  The result will be the same as when the envelope's Partial Env Mode parameter is set to <b>"NO-SUS."</b>

## Wave tab

Wave 1–4 Switch	OFF, ON	Turns the wave on/off.
Wave Group	INT, Ex01– (if expansion sound Waves exist)	Select the groups containing the Waves comprising the drum partial. <b>INT:</b> Internal sound bank <b>Ex01–:</b> Expansion sound banks
Wave No.L (Mono)	OFF, 1–	This selects the Waves comprising the drum partial. Along with the Wave number, the Wave name appears at the lower part of the display.
Wave No.R		When in monaural mode, only the left side (L) is specified. When in stereo, the right side (R) is also specified.
Wave Gain	-6, 0, +6, +12 dB	Sets the gain (amplification) of the waveform. The value changes in 6 dB (decibel) steps—an increase of 6 dB doubles the waveform's gain.
Wave Tempo Sync	OFF, ON	When you wish to synchronize a Phrase Loop to the clock (tempo), set this to <b>"ON."</b> This is available only if there are expansion sounds and you've selected a waveform that indicates the tempo (BPM). If a waveform of an expansion sound is selected for the partial, turning Wave Tempo Sync <b>"ON"</b> disables pitch-related settings and FXM-related settings.  <b>Phrase Loop</b> <b>"Phrase Loop"</b> refers to the repeated playback of a phrase that's been pulled out of a song (e.g., by using a sampler). One technique involving the use of Phrase Loops is the excerpting of a Phrase from a pre-existing song in a certain genre, for example dance music, and then creating a new song with that Phrase used as the basic motif. This is referred to as <b>"Break Beats."</b>
Wave FXM Switch	OFF, ON	This sets whether FXM will be used (ON) or not (OFF).  <b>FXM</b> FXM (Frequency Cross Modulation) uses a specified waveform to apply frequency modulation to the currently selected waveform, creating complex overtones. This is useful for creating dramatic sounds or sound effects.
Wave FXM Color	1–4	Specifies how FXM will perform frequency modulation. Higher settings result in a grainier sound, while lower settings result in a more metallic sound.
Wave FXM Depth	0–16	Specifies the depth of the modulation produced by FXM.  <b>NOTE</b> When the Wave Tempo Sync is set to <b>"ON,"</b> settings related to Pitch (p. 63) and FXM are disabled.
Wave Coarse Tune	-48–+48	Adjusts the pitch of the waveform's sound up or down in semitone steps (+/-4 octaves).  <b>MEMO</b> The Coarse Tune of the entire drum partial is set by the Partial Coarse Tune (p. 63).
Wave Fine Tune	-50–+50	Adjusts the pitch of the waveform's sound up or down in 1-cent steps (+/-50 cents). * One cent is 1/100th of a semitone.  <b>MEMO</b> The Fine Tune of the entire drum partial is set by the Partial Fine Tune (p. 63).
Wave Level	0–127	You can set the volume of the waveform.  <b>MEMO</b> The volume level of each drum partial is set with the Partial Level; the volume levels of the entire drum kit is set with the Drum Kit Level (p. 61).
Wave Pan	L64–63R	This specifies the pan of the waveform. <b>"L64"</b> is far left, <b>"0"</b> is center, and <b>"63R"</b> is far right.
Wave Random Pan Sw	OFF, ON	Use this setting to cause the waveform's panning to change randomly each time a key is pressed (ON) or not (OFF). * The range of the panning change is set by the Random Pan Depth (p. 66).
Wave Alter Pan Sw	OFF, ON, REVS	This setting causes panning of the waveform to be alternated between left and right each time a key is pressed. Set Alter Pan Sw to <b>"ON"</b> to pan the Wave according to the Alter Pan Depth settings, or to <b>"REVS"</b> when you want the panning reversed. If you do not want the panning to change each time a key is pressed, set this to <b>"OFF."</b>

Parameter	Value	Explanation
-----------	-------	-------------

### WMT tab

WMT Velocity Control	OFF, ON, RANDOM	WMT Velocity Control determines whether a different drum partial is played (ON) or not (OFF) depending on the force with which the key is played (velocity). When set to <b>"RANDOM,"</b> the drum kit's constituent drum partials will sound randomly, regardless of any velocity messages.
----------------------	-----------------	---

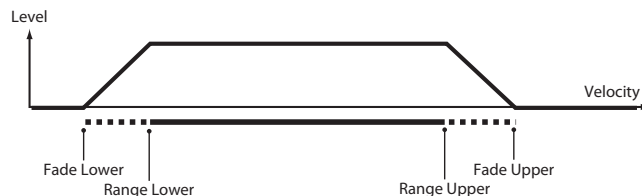

Velo Fade Upper	0-127	This determines what will happen to the tone's level when the tone is played at a velocity greater than its specified velocity range. Higher settings produce a more gradual change in volume. If you want notes played outside the specified key velocity range to not be sounded at all, set this to <b>"0."</b>
Velo Range Upper	LOWER-127	This sets the highest velocity at which the waveform will sound. Make these settings when you want different waveforms to sound in response to notes played at different strengths.
Velo Range Lower	1-UPPER	This sets the lowest velocity at which the waveform will sound. Make these settings when you want different waveforms to sound in response to notes played at different strengths. <b>NOTE</b> If you attempt to set the Lower velocity limit above the Upper, or the Upper below the Lower, the other value will automatically be adjusted to the same setting.
Velo Fade Lower	0-127	This determines what will happen to the tone's level when the tone is played at a velocity lower than its specified velocity range. Higher settings produce a more gradual change in volume. If you want notes played outside the specified key velocity range to not be sounded at all, set this to <b>"0."</b>

### Pitch tab

Partial Coarse Tune	C-1-G9	Selects the pitch at which a drum partial sounds. <b>MEMO</b> Set the coarse tuning for Waves comprising the drum partials with the Wave Coarse Tune parameter (p. 62).
Partial Fine Tune	-50+50	Adjusts the pitch of the drum partial's sound up or down in 1-cent steps (+/-50 cents). * One cent is 1/100th of a semitone. <b>MEMO</b> Set the fine tuning for Waves comprising the drum partials with the Wave Fine Tune parameter (p. 62).
Partial Random Pitch Depth	0, 1, 2, 3, 4, 5, 6, 7, 8, 9, 10, 20, 30, 40, 50, 60, 70, 80, 90, 100, 200, 300, 400, 500, 600, 700, 800, 900, 1000, 1100, 1200	This specifies the width of random pitch deviation that will occur each time a key is pressed. If you do not want the pitch to change randomly, set this to <b>"0."</b> These values are in units of cents (1/100th of a semitone).

### Pitch Env tab

Pitch Env Depth	-12+12	Adjusts the effect of the Pitch Envelope. Higher settings will cause the pitch envelope to produce greater change. Negative (-) value will invert the shape of the envelope.
Pitch Env V-Sens	-63+63	Keyboard playing dynamics can be used to control the depth of the pitch envelope. If you want the pitch envelope to have more effect for strongly played notes, set this parameter to a positive (+) value. If you want the pitch envelope to have less effect for strongly played notes, set this to a negative (-) value.
Pitch Env T1 V-Sens	-63+63	This allows keyboard dynamics to affect the Time 1 of the Pitch envelope. If you want Time 1 to be speeded up for strongly played notes, set this parameter to a positive (+) value. If you want it to be slowed down, set this to a negative (-) value.
Pitch Env T4 V-Sens	-63+63	Use this parameter when you want key release speed to affect the Time 4 value of the pitch envelope. If you want Time 4 to be speeded up for quickly released notes, set this parameter to a positive (+) value. If you want it to be slowed down, set this to a negative (-) value.
Pitch Env Time 1-4	0-127	Specify the pitch envelope times (Time 1-Time 4). Higher settings will result in a longer time until the next pitch is reached (For example, Time 2 is the time over which the pitch changes from Level 1 to Level 2.).

# PCM Drum Kit (PCMD)

Parameter	Value	Explanation
Pitch Env Level 0-4	-63~+63	<p>Specify the pitch envelope levels (Level 0~Level 4). It determines how much the pitch changes from the reference pitch (the value set with Coarse Tune or Fine Tune on the Pitch screen) at each point. Positive (+) value will cause the pitch to be higher than the standard pitch, and negative (-) value will cause it to be lower.</p> <p>T: Time L: Level</p>

## TVF tab

Filter Type	OFF, LPF, BPF, HPF, PKG, LPF2, LPF3	<p>Selects the type of filter. A filter cuts or boosts a specific frequency region to change a sound's brightness, thickness, or other qualities.</p> <p><b>OFF:</b> No filter is used.</p> <p><b>LPF:</b> Low Pass Filter. This reduces the volume of all frequencies above the cutoff frequency (Cutoff Freq) in order to round off, or un-brighten the sound. This is the most common filter used in synthesizers.</p> <p><b>BPF:</b> Band Pass Filter. This leaves only the frequencies in the region of the cutoff frequency (Cutoff Frequency), and cuts the rest. This can be useful when creating distinctive sounds.</p> <p><b>HPF:</b> High Pass Filter. This cuts the frequencies in the region below the cutoff frequency (Cutoff Frequency). This is suitable for creating percussive sounds emphasizing their higher ones.</p> <p><b>PKG:</b> Peaking Filter. This emphasizes the frequencies in the region of the cutoff frequency (Cutoff Frequency). This can be used to portray the resonance peak of a drum.</p> <p><b>LPF2:</b> Low Pass Filter 2. Although frequency components above the Cutoff frequency (Cutoff Frequency) are cut, the sensitivity of this filter is half that of the LPF. This makes it a comparatively warmer low pass filter. This filter is good for use with simulated instrument sounds such as the acoustic piano.</p> <p><b>LPF3:</b> Low Pass Filter 3. Although frequency components above the Cutoff frequency (Cutoff Frequency) are cut, the sensitivity of this filter changes according to the Cutoff frequency. While this filter is also good for use with simulated acoustic instrument sounds, the nuance it exhibits differs from that of the LPF2, even with the same TVF Envelope settings.</p> <p><b>NOTE</b> If you set "LPF2" or "LPF3," the setting for the Resonance parameter will be ignored.</p>
Cutoff Frequency	0~127	<p>Selects the frequency at which the filter begins to have an effect on the waveform's frequency components.</p> <p>With "LPF/LPF2/LPF3" selected for the Filter Type parameter, lower cutoff frequency settings reduce a tone's upper harmonics for a more rounded, warmer sound. Higher settings make it sound brighter.</p> <p>If "BPF" is selected, harmonic components will change depending on the TVF Cutoff Frequency setting. This can be useful when creating distinctive sounds.</p> <p>With "HPF" selected, higher Cutoff Frequency settings will reduce lower harmonics to emphasize just the brighter components of the sound.</p> <p>With "PKG" selected, the harmonics to be emphasized will vary depending on Cutoff Frequency setting.</p>
Resonance	0~127	<p>Emphasizes the portion of the sound in the region of the cutoff frequency, adding character to the sound. Excessively high settings can produce oscillation, causing the sound to distort.</p>

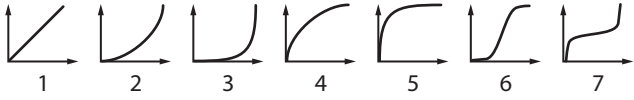

Parameter	Value	Explanation
Cutoff V-Curve	FIXED, 1-7	Selects one of the following seven curves that determine how keyboard playing dynamics (velocity) influence the cutoff frequency. Set this to "FIXED" if you don't want the Cutoff frequency to be affected by the keyboard velocity. 
Cutoff V-Sens	-63--+63	Use this parameter when changing the cutoff frequency to be applied as a result of changes in playing velocity. If you want strongly played notes to raise the cutoff frequency, set this parameter to positive (+) value. If you want strongly played notes to lower the cutoff frequency, use negative (-) value.
Resonance V-Sens	-63--+63	This allows keyboard velocity to modify the amount of Resonance. If you want strongly played notes to have a greater Resonance effect, set this parameter to positive (+) value. If you want strongly played notes to have less Resonance, use negative (-) value.
TVF Env V-Curve	FIXED, 1-7	Selects one of the following 7 curves that will determine how keyboard playing dynamics will affect the TVF envelope. Set this to "FIXED" if you don't want the TVF Envelope to be affected by the keyboard velocity. 
TVF Env V-Sens	-63--+63	Specifies how keyboard playing dynamics will affect the depth of the TVF envelope. Positive (+) value will cause the TVF envelope to have a greater effect for strongly played notes, and negative (-) settings will cause the effect to be less.
TVF Env T1 V-Sens	-63--+63	This allows keyboard dynamics to affect the Time 1 of the TVF envelope. If you want Time 1 to be speeded up for strongly played notes, set this parameter to a positive (+) value. If you want it to be slowed down, set this to a negative (-) value.
TVF Env T4 V-Sens	-63--+63	The parameter to use when you want key release speed to control the Time 4 value of the TVF envelope. If you want Time 4 to be speeded up for quickly released notes, set this parameter to a positive (+) value. If you want it to be slowed down, set this to a negative (-) value.

### TVF Env tab

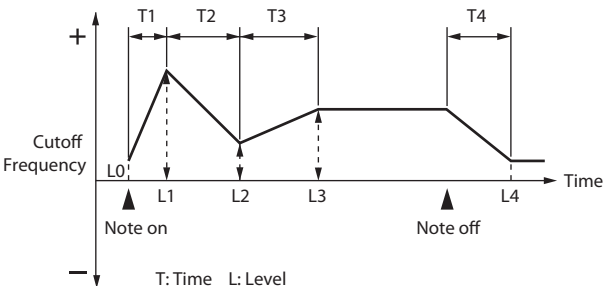
TVF Env Depth	-63--+63	Specifies the depth of the TVF envelope. Higher settings will cause the TVF envelope to produce greater change. Negative (-) value will invert the shape of the envelope.
TVF Env Time 1-4	0-127	Specify the TVF envelope times (Time 1-Time 4). Higher settings will lengthen the time until the next cutoff frequency level is reached (For example, Time 2 is the time over which Level 1 will change to Level 2).
TVF Env Level 0-4	0-127	Specify the TVF envelope levels (Level 0-Level 4). These settings specify how the cutoff frequency will change at each point, relative to the standard cutoff frequency (the cutoff frequency value specified in the TVF screen). 

### TVA tab

Partial Level	0-127	Sets the volume of the drum partial. Use this parameter to adjust the volume balance between drum partials. <b>MEMO</b> The volume levels of the Waves from which the drum partial is composed is set with the Wave Level parameter (p. 62).
Level V-Curve	FIXED, 1-7	You can select from seven curves that determine how keyboard playing strength will affect the volume. If you do not want the volume of the drum partial to be affected by the force with which you press the key, select "FIXED." 

## PCM Drum Kit (PCMD)

Parameter	Value	Explanation
Level V-Sens	-63~+63	Set this when you want the volume of the drum partial to change depending on the force with which you press the keys. Set this to a positive (+) value to have the changes in drum partial volume increase the more forcefully the keys are played; to make the tone play more softly as you play harder, set this to a negative (-) value.
Partial Pan	L64~63R	Sets the pan for the drum partial. "L64" is far left, "0" is center, and "63R" is far right. <b>MEMO</b> Set the Pan for Waves comprising the drum partials with the Wave Pan parameter (p. 62).
Random Pan Depth	0~63	Use this parameter when you want the stereo location to change randomly each time you press a key. Higher settings will produce a greater amount of change. <b>NOTE</b> This will affect only waves whose Wave Random Pan Sw parameter (p. 62) is ON.
Alternate Pan Depth	L63~63R	This setting causes panning to be alternated between left and right each time a key is pressed. Higher settings will produce a greater amount of change. "L" or "R" settings will reverse the order in which the pan will alternate between left and right. For example if two drum partials are set to "L" and "R" respectively, the panning of the two drum partials will alternate each time they are played. <b>NOTE</b> This will affect only waves whose Wave Alter Pan Sw parameter (p. 62) is ON or REVS.
Relative Level	-64~+63	Corrects for the volume of the drum partial. This parameter is set by the key-based controller system exclusive message. Normally, you should leave it set to 0. <b>NOTE</b> If the drum partial level is set to 127, the volume will not increase beyond that point.

## TVA Env tab

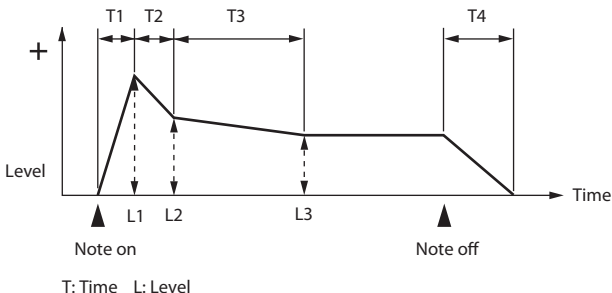
TVA Env T1 V-Sens	-63~+63	This allows keyboard dynamics to affect the Time 1 of the TVA envelope. If you want Time 1 to be speeded up for strongly played notes, set this parameter to a positive (+) value. If you want it to be slowed down, set this to a negative (-) value.
TVA Env T4 V-Sens	-63~+63	The parameter to use when you want key release speed to control the Time 4 value of the TVA envelope. If you want Time 4 to be speeded up for quickly released notes, set this parameter to a positive (+) value. If you want it to be slowed down, set this to a negative (-) value.
TVA Env Time 1~4	0~127	Specify the TVA envelope times (Time 1~Time 4). Higher settings will lengthen the time until the next volume level is reached (For example, Time 2 is the time over which Level 1 will change to Level 2.).
TVA Env Level 1~3	0~127	Specify the TVA envelope levels (Level 1~Level 3). These settings specify how the volume will change at each point, relative to the standard volume (the Partial Level value specified in the TVA screen).  T: Time L: Level

## Output tab

Partial Output Assign	PART, COMP+EQ1~6	Specifies how the sound of each partial will be output.
Partial Output Level	0~127	Specifies the signal level of each partial.
Partial Chorus Send Level	0~127	Specifies the level of the signal sent to the chorus for each partial.
Partial Reverb Send Level	0~127	Specifies the level of the signal sent to the reverb for each partial.

## Comp tab

\* COMP+EQ can be used only for the part specified by Drum Comp+EQ Assign.

Comp 1~6 Switch	OFF, ON	Compressor on/off
Comp 1~6 Attack Time	0.05~50.0 ms	Time from when the input exceeds the threshold until compression begins
Comp 1~6 Release Time	0.05~2000 ms	Time from when the input falls below the threshold until compression is turned off
Comp 1~6 Threshold	0~127	Level above which compression is applied
Comp 1~6 Ratio	1:1~inf:1	Compression ratio
Comp 1~6 Output Gain	0~+24 dB	Level of the output sound

Parameter	Value	Explanation
-----------	-------	-------------

## EQ tab

\* COMP + EQ can be used only for the part specified by the Drum Comp+EQ Assign setting.

EQ 1-6 Switch	OFF, ON	Equalizer on/off
EQ 1-6 Low Freq	200, 400 Hz	Frequency of the low range
EQ 1-6 Low Gain	-15→+15 dB	Gain of the low range
EQ 1-6 Mid Freq	200, 250, 315, 400, 500, 630, 800, 1000, 1250, 1600, 2000, 2500, 3150, 4000, 5000, 6300, 8000 Hz	Frequency of the middle range
EQ 1-6 Mid Gain	-15→+15 dB	Gain of the middle range
EQ 1-6 Mid Q	0.5, 1.0, 2.0, 4.0, 8.0	Width of the middle range Set a higher value for Q to narrow the range to be affected.
EQ 1-6 High Freq	2000, 4000, 8000 Hz	Frequency of the high range
EQ 1-6 High Gain	-15→+15 dB	Gain of the high range

## MFX tab

MFX Sw ( <b>[2]</b> (MFX Sw) button)	OFF, ON	Specifies whether the tone's multi-effect is used (ON) or not used (OFF).
MFX Type	0-68	Use this parameter to select from among the 68 available tone multi-effects. For details on tone multi-effects parameters, refer to " <b>MFX Parameters</b> " (p. 93).
Parameters for each MFX type	Edit the parameters for the selected MFX type.	
MFX Chorus Send Level	0-127	Adjusts the amount of chorus for the sound that passes through multi-effects. If you don't want to add the chorus effect, set it to " <b>0</b> ."
MFX Reverb Send Level	0-127	Adjusts the amount of reverb for the sound that passes through multi-effects. If you don't want to add the reverb effect, set it to " <b>0</b> ."

## MFX Control tab

Source (1-4)	OFF, CC01-31, 33-95, PITCH BEND, AFTERTOUCHE, SYS CTRL1-4	Sets the MIDI message used to change the multi-effects parameter with the multi-effects control. <b>OFF</b> : Multi-effects control will not be used. <b>CC01-31, 33-95</b> : Control Change <b>PITCH BEND</b> : Pitch Bend <b>AFTERTOUCHE</b> : Aftertouch <b>SYS CTRL1-4</b> : MIDI messages used as common multi-effects controls.
Destination (1-4)	Sets the multi-effects parameters to be controlled with the multi-effects control. The multi-effects parameters available for control will depend on the multi-effects type. For details, refer to " <b>Controlling a MFX via MIDI (MFX CONTROL)</b> " (p. 117).	
Sens (1-4)	-63→+63	Sets the amount of the multi-effects control's effect that is applied. To make an increase in the currently selected value (to get higher values, move to the right, increase rates, and so on), select a positive (+) value; to make a decrease in the currently selected value (to get lower values, move to the left, decrease rates, and so on), select a negative (-) value. For either positive or negative value, greater absolute values will allow greater amounts of change. Set this to " <b>0</b> " if you don't want to apply the effect.

# Chorus, Reverb

## Chorus Parameters

The chorus section can be used as a delay.

Select either chorus or delay, and specify how the chorus/delay sound will be heard.

Parameter	Value	Explanation
Chorus Type	00: OFF, 01: Chorus, 02: Delay, 03: GM2 Chorus	Selects either Chorus or Delay. <b>OFF:</b> Neither Chorus or Delay is used. <b>Chorus:</b> Chorus is used. <b>Delay:</b> Delay is used. <b>GM2:</b> GM2 Chorus is used.
Chorus Level	0–127	Volume of the chorus sound
Chorus Output Assign	MAIN, SUB	Selects the pair of OUTPUT jacks to which the chorus sound is routed when Chorus Output Select is set to <b>"MAIN"</b> or <b>"MAIN+REV"</b>
Chorus Output Select	MAIN, REV, MAIN+REV	Specifies how the sound routed through chorus will be output. <b>MAIN:</b> Output to the OUTPUT jacks. <b>REV:</b> Output to the reverb. <b>MAIN+REV:</b> Output to the OUTPUT jacks, and the reverb.
<b>01: Chorus</b>		
Filter Type	OFF, LPF, HPF	Type of filter <b>OFF:</b> No filter is used. <b>LPF:</b> Cuts the frequency range above the Cutoff Freq <b>HPF:</b> Cuts the frequency range below the Cutoff Freq
Cutoff Freq	200–8000 Hz	Basic frequency of the filter
Pre Delay	0.0–100 msec	Adjusts the delay time from the direct sound until the chorus sound is heard.
Rate	0.05–10.00 Hz, note	Frequency of modulation
Depth	0–127	Depth of modulation
Phase	0–180 deg	Spatial spread of the sound
Feedback	0–127	Adjusts the amount of the chorus sound that is fed back into the effect.
<b>02: Delay</b>		
Delay Left	0–1000 msec, note	Adjusts the delay time from the direct sound until the delay sound is heard.
Delay Right		
Delay Center		
Center Feedback	-98→+98 %	Adjusts the proportion of the delay sound that is fed back into the effect. Negative (-) value will invert the phase.
HF Damp	200–8000 Hz, BYPASS	Adjusts the frequency above which sound fed back to the effect will be cut. If you do not want to cut the high frequencies, set this parameter to BYPASS.
Left Level	0–127	Volume of each delay sound
Right Level		
Center Level		
<b>03: GM2 Chorus</b>		
Pre-LPF	0–7	Cuts the high frequency range of the sound coming into the chorus. Higher values will cut more of the high frequencies.
Level	0–127	Volume of the chorus sound
Feedback	0–127	Adjusts the amount of the chorus sound that is fed back into the effect.
Delay	0–127	Adjusts the delay time from the direct sound until the chorus sound is heard.
Rate	0–127	Frequency of modulation
Depth	0–127	Depth of modulation
Send Level to Reverb	0–127	Adjusts the amount of chorus sound that will be sent to the reverb.

## Reverb Parameters

Parameter	Value	Explanation		
Reverb Type	00: OFF 01: Room 1 02: Room 2 03: Hall 1 04: Hall 2 05: Plate 06: GM2 Reverb	Type of reverb <b>OFF:</b> Reverb will not be used <b>Room 1/2:</b> Reverb that simulates the reverberation of a room <b>Hall 1/2:</b> Reverb that simulates the reverberation of a hall <b>Plate:</b> Simulation of a plate echo (a reverb device that uses a metal plate) <b>GM2 Reverb:</b> GM2 reverb		
		Reverb Level	0–127	Volume of the reverb sound
		Reverb Output Assign	MAIN, SUB	Specifies how the sound routed through reverb will be output.
		<b>01–05: Room 1/2, Hall 1/2, Plate</b>		
		Pre Delay	0–100 msec	Adjusts the delay time from the direct sound until the reverb sound is heard.
		Time	0.1–10 sec	Time length of reverberation
		Density	0–127	Density of reverb
Diffusion	0–127	Adjusts the change in the density of the reverb over time. The higher the value, the more the density increases with time. (The effect of this setting is most pronounced with long reverb times.)		
		LF Damp	0–100	Adjusts the low-frequency portion of the reverb.
HF Damp	0–100	Adjusts the high-frequency portion of the reverb.		
Spread	0–127	Reverb spread		
Tone	0–127	Tonal character of the reverb		
<b>06: GM2 Reverb</b>				
Character	0–5	Type of reverb		
Time	0–127	Time length of reverberation		

# IFX Parameters

The IFX features 78 different kinds of effects. Some of the effects consist of two or more different effects connected in series.

Type	IFX Name	Page
	00 Thru	–
FILTER	01 Equalizer	p. 70
	02 Spectrum	p. 70
	03 Isolator	p. 70
	04 Low Boost	p. 70
	05 Super Filter	p. 71
	06 Step Filter	p. 71
	07 Enhancer	p. 71
	08 Auto Wah	p. 72
	09 Humanizer	p. 72
	10 Speaker Simulator	p. 72
MODULATION	11 Phaser	p. 73
	12 Step Phaser	p. 73
	13 Multi Stage Phaser	p. 73
	14 Infinite Phaser	p. 73
	15 Ring Modulator	p. 74
	16 Step Ring Modulator	p. 74
	17 Tremolo	p. 74
	18 Auto Pan	p. 74
	19 Step Pan	p. 75
	20 Slicer	p. 75
	21 Rotary	p. 75
	22 VK Rotary	p. 76
CHORUS	23 Chorus	p. 76
	24 Flanger	p. 76
	25 Step Flanger	p. 77
	26 Hexa-Chorus	p. 77
	27 Tremolo Chorus	p. 77
	28 Space-D	p. 77
	29 3D Chorus	p. 78
	30 3D Flanger	p. 78
	31 3D Step Flanger	p. 78
	32 2Band Chorus	p. 79
	33 2Band Flanger	p. 79
	34 2Band Step Flanger	p. 79
DYNAMICS	35 Overdrive	p. 80
	36 Distortion	p. 80
	37 VS Overdrive	p. 80
	38 VS Distortion	p. 80
	39 Guitar Amp Simulator	p. 80
	40 Compressor	p. 81
	41 Limiter	p. 81
	42 Gate	p. 81

Type	IFX Name	Page	
DELAY	43 Delay	p. 81	
	44 Long Delay	p. 82	
	45 Serial Delay	p. 82	
	46 Modulation Delay	p. 82	
	47 3Tap Pan Delay	p. 83	
	48 4Tap Pan Delay	p. 83	
	49 Multi Tap Delay	p. 83	
	50 Reverse Delay	p. 84	
	51 Shuffle Delay	p. 84	
	52 3D Delay	p. 84	
	53 Time Ctrl Delay	p. 85	
	54 Long Time Ctrl Delay	p. 85	
	55 Tape Echo	p. 85	
	LO-FI	56 Lofi Noise	p. 86
		57 Lofi Compress	p. 86
58 Lofi Radio		p. 86	
59 Telephone		p. 87	
60 Phonograph		p. 87	
61 Pitch Shifter		p. 87	
PITCH	62 2Voice Pitch Shifter	p. 87	
	63 Step Pitch Shifter	p. 88	
	64 Reverb	p. 88	
REVERB	65 Gated Reverb	p. 88	
	66 Overdrive → Chorus	p. 89	
COMBINATION	67 Overdrive → Flanger	p. 89	
	68 Overdrive → Delay	p. 89	
	69 Distortion → Chorus	p. 89	
	70 Distortion → Flanger	p. 89	
	71 Distortion → Delay	p. 90	
	72 Enhancer → Chorus	p. 90	
	73 Enhancer → Flanger	p. 90	
	74 Enhancer → Delay	p. 90	
	75 Chorus → Delay	p. 90	
	76 Flanger → Delay	p. 91	
	77 Chorus → Flanger	p. 91	
	PIANO	78 Sympathetic Resonance	p. 91

# IFX Parameters

## 01: Equalizer

This is a four-band stereo equalizer (low, mid x 2, high).

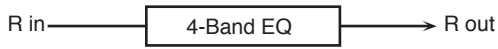
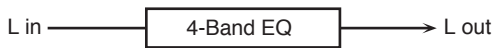

Parameter	Value	Explanation
Low Freq	200, 400 Hz	Frequency of the low range
Low Gain	-15--+15 dB	Gain of the low range
Mid1 Freq	200-8000 Hz	Frequency of the middle range 1
Mid1 Gain	-15--+15 dB	Gain of the middle range 1
Mid1 Q	0.5, 1.0, 2.0, 4.0, 8.0	Width of the middle range 1 Set a higher value for Q to narrow the range to be affected.
Mid2 Freq	200-8000 Hz	Frequency of the middle range 2
Mid2 Gain	-15--+15 dB	Gain of the middle range 2
Mid2 Q	0.5, 1.0, 2.0, 4.0, 8.0	Width of the middle range 2 Set a higher value for Q to narrow the range to be affected.
High Freq	2000, 4000, 8000 Hz	Frequency of the high range
High Gain	-15--+15 dB	Gain of the high range
Level	0-127	Output Level

## 02: Spectrum

This is a stereo spectrum. Spectrum is a type of filter which modifies the timbre by boosting or cutting the level at specific frequencies.

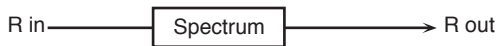

Parameter	Value	Explanation
Band1 (250 Hz)	-15--+15 dB	Gain of each frequency band
Band2 (500 Hz)		
Band3 (1000 Hz)		
Band4 (1250 Hz)		
Band5 (2000 Hz)		
Band6 (3150 Hz)		
Band7 (4000 Hz)		
Band8 (8000 Hz)		
Q	0.5, 1.0, 2.0, 4.0, 8.0	Simultaneously adjusts the width of the adjusted ranges for all the frequency bands.
Level	0-127	Output Level

## 03: Isolator

This is an equalizer which cuts the volume greatly, allowing you to add a special effect to the sound by cutting the volume in varying ranges.



Parameter	Value	Explanation
Boost/Cut Low	-60--+4 dB	These boost and cut each of the High, Middle, and Low frequency ranges. At -60 dB, the sound becomes inaudible. 0 dB is equivalent to the input level of the sound.
Boost/Cut Mid		
Boost/Cut High		
Anti Phase Low Sw	OFF, ON	Turns the Anti-Phase function on and off for the Low frequency ranges. When turned on, the counter-channel of stereo sound is inverted and added to the signal.
Anti Phase Low Level	0-127	Adjusts the level settings for the Low frequency ranges. Adjusting this level for certain frequencies allows you to lend emphasis to specific parts (This is effective only for stereo source.).
Anti Phase Mid Sw	OFF, ON	Settings of the Anti-Phase function for the Middle frequency ranges.
Anti Phase Mid Level	0-127	The parameters are the same as for the Low frequency ranges.
Low Boost Sw	OFF, ON	Turns Low Booster on/off. This emphasizes the bottom to create a heavy bass sound.
Low Boost Level	0-127	Increasing this value gives you a heavier low end. * Depending on the Isolator and filter settings this effect may be hard to distinguish.
Level	0-127	Output Level

## 04: Low Boost

Boosts the volume of the lower range, creating powerful lows.

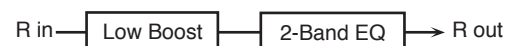

Parameter	Value	Explanation
Boost Frequency	50-125 Hz	Center frequency at which the lower range will be boosted
Boost Gain	0--+12 dB	Amount by which the lower range will be boosted
Boost Width	WIDE, MID, NARROW	Width of the lower range that will be boosted
Low Gain	-15--+15 dB	Gain of the low frequency range
High Gain	-15--+15 dB	Gain of the high frequency range
Level	0-127	Output level

### 05: Super Filter

This is a filter with an extremely sharp slope. The cutoff frequency can be varied cyclically.

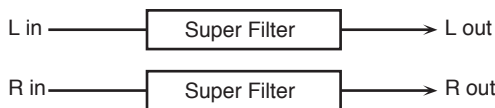

Parameter	Value	Explanation
Filter Type	Filter type Frequency range that will pass through each filter	
	LPF	Frequencies below the cutoff
	BPF	Frequencies in the region of the cutoff
	HPF	Frequencies above the cutoff
	NOTCH	Frequencies other than the region of the cutoff
Filter Slope	Amount of attenuation per octave	
	-12 dB	Gentle
	-24 dB	Steep
	-36 dB	Extremely steep
Filter Cutoff	0-127	Cutoff frequency of the filter Increasing this value will raise the cutoff frequency.
Filter Resonance	0-127	Filter resonance level Increasing this value will emphasize the region near the cutoff frequency.
Filter Gain	0-+12 dB	Amount of boost for the filter output
Modulation Sw	OFF, ON	On/off switch for cyclic change
Modulation Wave	How the cutoff frequency will be modulated	
	TRI	Triangle wave
	SQR	Square wave
	SIN	Sine wave
	SAW1	Sawtooth wave (upward)
	SAW2	Sawtooth wave (downward)
Rate	0.05-10.00 Hz, note	Rate of modulation
Depth	0-127	Depth of modulation
Attack	0-127	Speed at which the cutoff frequency will change This is effective if Modulation Wave is SQR, SAW1, or SAW2.
Level	0-127	Output level

### 06: Step Filter

This is a filter whose cutoff frequency can be modulated in steps. You can specify the pattern by which the cutoff frequency will change.



Parameter	Value	Explanation
Step 01-16	0-127	Cutoff frequency at each step
Rate	0.05-10.00 Hz, note	Rate of modulation
Attack	0-127	Speed at which the cutoff frequency changes between steps
Filter Type	Filter type Frequency range that will pass through each filter	
	LPF	Frequencies below the cutoff
	BPF	Frequencies in the region of the cutoff
	HPF	Frequencies above the cutoff
	NOTCH	Frequencies other than the region of the cutoff
Filter Slope	Amount of attenuation per octave	
	-12 dB	Gentle
	-24 dB	Steep
	-36 dB	Extremely steep
Filter Resonance	0-127	Filter resonance level Increasing this value will emphasize the region near the cutoff frequency.
Filter Gain	0-+12 dB	Amount of boost for the filter output
Level	0-127	Output level

### 07: Enhancer

Controls the overtone structure of the high frequencies, adding sparkle and tightness to the sound.

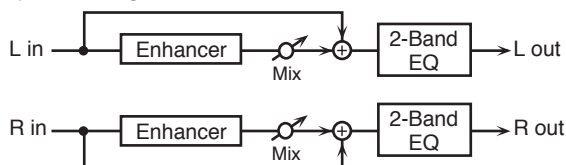

Parameter	Value	Explanation
Sens	0-127	Sensitivity of the enhancer
Mix	0-127	Level of the overtones generated by the enhancer
Low Gain	-15-+15 dB	Gain of the low range
High Gain	-15-+15 dB	Gain of the high range
Level	0-127	Output Level

# IFX Parameters

## 08: Auto Wah

Cyclically controls a filter to create cyclic change in timbre.

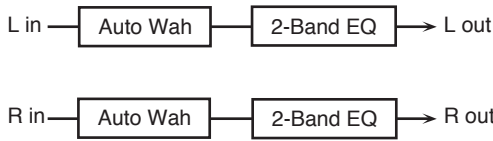

Parameter	Value	Explanation
Filter Type	Type of filter	
	LPF	The wah effect will be applied over a wide frequency range.
	BPF	The wah effect will be applied over a narrow frequency range.
Manual	0-127	Adjusts the center frequency at which the effect is applied.
Peak	0-127	Adjusts the amount of the wah effect that will occur in the range of the center frequency. Set a higher value for Q to narrow the range to be affected.
Sens	0-127	Adjusts the sensitivity with which the filter is controlled.
Polarity	Sets the direction in which the frequency will change when the auto-wah filter is modulated.	
	UP	The filter will change toward a higher frequency.
	DOWN	The filter will change toward a lower frequency.
Rate	0.05-10.00 Hz, note	Frequency of modulation
Depth	0-127	Depth of modulation
Phase	0-180 deg	Adjusts the degree of phase shift of the left and right sounds when the wah effect is applied.
Low Gain	-15-+15 dB	Gain of the low range
High Gain	-15-+15 dB	Gain of the high range
Level	0-127	Output Level

Parameter	Value	Explanation
Manual	Point at which Vowel 1/2 switch	
	0-49	Vowel 1 will have a longer duration.
	50	Vowel 1 and 2 will be of equal duration.
	51-100	Vowel 2 will have a longer duration.
Low Gain	-15-+15 dB	Gain of the low frequency range
High Gain	-15-+15 dB	Gain of the high frequency range
Pan	L64-63R	Stereo location of the output
Level	0-127	Output level

## 10: Speaker Simulator

Simulates the speaker type and microphone settings used to record the speaker sound.

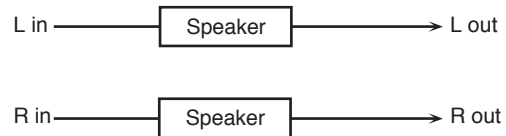

Parameter	Value	Explanation
Speaker Type	(See the following table)	Type of speaker
Mic Setting	1, 2, 3	Adjusts the location of the microphone that is recording the sound of the speaker. This can be adjusted in three steps, with the microphone becoming more distant in the order of 1, 2, and 3.
Mic Level	0-127	Volume of the microphone
Direct Level	0-127	Volume of the direct sound
Level	0-127	Output Level

### Specifications of each Speaker Type

The speaker column indicates the diameter of each speaker unit (in inches) and the number of units.

Type	Cabinet	Speaker	Microphone
SMALL 1	Small open-back enclosure	10	Dynamic
SMALL 2	Small open-back enclosure	10	Dynamic
MIDDLE	Open back enclosure	12 x 1	Dynamic
JC-120	Open back enclosure	12 x 2	Dynamic
BUILT-IN 1	Open back enclosure	12 x 2	Dynamic
BUILT-IN 2	Open back enclosure	12 x 2	Condenser
BUILT-IN 3	Open back enclosure	12 x 2	Condenser
BUILT-IN 4	Open back enclosure	12 x 2	Condenser
BUILT-IN 5	Open back enclosure	12 x 2	Condenser
BG STACK 1	Sealed enclosure	12 x 2	Condenser
BG STACK 2	Large sealed enclosure	12 x 2	Condenser
MS STACK 1	Large sealed enclosure	12 x 4	Condenser
MS STACK 2	Large sealed enclosure	12 x 4	Condenser
METAL STACK	Large double stack	12 x 4	Condenser
2-STACK	Large double stack	12 x 4	Condenser
3-STACK	Large triple stack	12 x 4	Condenser

## 09: Humanizer

Adds a vowel character to the sound, making it similar to a human voice.

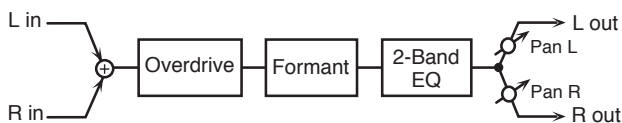

Parameter	Value	Explanation
Drive Sw	OFF, ON	Turns Drive on/off.
Drive	0-127	Degree of distortion Also changes the volume.
Vowel1	a, e, i, o, u	Selects the vowel.
Vowel2	a, e, i, o, u	
Rate	0.05-10.00 Hz, note	Frequency at which the two vowels switch
Depth	0-127	Effect depth
Input Sync Sw	OFF, ON	LFO reset on/off Determines whether the LFO for switching the vowels is reset by the input signal (ON) or not (OFF).
Input Sync Threshold	0-127	Volume level at which reset is applied



### 11: Phaser

This is a stereo phaser. A phase-shifted sound is added to the original sound and modulated.

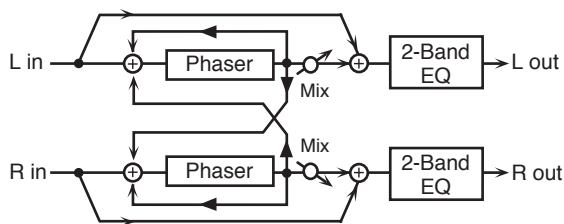

Parameter	Value	Explanation
Mode	4-STAGE, 8-STAGE, 12-STAGE	Number of stages in the phaser
Manual	0–127	Adjusts the basic frequency from which the sound will be modulated.
Rate	0.05–10.00 Hz, note	Frequency of modulation
Depth	0–127	Depth of modulation
Polarity	Selects whether the left and right phase of the modulation will be the same or the opposite.	
	INVERSE	The left and right phase will be opposite. When using a mono source, this spreads the sound.
SYNCHRO	The left and right phase will be the same. Select this when inputting a stereo source.	
Resonance	0–127	Amount of feedback
Cross Feedback	-98–+98 %	Adjusts the proportion of the phaser sound that is fed back into the effect. Negative (-) settings will invert the phase.
Mix	0–127	Level of the phase-shifted sound
Low Gain	-15–+15 dB	Gain of the low range
High Gain	-15–+15 dB	Gain of the high range
Level	0–127	Output Level

### 12: Step Phaser

This is a stereo phaser. The phaser effect will be varied gradually.

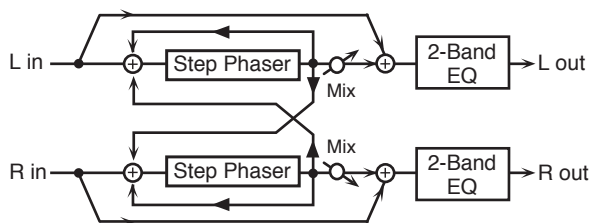

Parameter	Value	Explanation
Mode	4-STAGE, 8-STAGE, 12-STAGE	Number of stages in the phaser
Manual	0–127	Adjusts the basic frequency from which the sound will be modulated.
Rate	0.05–10.00 Hz, note	Frequency of modulation
Depth	0–127	Depth of modulation
Polarity	Selects whether the left and right phase of the modulation will be the same or the opposite.	
	INVERSE	The left and right phase will be opposite. When using a mono source, this spreads the sound.
SYNCHRO	The left and right phase will be the same. Select this when inputting a stereo source.	

Parameter	Value	Explanation
Resonance	0–127	Amount of feedback
Cross Feedback	-98–+98 %	Adjusts the proportion of the phaser sound that is fed back into the effect. Negative (-) settings will invert the phase.
Step Rate	0.10–20.00 Hz, note	Rate of the step-wise change in the phaser effect
Mix	0–127	Level of the phase-shifted sound
Low Gain	-15–+15 dB	Gain of the low range
High Gain	-15–+15 dB	Gain of the high range
Level	0–127	Output Level

### 13: Multi Stage Phaser

Extremely high settings of the phase difference produce a deep phaser effect.

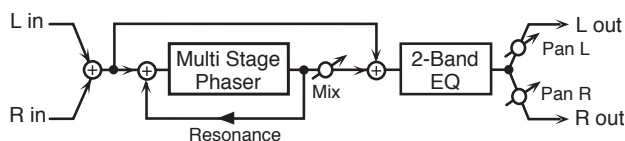

Parameter	Value	Explanation
Mode	4-STAGE, 8-STAGE, 12-STAGE, 16-STAGE, 20-STAGE, 24-STAGE	Number of phaser stages
Manual	0–127	Adjusts the basic frequency from which the sound will be modulated.
Rate	0.05–10.00 Hz, note	Frequency of modulation
Depth	0–127	Depth of modulation
Resonance	0–127	Amount of feedback
Mix	0–127	Level of the phase-shifted sound
Pan	L64–63R	Stereo location of the output sound
Low Gain	-15–+15 dB	Gain of the low range
High Gain	-15–+15 dB	Gain of the high range
Level	0–127	Output Level

### 14: Infinite Phaser

A phaser that continues raising/lowering the frequency at which the sound is modulated.

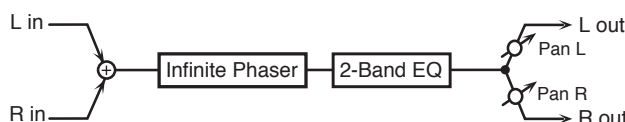

Parameter	Value	Explanation
Mode	1, 2, 3, 4	Higher values will produce a deeper phaser effect.
Speed	-100–+100	Speed at which to raise or lower the frequency at which the sound is modulated (+: upward / -: downward)
Resonance	0–127	Amount of feedback
Mix	0–127	Volume of the phase-shifted sound
Pan	L64–63R	Panning of the output sound
Low Gain	-15–+15 dB	Amount of boost/cut for the low-frequency range
High Gain	-15–+15 dB	Amount of boost/cut for the high-frequency range
Level	0–127	Output volume

## 15: Ring Modulator

This is an effect that applies amplitude modulation (AM) to the input signal, producing bell-like sounds. You can also change the modulation frequency in response to changes in the volume of the sound sent into the effect.

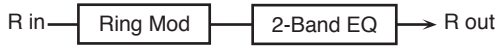

Parameter	Value	Explanation
Frequency	0-127	Adjusts the frequency at which modulation is applied.
Sens	0-127	Adjusts the amount of frequency modulation applied.
Polarity	Determines whether the frequency modulation moves towards higher frequencies or lower frequencies.	
	UP	Higher frequencies
	DOWN	Lower frequencies
Low Gain	-15+15 dB	Gain of the low frequency range
High Gain	-15+15 dB	Gain of the high frequency range
Balance	D100:0W-D0:100W	Volume balance between the direct sound (D) and the effect sound (W)
Level	0-127	Output level

## 16: Step Ring Modulator

This is a ring modulator that uses a 16-step sequence to vary the frequency at which modulation is applied.



Parameter	Value	Explanation
Step 01-16	0-127	Frequency of ring modulation at each step
Rate	0.05-10.00 Hz, note	Rate at which the 16-step sequence will cycle
Attack	0-127	Speed at which the modulation frequency changes between steps
Low Gain	-15+15 dB	Amount of boost/cut for the low-frequency range
High Gain	-15+15 dB	Amount of boost/cut for the high-frequency range
Balance	D100:0W-D0:100W	Volume balance of the original sound (D) and effect sound (W)
Level	0-127	Output volume

## 17: Tremolo

Cyclically modulates the volume to add tremolo effect to the sound.



Parameter	Value	Explanation
Mod Wave	Modulation Wave	
	TRI	Triangle wave
	SQR	Square wave
	SIN	Sine wave
	SAW1/2	Sawtooth wave
	SAW1	SAW2
Rate	0.05-10.00 Hz, note	Frequency of the change
Depth	0-127	Depth to which the effect is applied
Low Gain	-15+15 dB	Gain of the low range
High Gain	-15+15 dB	Gain of the high range
Level	0-127	Output Level

## 18: Auto Pan

Cyclically modulates the stereo location of the sound.



Parameter	Value	Explanation
Mod Wave	Modulation Wave	
	TRI	Triangle wave
	SQR	Square wave
	SIN	Sine wave
	SAW1/2	Sawtooth wave
	SAW1 R	SAW2 R
Rate	0.05-10.00 Hz, note	Frequency of the change
Depth	0-127	Depth to which the effect is applied
Low Gain	-15+15 dB	Gain of the low range
High Gain	-15+15 dB	Gain of the high range
Level	0-127	Output Level

### 19: Step Pan

This uses a 16-step sequence to vary the panning of the sound.

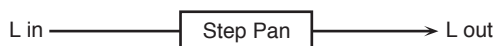

Parameter	Value	Explanation
Step 01-16	L64-63R	Pan at each step
Rate	0.05-10.00 Hz, note	Rate at which the 16-step sequence will cycle
Attack	0-127	Speed at which the pan changes between steps
Input Sync Sw	OFF, ON	Specifies whether an input note will cause the sequence to resume from the first step of the sequence (ON) or not (OFF)
Input Sync Threshold	0-127	Volume at which an input note will be detected
Level	0-127	Output volume

### 20: Slicer

By applying successive cuts to the sound, this effect turns a conventional sound into a sound that appears to be played as a backing phrase. This is especially effective when applied to sustain-type sounds.

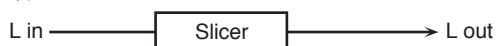

Parameter	Value	Explanation
Step 01-16	0-127	Level at each step
Rate	0.05-10.00 Hz, note	Rate at which the 16-step sequence will cycle
Attack	0-127	Speed at which the level changes between steps
Input Sync Sw	OFF, ON	Specifies whether an input note will cause the sequence to resume from the first step of the sequence (ON) or not (OFF)
Input Sync Threshold	0-127	Volume at which an input note will be detected
Mode	Sets the manner in which the volume changes as one step progresses to the next.	
	LEGATO	The change in volume from one step's level to the next remains unaltered. If the level of a following step is the same as the one preceding it, there is no change in volume.
	SLASH	The level is momentarily set to 0 before progressing to the level of the next step. This change in volume occurs even if the level of the following step is the same as the preceding step.
Shuffle	0-127	Timing of volume changes in levels for even-numbered steps (step 2, step 4, step 6...). The higher the value, the later the beat progresses.
Level	0-127	Output level

### 21: Rotary

The Rotary effect simulates the sound of the rotary speakers often used with the electric organs of the past. Since the movement of the high range and low range rotors can be set independently, the unique type of modulation characteristic of these speakers can be simulated quite closely. This effect is most suitable for electric organ Tones.

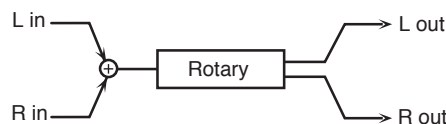

Parameter	Value	Explanation
Speed	Simultaneously switch the rotational speed of the low frequency rotor and high frequency rotor.	
	SLOW	Slows down the rotation to the Slow Rate.
	FAST	Speeds up the rotation to the Fast Rate.
Woofer Slow Speed	0.05-10.00 Hz	Slow speed (SLOW) of the low frequency rotor
Woofer Fast Speed	0.05-10.00 Hz	Fast speed (FAST) of the low frequency rotor
Woofer Acceleration	0-15	Adjusts the time it takes the low frequency rotor to reach the newly selected speed when switching from fast to slow (or slow to fast) speed. Lower values will require longer times.
Woofer Level	0-127	Volume of the low frequency rotor
Tweeter Slow Speed	0.05-10.00 Hz	Settings of the high frequency rotor The parameters are the same as for the low frequency rotor
Tweeter Fast Speed	0.05-10.00 Hz	
Tweeter Acceleration	0-15	
Tweeter Level	0-127	
Separation	0-127	Spatial dispersion of the sound
Level	0-127	Output Level

## 22: VK Rotary

This type provides modified response for the rotary speaker, with the low end boosted further.

This effect features the same specifications as the VK-7's built-in rotary speaker.

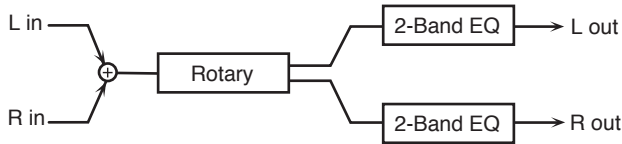

Parameter	Value	Explanation
Speed	Rotational speed of the rotating speaker	
	SLOW	Slow
	FAST	Fast
Brake	OFF, ON	Switches the rotation of the rotary speaker. When this is turned on, the rotation will gradually stop. When it is turned off, the rotation will gradually resume.
	0.05–10.00 Hz	Low-speed rotation speed of the woofer
Woofer Slow Speed	0.05–10.00 Hz	High-speed rotation speed of the woofer
Woofer Fast Speed	0–127	Adjusts the rate at which the woofer rotation speeds up when the rotation is switched from SLOW to FAST.
Woofer Trans Up	0–127	Adjusts the rate at which the woofer rotation speeds up when the rotation is switched from FAST to SLOW.
Woofer Trans Down	0–127	Volume of the woofer
Woofer Level	0–127	Settings of the tweeter
Tweeter Slow Speed	0.05–10.00 Hz	The parameters are the same as for the woofer.
Tweeter Fast Speed	0.05–10.00 Hz	
Tweeter Trans Up	0–127	
Tweeter Trans Down	0–127	
Tweeter Level	0–127	
Spread	0–10	Sets the rotary speaker stereo image. The higher the value set, the wider the sound is spread out.
Low Gain	-15–+15 dB	Gain of the low range
High Gain	-15–+15 dB	Gain of the high range
Level	0–127	Output Level

## 23: Chorus

This is a stereo chorus. A filter is provided so that you can adjust the timbre of the chorus sound.

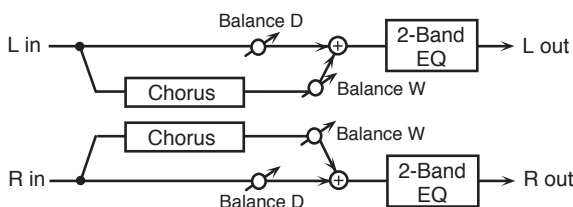

Parameter	Value	Explanation
Filter Type	Type of filter	
	OFF	No filter is used
	LPF	Cuts the frequency range above the Cutoff Freq
	HPF	Cuts the frequency range below the Cutoff Freq

Parameter	Value	Explanation
Cutoff Freq	200–8000 Hz	Center frequency when using the filter to cut a specific frequency range
Pre Delay	0.0–100 msec	Adjusts the delay time from the direct sound until the chorus sound is heard.
Rate	0.05–10.00 Hz, note	Frequency of modulation
Depth	0–127	Depth of modulation
Phase	0–180 deg	Spatial spread of the sound
Low Gain	-15–+15 dB	Gain of the low range
High Gain	-15–+15 dB	Gain of the high range
Balance	D100:0W–D0:100W	Volume balance between the direct sound (D) and the chorus sound (W)
Level	0–127	Output Level

## 24: Flanger

This is a stereo flanger (The LFO has the same phase for left and right). It produces a metallic resonance that rises and falls like a jet airplane taking off or landing. A filter is provided so that you can adjust the timbre of the flanged sound.

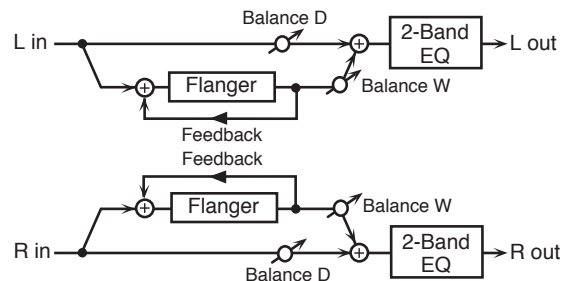

Parameter	Value	Explanation
Filter Type	Type of filter	
	OFF	No filter is used
	LPF	Cuts the frequency range above the Cutoff Freq
	HPF	Cuts the frequency range below the Cutoff Freq
Cutoff Freq	200–8000 Hz	Center frequency when using the filter to cut a specific frequency range
Pre Delay	0.0–100 msec	Adjusts the delay time from when the direct sound begins until the flanger sound is heard.
Rate	0.05–10.00 Hz, note	Frequency of modulation
Depth	0–127	Depth of modulation
Phase	0–180 deg	Spatial spread of the sound
Feedback	-98–+98 %	Adjusts the proportion of the flanger sound that is fed back into the effect. Negative (-) settings will invert the phase.
	-15–+15 dB	Gain of the low range
High Gain	-15–+15 dB	Gain of the high range
Balance	D100:0W–D0:100W	Volume balance between the direct sound (D) and the flanger sound (W)
Level	0–127	Output Level

## 25: Step Flanger

This is a flanger in which the flanger pitch changes in steps. The speed at which the pitch changes can also be specified in terms of a note-value of a specified tempo.

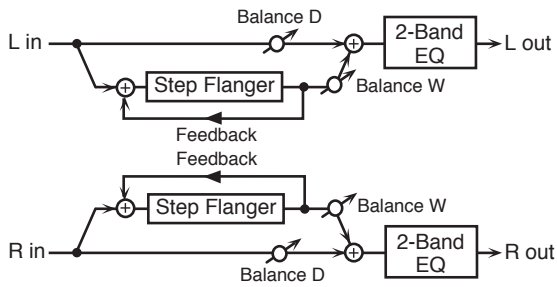

Parameter	Value	Explanation
Filter Type	Type of filter	
	OFF	No filter is used
	LPF	Cuts the frequency range above the Cutoff Freq
	HPF	Cuts the frequency range below the Cutoff Freq
Cutoff Freq	200–8000 Hz	Center frequency when using the filter to cut a specific frequency range
Pre Delay	0.0–100 msec	Adjusts the delay time from when the direct sound begins until the flanger sound is heard.
Rate	0.05–10.00 Hz, note	Frequency of modulation
Depth	0–127	Depth of modulation
Phase	0–180 deg	Spatial spread of the sound
Feedback	-98–+98 %	Adjusts the proportion of the flanger sound that is fed back into the effect. Negative (-) settings will invert the phase.
Step Rate	0.10–20.00 Hz, note	Rate (period) of pitch change
Low Gain	-15–+15 dB	Gain of the low range
High Gain	-15–+15 dB	Gain of the high range
Balance	D100:0W–D0:100W	Volume balance between the direct sound (D) and the flanger sound (W)
Level	0–127	Output Level

## 26: Hexa-Chorus

Uses a six-phase chorus (six layers of chorused sound) to give richness and spatial spread to the sound.

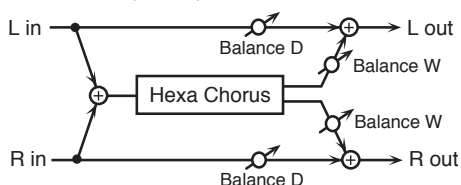

Parameter	Value	Explanation
Pre Delay	0.0–100 msec	Adjusts the delay time from the direct sound until the chorus sound is heard.
Rate	0.05–10.00 Hz, note	Frequency of modulation
Depth	0–127	Depth of modulation
Pre Delay Deviation	0–20	Adjusts the differences in Pre Delay between each chorus sound.
Depth Deviation	-20–+20	Adjusts the difference in modulation depth between each chorus sound.

Parameter	Value	Explanation
Pan Deviation	0–20	Adjusts the difference in stereo location between each chorus sound.
	0	All chorus sounds will be in the center.
	20	Each chorus sound will be spaced at 60 degree intervals relative to the center.
Balance	D100:0W–D0:100W	Volume balance between the direct sound (D) and the chorus sound (W)
Level	0–127	Output Level

## 27: Tremolo Chorus

This is a chorus effect with added Tremolo (cyclic modulation of volume).

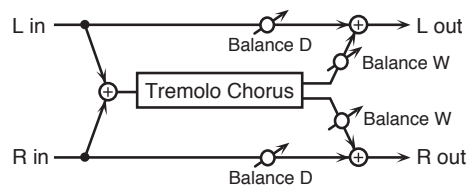

Parameter	Value	Explanation
Pre Delay	0.0–100 msec	Adjusts the delay time from the direct sound until the chorus sound is heard.
Chorus Rate	0.05–10.00 Hz, note	Modulation frequency of the chorus effect
Chorus Depth	0–127	Modulation depth of the chorus effect
Tremolo Rate	0.05–10.00 Hz, note	Modulation frequency of the tremolo effect
Tremolo Separation	0–127	Spread of the tremolo effect
Tremolo Phase	0–180 deg	Spread of the tremolo effect
Balance	D100:0W–D0:100W	Volume balance between the direct sound (D) and the tremolo chorus sound (W)
Level	0–127	Output Level

## 28: Space-D

This is a multiple chorus that applies two-phase modulation in stereo. It gives no impression of modulation, but produces a transparent chorus effect.

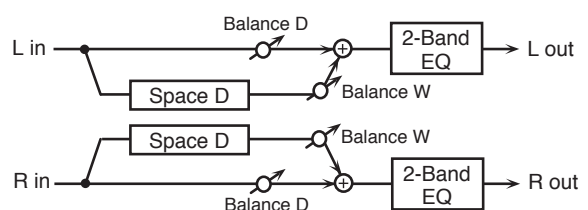

Parameter	Value	Explanation
Pre Delay	0.0–100 msec	Adjusts the delay time from the direct sound until the chorus sound is heard.
Rate	0.05–10.00 Hz, note	Frequency of modulation
Depth	0–127	Depth of modulation
Phase	0–180 deg	Spatial spread of the sound
Low Gain	-15–+15 dB	Gain of the low range
High Gain	-15–+15 dB	Gain of the high range
Balance	D100:0W–D0:100W	Volume balance between the direct sound (D) and the chorus sound (W)
Level	0–127	Output Level

## 29: 3D Chorus

This applies a 3D effect to the chorus sound. The chorus sound will be positioned 90 degrees left and 90 degrees right.

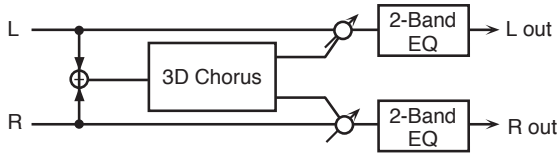

Parameter	Value	Explanation
Filter Type	Type of filter	
	OFF	No filter is used
	LPF	Cuts the frequency range above the Cutoff Freq
Cutoff Freq	HPF	Cuts the frequency range below the Cutoff Freq
	200–8000 Hz	Center frequency when using the filter to cut a specific frequency range
Pre Delay	0.0–100 msec	Adjusts the delay time from the direct sound until the chorus sound is heard.
Rate	0.05–10.00 Hz, note	Frequency of modulation
Depth	0–127	Modulation depth of the chorus effect
Phase	0–180 deg	Spatial spread of the sound
Output Mode	The optimal 3D effect will be achieved.	
	Speaker	When using speakers
	Phones	When using headphones
Low Gain	-15–+15 dB	Gain of the low range
High Gain	-15–+15 dB	Gain of the high range
Balance	D100:0W–D0:100W	Volume balance between the direct sound (D) and the chorus sound (W)
Level	0–127	Output Level

Parameter	Value	Explanation
Output Mode	The optimal 3D effect will be achieved.	
	Speaker	When using speakers
	Phones	When using headphones
Low Gain	-15–+15 dB	Gain of the low range
High Gain	-15–+15 dB	Gain of the high range
Balance	D100:0W–D0:100W	Volume balance between the direct sound (D) and the flanger sound (W)
Level	0–127	Output Level

## 31: 3D Step Flanger

This applies a 3D effect to the step flanger sound. The flanger sound will be positioned 90 degrees left and 90 degrees right.

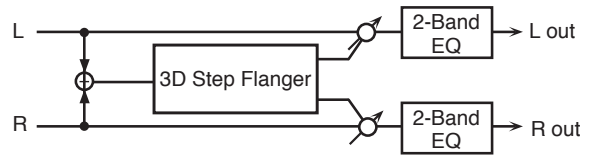

Parameter	Value	Explanation
Filter Type	Type of filter	
	OFF	No filter is used
	LPF	Cuts the frequency range above the Cutoff Freq
Cutoff Freq	HPF	Cuts the frequency range below the Cutoff Freq
	200–8000 Hz	Center frequency when using the filter to cut a specific frequency range
Pre Delay	0.0–100 msec	Adjusts the delay time from when the direct sound begins until the flanger sound is heard.
Rate	0.05–10.00 Hz, note	Frequency of modulation
Depth	0–127	Depth of modulation
Phase	0–180 deg	Spatial spread of the sound
Feedback	-98–+98 %	Adjusts the proportion of the flanger sound that is fed back into the effect. Negative (-) settings will invert the phase.
Step Rate	0.10–20.00 Hz, note	Rate (period) of pitch change
Output Mode	The optimal 3D effect will be achieved.	
	Speaker	When using speakers
	Phones	When using headphones
Low Gain	-15–+15 dB	Gain of the low range
High Gain	-15–+15 dB	Gain of the high range
Balance	D100:0W–D0:100W	Volume balance between the direct sound (D) and the flanger sound (W)
Level	0–127	Output Level

## 30: 3D Flanger

This applies a 3D effect to the flanger sound. The flanger sound will be positioned 90 degrees left and 90 degrees right.

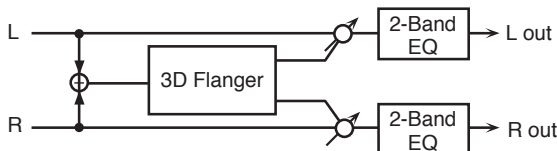

Parameter	Value	Explanation
Filter Type	Type of filter	
	OFF	No filter is used
	LPF	Cuts the frequency range above the Cutoff Freq
Cutoff Freq	HPF	Cuts the frequency range below the Cutoff Freq
	200–8000 Hz	Center frequency when using the filter to cut a specific frequency range
Pre Delay	0.0–100 msec	Adjusts the delay time from when the direct sound begins until the flanger sound is heard.
Rate	0.05–10.00 Hz, note	Frequency of modulation
Depth	0–127	Depth of modulation
Phase	0–180 deg	Spatial spread of the sound
Feedback	-98–+98 %	Adjusts the proportion of the flanger sound that is fed back into the effect. Negative (-) settings will invert the phase.

### 32: 2 Band Chorus

A chorus effect that lets you apply an effect independently to the low-frequency and high-frequency ranges.

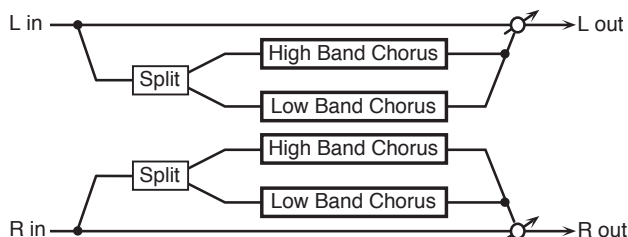

Parameter	Value	Explanation
Split Freq	200–8000 Hz	Frequency at which the low and high ranges will be divided
Low Pre Delay	0.0–100 msec	Delay time from when the original sound is heard to when the low-range chorus sound is heard
Low Rate	0.05–10.00 Hz, note	Rate at which the low-range chorus sound is modulated
Low Depth	0–127	Modulation depth for the low-range chorus sound
Low Phase	0–180 deg	Spaciousness of the low-range chorus sound
High Pre Delay	0.0–100 msec	Delay time from when the original sound is heard to when the high-range chorus sound is heard
High Rate	0.05–10.00 Hz, note	Rate at which the low-range chorus sound is modulated
High Depth	0–127	Modulation depth for the high-range chorus sound
High Phase	0–180 deg	Spaciousness of the high-range chorus sound
Balance	D100:0W–D0:100W	Volume balance of the original sound (D) and chorus sound (W)
Level	0–127	Output Level

### 33: 2 Band Flanger

A flanger that lets you apply an effect independently to the low-frequency and high-frequency ranges.

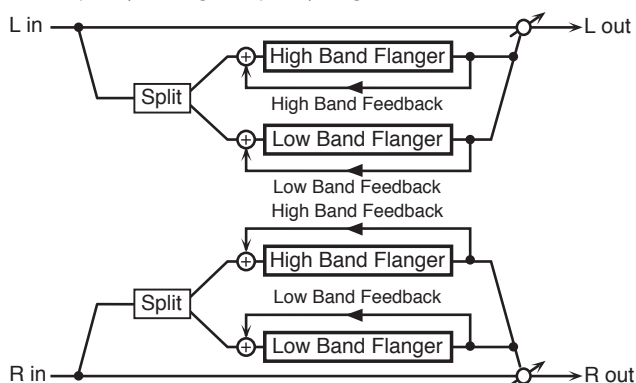

Parameter	Value	Explanation
Split Freq	200–8000 Hz	Frequency at which the low and high ranges will be divided
Low Pre Delay	0.0–100 msec	Delay time from when the original sound is heard to when the low-range flanger sound is heard
Low Rate	0.05–10.00 Hz, note	Rate at which the low-range flanger sound is modulated
Low Depth	0–127	Modulation depth for the low-range flanger sound
Low Phase	0–180 deg	Spaciousness of the low-range flanger sound

Parameter	Value	Explanation
Low Feedback	-98–+98 %	Proportion of the low-range flanger sound that is to be returned to the input (negative (-) values invert the phase)
High Pre Delay	0.0–100 msec	Delay time from when the original sound is heard to when the high-range flanger sound is heard
High Rate	0.05–10.00 Hz, note	Rate at which the high-range flanger sound is modulated
High Depth	0–127	Modulation depth for the high-range flanger sound
High Phase	0–180 deg	Spaciousness of the high-range flanger sound
High Feedback	-98–+98 %	Proportion of the high-range flanger sound that is to be returned to the input (negative (-) values invert the phase)
Balance	D100:0W–D0:100W	Volume balance of the original sound (D) and flanger sound (W)
Level	0–127	Output Level

### 34: 2 Band Step Flanger

A step flanger that lets you apply an effect independently to the low-frequency and high-frequency ranges.

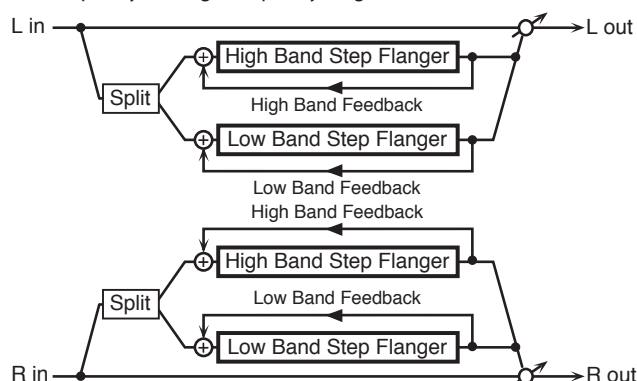

Parameter	Value	Explanation
Split Freq	200–8000 Hz	Frequency at which the low and high ranges will be divided
Low Pre Delay	0.0–100 msec	Delay time from when the original sound is heard to when the low-range flanger sound is heard
Low Rate	0.05–10.00 Hz, note	Rate at which the low-range flanger sound is modulated
Low Depth	0–127	Modulation depth for the low-range flanger sound
Low Phase	0–180 deg	Spaciousness of the low-range flanger sound
Low Feedback	-98–+98 %	Proportion of the low-range flanger sound that is to be returned to the input (negative (-) values invert the phase)
Low Step Rate	0.10–20.00 Hz, note	Rate at which the steps will cycle for the low-range flanger sound
High Pre Delay	0.0–100 msec	Delay time from when the original sound is heard to when the high-range flanger sound is heard
High Rate	0.05–10.00 Hz, note	Rate at which the high-range flanger sound is modulated
High Depth	0–127	Modulation depth for the high-range flanger sound
High Phase	0–180 deg	Spaciousness of the high-range flanger sound

## IFX Parameters

Parameter	Value	Explanation
High Feedback	-98→+98 %	Proportion of the high-range flanger sound that is to be returned to the input (negative (-) values invert the phase)
High Step Rate	0.10–20.00 Hz, note	Rate at which the steps will cycle for the high-range flanger sound
Balance	D100:0W–D0:100W	Volume balance of the original sound (D) and flanger sound (W)
Level	0–127	Output Level

### 35: Overdrive

Creates a soft distortion similar to that produced by vacuum tube amplifiers.

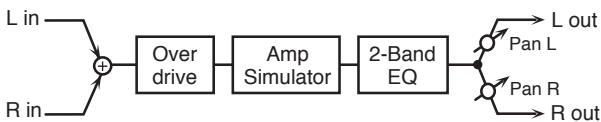

Parameter	Value	Explanation
Drive	0–127	Degree of distortion Also changes the volume.
Amp Type	Type of guitar amp	
	SMALL	Small amp
	BUILT-IN	Single-unit type amp
	2-STACK	Large double stack amp
	3-STACK	Large triple stack amp
Low Gain	-15→+15 dB	Gain of the low range
High Gain	-15→+15 dB	Gain of the high range
Pan	L64–63R	Stereo location of the output sound
Level	0–127	Output Level

### 36: Distortion

Produces a more intense distortion than Overdrive. The parameters are the same as for “35: Overdrive.”

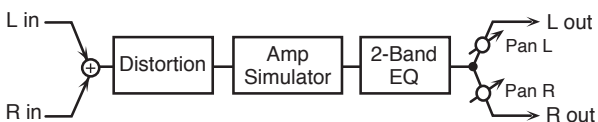

### 37: VS Overdrive

This is an overdrive that provides heavy distortion.

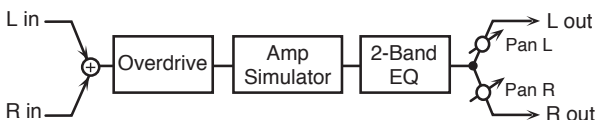

Parameter	Value	Explanation
Drive	0–127	Degree of distortion Also changes the volume.
Tone	0–127	Sound quality of the Overdrive effect
Amp Sw	OFF, ON	Turns the Amp Simulator on/off.
Amp Type	Type of guitar amp	
	SMALL	Small amp
	BUILT-IN	Single-unit type amp
	2-STACK	Large double stack amp
	3-STACK	Large triple stack amp
Low Gain	-15→+15 dB	Gain of the low range
High Gain	-15→+15 dB	Gain of the high range
Pan	L64–63R	Stereo location of the output sound
Level	0–127	Output Level

### 38: VS Distortion

This is a distortion effect that provides heavy distortion. The parameters are the same as for “37: VS Overdrive.”

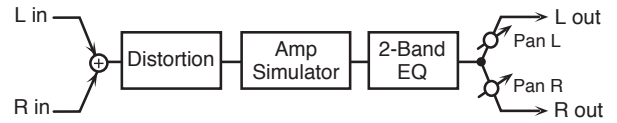

### 39: Guitar Amp Simulator

This is an effect that simulates the sound of a guitar amplifier.

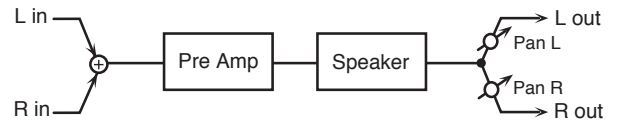

Parameter	Value	Explanation
Pre Amp Sw	OFF, ON	Turns the amp switch on/off.
Pre Amp Type	JC-120, CLEAN TWIN, MATCH DRIVE, BG LEAD, MS1959I, MS1959II, MS1959I+II, SLDN LEAD, METAL 5150, METAL LEAD, OD-1, OD-2 TURBO, DISTORTION, FUZZ	Type of guitar amp
Pre Amp Volume	0–127	Volume and amount of distortion of the amp
Pre Amp Master	0–127	Volume of the entire pre-amp
Pre Amp Gain	LOW, MIDDLE, HIGH	Amount of pre-amp distortion
Pre Amp Bass	0–127	Tone of the bass/mid/treble frequency range Middle cannot be set if “MATCH DRIVE” is selected as the Pre Amp Type.
Pre Amp Middle		
Pre Amp Treble		
Pre Amp Presence	0–127	Tone for the ultra-high frequency range
Pre Amp Bright	OFF, ON	Turning this “On” produces a sharper and brighter sound. This parameter applies to the “JC-120,” “CLEAN TWIN,” and “BG LEAD” Pre Amp Types.
Speaker Sw	OFF, ON	Determines whether the signal passes through the speaker (ON), or not (OFF).
Speaker Type	(See the following table)	Type of speaker
Mic Setting	1, 2, 3	Adjusts the location of the microphone that’s capturing the sound of the speaker. This can be adjusted in three steps, from 1 to 3, with the microphone becoming more distant as the value increases.
Mic Level	0–127	Volume of the microphone
Direct Level	0–127	Volume of the direct sound
Pan	L64–63R	Stereo location of the output sound
Level	0–127	Output Level



**Specifications for each Speaker Type**

The speaker column indicates the diameter of each speaker unit (in inches) and the number of units.

Type	Cabinet	Speaker	Microphone
SMALL 1	Small open-back enclosure	10	Dynamic
SMALL 2	Small open-back enclosure	10	Dynamic
MIDDLE	Open back enclosure	12 x 1	Dynamic
JC-120	Open back enclosure	12 x 2	Dynamic
BUILT-IN 1	Open back enclosure	12 x 2	Dynamic
BUILT-IN 2	Open back enclosure	12 x 2	Condenser
BUILT-IN 3	Open back enclosure	12 x 2	Condenser
BUILT-IN 4	Open back enclosure	12 x 2	Condenser
BUILT-IN 5	Open back enclosure	12 x 2	Condenser
BG STACK 1	Sealed enclosure	12 x 2	Condenser
BG STACK 2	Large sealed enclosure	12 x 2	Condenser
MS STACK 1	Large sealed enclosure	12 x 4	Condenser
MS STACK 2	Large sealed enclosure	12 x 4	Condenser
METAL STACK	Large double stack	12 x 4	Condenser
2-STACK	Large double stack	12 x 4	Condenser
3-STACK	Large triple stack	12 x 4	Condenser

**40: Compressor**

Flattens out high levels and boosts low levels, smoothing out fluctuations in volume.

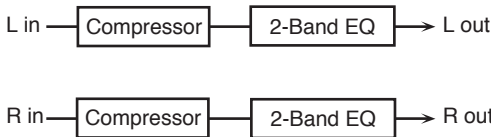

Parameter	Value	Explanation
Attack	0–127	Sets the time from when the input exceeds the Threshold until the volume starts being compressed
Threshold	0–127	Adjusts the volume at which compression begins
Post Gain	0–+18 dB	Adjusts the output gain.
Low Gain	-15–+15 dB	Gain of the low range
High Gain	-15–+15 dB	Gain of the high range
Level	0–127	Output Level

**41: Limiter**

Compresses signals that exceed a specified volume level, preventing distortion from occurring.

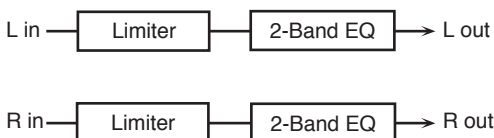

Parameter	Value	Explanation
Release	0–127	Adjusts the time after the signal volume falls below the Threshold Level until compression is no longer applied.
Threshold	0–127	Adjusts the volume at which compression begins
Ratio	1.5:1, 2:1, 4:1, 100:1	Compression ratio
Post Gain	0–+18 dB	Adjusts the output gain.
Low Gain	-15–+15 dB	Gain of the low range

Parameter	Value	Explanation
High Gain	-15–+15 dB	Gain of the high range
Level	0–127	Output Level

**42: Gate**

Cuts the reverb's delay according to the volume of the sound sent into the effect. Use this when you want to create an artificial-sounding decrease in the reverb's decay.

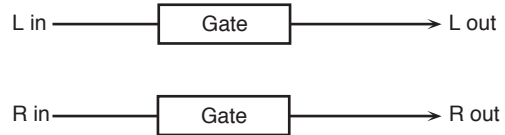

Parameter	Value	Explanation
Threshold	0–127	Volume level at which the gate begins to close
Mode	Type of gate	
	GATE	The gate will close when the volume of the original sound decreases, cutting the original sound.
	DUCK (Ducking)	The gate will close when the volume of the original sound increases, cutting the original sound.
Attack	0–127	Adjusts the time it takes for the gate to fully open after being triggered.
Hold	0–127	Adjusts the time it takes for the gate to start closing after the source sound falls beneath the Threshold.
Release	0–127	Adjusts the time it takes the gate to fully close after the hold time.
Balance	D100:0W–D0:100W	Volume balance between the direct sound (D) and the effect sound (W)
Level	0–127	Output Level

**43: Delay**

This is a stereo delay.

**When Feedback Mode is NORMAL:**

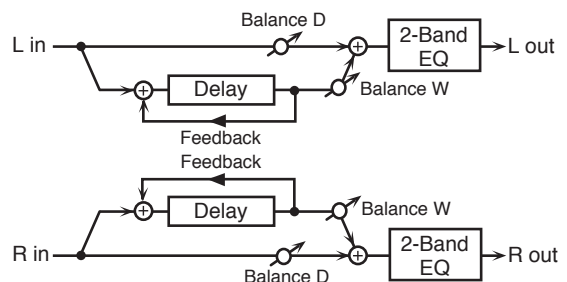

**When Feedback Mode is CROSS:**

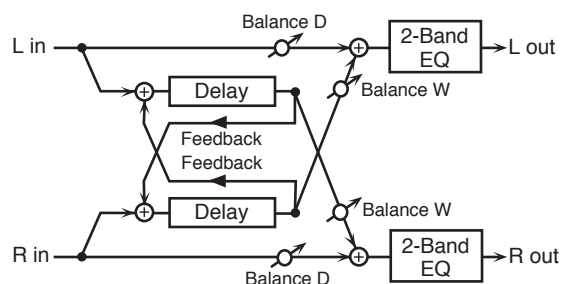

Parameter	Value	Explanation
Delay Left	0–1300 msec, note	Adjusts the time until the delay sound is heard.
Delay Right		
Phase Left	Phase of the left delay sound	
	NORMAL	Non-inverted
	INVERT	Inverted
Phase Right	Phase of the right delay sound	
	NORMAL	Non-inverted
	INVERT	Inverted
Feedback Mode	NORMAL, CROSS	Selects the way in which delay sound is fed back into the effect (See the figures.).
Feedback	-98–+98 %	Adjusts the amount of the delay sound that's fed back into the effect. Negative (-) settings invert the phase.
HF Damp	200–8000 Hz, BYPASS	Adjusts the frequency above which sound fed back to the effect is filtered out. If you don't want to filter out any high frequencies, set this parameter to BYPASS.
Low Gain	-15–+15 dB	Gain of the low range
High Gain	-15–+15 dB	Gain of the high range
Balance	D100:0W–D0:100W	Volume balance between the direct sound (D) and the delay sound (W)
Level	0–127	Output Level

## 44: Long Delay

A delay that provides a long delay time.

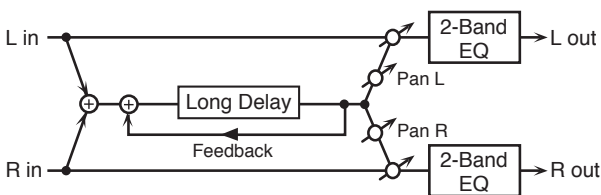

Parameter	Value	Explanation
Delay Time	0–2600 msec, note	Delay time from when the original sound is heard to when the delay sound is heard
Phase	NORMAL, INVERSE	Phase of the delay (NORMAL: non-inverted, INVERT: inverted)
Feedback	-98–+98 %	Proportion of the delay sound that is to be returned to the input (negative (-) values invert the phase)
HF Damp	200–8000 Hz, BYPASS	Frequency at which the high-frequency content of the delayed sound will be cut (BYPASS: no cut)
Pan	L64–63R	Panning of the delay sound
Low Gain	-15–+15 dB	Gain of the low range
High Gain	-15–+15 dB	Gain of the high range
Balance	D100:0W–D0:100W	Volume balance of the original sound (D) and delay sound (W)
Level	0–127	Output Level

## 45: Serial Delay

This delay connects two delay units in series. Feedback can be applied independently to each delay unit, allowing you to produce complex delay sounds.

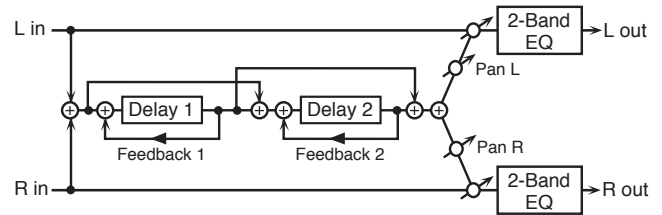

Parameter	Value	Explanation
Delay 1 Time	0–1300 msec, note	Delay time from when sound is input to delay 1 until the delay sound is heard
Delay 1 Feedback	-98–+98 %	Proportion of the delay sound that is to be returned to the input of delay 1 (negative (-) values invert the phase)
Delay 1 HF Damp	200–8000 Hz, BYPASS	Frequency at which the high-frequency content of the delayed sound of delay 1 will be cut (BYPASS: no cut)
Delay 2 Time	0–1300 msec, note	Proportion of the delay sound that is to be returned to the input of delay 2 (negative (-) values invert the phase)
Delay 2 Feedback	-98–+98 %	Proportion of the delay sound that is to be returned to the input of delay 2 (negative (-) values invert the phase)
Delay 2 HF Damp	200–8000 Hz, BYPASS	Frequency at which the high-frequency content of the delayed sound of delay 2 will be cut (BYPASS: no cut)
Pan	L64–63R	Panning of the delay sound
Low Gain	-15–+15 dB	Gain of the low range
High Gain	-15–+15 dB	Gain of the high range
Balance	D100:0W–D0:100W	Volume balance of the original sound (D) and delay sound (W)
Level	0–127	Output Level

## 46: Modulation Delay

Adds modulation to the delayed sound.

**When Feedback Mode is NORMAL:**

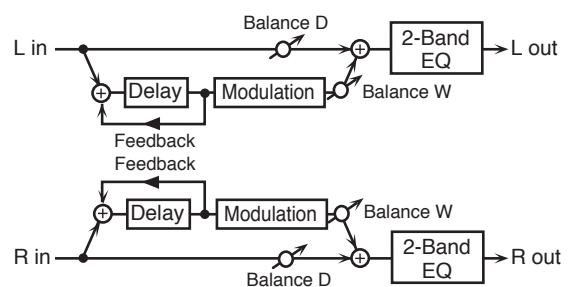

**When Feedback Mode is CROSS:**

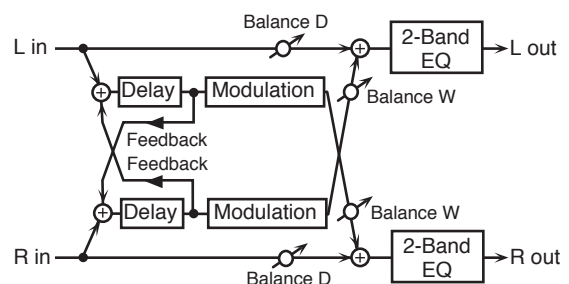

Parameter	Value	Explanation
Delay Left	0–1300 msec, note	Adjusts the time until the delay sound is heard.
Delay Right		
Feedback Mode	NORMAL, CROSS	Selects the way in which delay sound is fed back into the effect (See the figures.)
Feedback	-98–+98 %	Adjusts the amount of the delay sound that's fed back into the effect. Negative (-) settings invert the phase.
HF Damp	200–8000 Hz, BYPASS	Adjusts the frequency above which sound fed back to the effect is filtered out. If you don't want to filter out any high frequencies, set this parameter to BYPASS.
Rate	0.05–10.00 Hz, note	Frequency of modulation
Depth	0–127	Depth of modulation
Phase	0–180 deg	Spatial spread of the sound
Low Gain	-15–+15 dB	Gain of the low range
High Gain	-15–+15 dB	Gain of the high range
Balance	D100:0W–D0:100W	Volume balance between the direct sound (D) and the delay sound (W)
Level	0–127	Output Level

### 47: 3Tap Pan Delay

Produces three delay sounds; center, left and right.

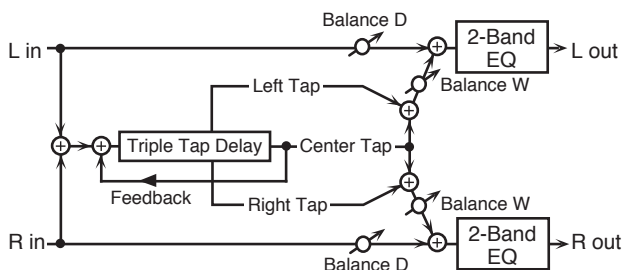

Parameter	Value	Explanation
Delay Left/Right/Center	0–2600 msec, note	Adjusts the time from the original sound until the left, right, and center delayed sounds are heard
Center Feedback	-98–+98 %	Adjusts the amount of the delay sound that's fed back into the effect. Negative (-) settings invert the phase.
HF Damp	200–8000 Hz, BYPASS	Adjusts the frequency above which sound fed back to the effect is filtered out. If you do not want to filter out any high frequencies, set this parameter to BYPASS.
Left/Right/Center Level	0–127	Volume of each delay
Low Gain	-15–+15 dB	Gain of the low range
High Gain	-15–+15 dB	Gain of the high range
Balance	D100:0W–D0:100W	Volume balance between the direct sound (D) and the delay sound (W)
Level	0–127	Output Level

### 48: 4Tap Pan Delay

This effect has four delays.

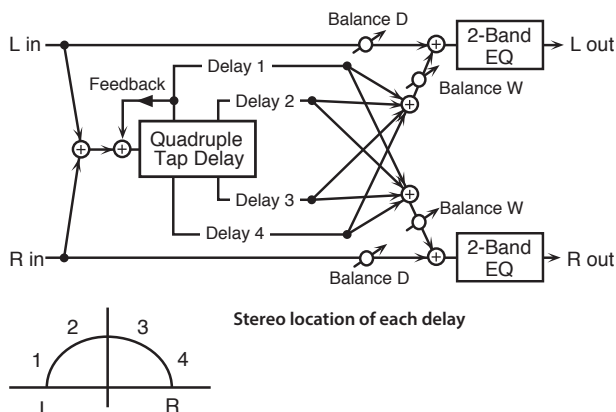

Parameter	Value	Explanation
Delay 1-4 Time	0–2600 msec, note	Adjusts the time from the original sound until delay sounds 1–4 are heard
Delay 1 Feedback	-98–+98 %	Adjusts the amount of the delay sound that's fed back into the effect. Negative (-) settings invert the phase.
HF Damp	200–8000 Hz, BYPASS	Adjusts the frequency above which sound fed back to the effect is filtered out. If you do not want to filter out any high frequencies, set this parameter to BYPASS.
Delay 1-4 Level	0–127	Volume of each delay
Low Gain	-15–+15 dB	Gain of the low range
High Gain	-15–+15 dB	Gain of the high range
Balance	D100:0W–D0:100W	Volume balance between the direct sound (D) and the delay sound (W)
Level	0–127	Output Level

### 49: Multi Tap Delay

This effect provides four delays. Each of the Delay Time parameters can be set to a note length based on the selected tempo. You can also set the panning and level of each delay sound.

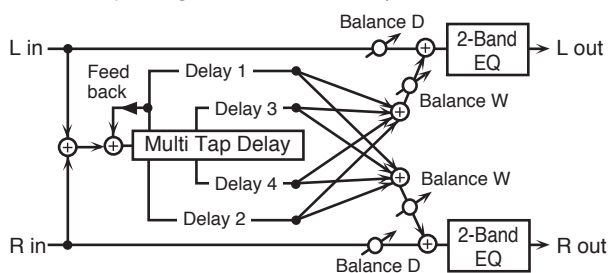

Parameter	Value	Explanation
Delay 1-4 Time	0–2600 msec, note	Adjusts the time until Delays 1–4 are heard.
Delay 1 Feedback	-98–+98 %	Adjusts the amount of the delay sound that's fed back into the effect. Negative (-) settings invert the phase.
HF Damp	200–8000 Hz, BYPASS	Adjusts the frequency above which sound fed back to the effect is filtered out. If you do not want to filter out any the high frequencies, set this parameter to BYPASS.
Delay 1-4 Pan	L64–63R	Stereo location of Delays 1–4
Delay 1-4 Level	0–127	Output level of Delays 1–4
Low Gain	-15–+15 dB	Gain of the low range
High Gain	-15–+15 dB	Gain of the high range

Parameter	Value	Explanation
Balance	D100:0W–D0:100W	Volume balance between the direct sound (D) and the effect sound (W)
Level	0–127	Output Level

## 50: Reverse Delay

This is a reverse delay that adds a reversed and delayed sound to the input sound. A tap delay is connected immediately after the reverse delay.

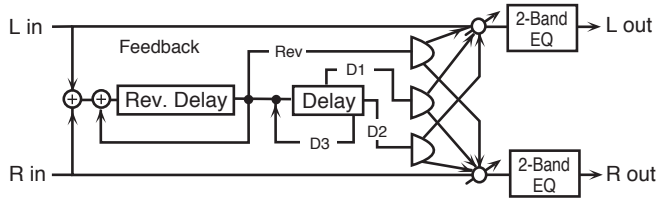

Parameter	Value	Explanation
Threshold	0–127	Volume at which the reverse delay will begin to be applied
Rev Delay Time	0–1300 msec, note	Delay time from when sound is input into the reverse delay until the delay sound is heard
Rev Delay Feedback	-98–+98 %	Proportion of the delay sound that is to be returned to the input of the reverse delay (negative (-) values invert the phase)
Rev Delay HF Damp	200–8000 Hz, BYPASS	Frequency at which the high-frequency content of the reverse-delayed sound will be cut (BYPASS: no cut)
Rev Delay Pan	L64–63R	Panning of the reverse delay sound
Rev Delay Level	0–127	Volume of the reverse delay sound
Delay 1 - 3 Time	0–1300 msec, note	Delay time from when sound is input into the tap delay until the delay sound is heard
Delay 3 Feedback	-98–+98 %	Proportion of the delay sound that is to be returned to the input of the tap delay (negative (-) values invert the phase)
Delay HF Damp	200–8000 Hz, BYPASS	Frequency at which the hi-frequency content of the tap delay sound will be cut (BYPASS: no cut)
Delay 1 Pan, Delay 2 Pan	L64–63R	Panning of the tap delay sounds
Delay 1 Level, Delay 2 Level	0–127	Volume of the tap delay sounds
Low Gain	-15–+15 dB	Gain of the low range
High Gain	-15–+15 dB	Gain of the high range
Balance	D100:0W–D0:100W	Volume balance of the original sound (D) and delay sound (W)
Level	0–127	Output Level

## 51: Shuffle Delay

Adds a shuffle to the delay sound, giving the sound a bouncy delay effect with a swing feel.

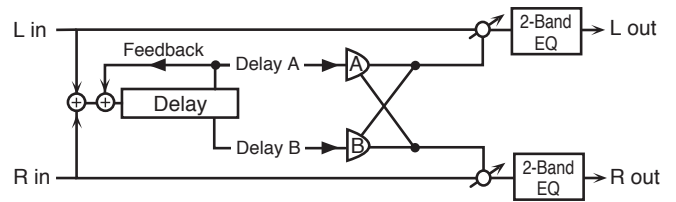

Parameter	Value	Explanation
Delay Time	0–2600 msec, note	Adjusts the time until the delay sound is heard.
Shuffle Rate	0–100	Adjusts the ratio (as a percentage) of the time that elapses before Delay B sounds relative to the time that elapses before the Delay A sounds. When set to 100, the delay times are the same.
Acceleration	0–15	Adjusts the speed which the Delay Time changes from the current setting to its specified new setting.
Feedback	-98–+98 %	Adjusts the amount of the delay that's feedback into the effect. Negative (-) settings invert the phase.
HF Damp	200–8000 Hz, BYPASS	Adjusts the frequency above which sound fed back to the effect is filtered out. If you don't want to filter out any high frequencies, set this parameter to BYPASS.
Pan A/B	L64–63R	Stereo location of Delay A/B
Level A/B	0–127	Volume of delay A/B
Low Gain	-15–+15 dB	Gain of the low range
High Gain	-15–+15 dB	Gain of the high range
Balance	D100:0W–D0:100W	Volume balance between the direct sound (D) and the effect sound (W)
Level	0–127	Output Level

## 52: 3D Delay

This applies a 3D effect to the delay sound. The delay sound will be positioned 90 degrees left and 90 degrees right.

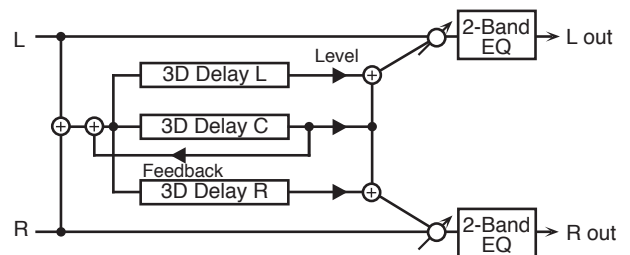

Parameter	Value	Explanation
Delay Left	0–2600 msec, note	Adjusts the delay time from the direct sound until the delay sound is heard.
Delay Right		
Delay Center		
Center Feedback	-98–+98 %	Adjusts the proportion of the delay sound that is fed back into the effect. Negative (-) settings will invert the phase.
HF Damp	200–8000 Hz, BYPASS	Adjusts the frequency above which sound fed back to the effect will be cut. If you do not want to cut the high frequencies, set this parameter to BYPASS.

Parameter	Value	Explanation
Left Level	0-127	Output level of the delay sound
Right Level		
Center Level		
Output Mode	The optimal 3D effect will be achieved.	
	Speaker	When using speakers
	Phones	When using headphones
Low Gain	-15-+15 dB	Gain of the low range
High Gain	-15-+15 dB	Gain of the high range
Balance	D100:0W- D0:100W	Volume balance between the direct sound (D) and the effect sound (W)
Level	0-127	Output Level

### 53: Time Ctrl Delay

A stereo delay in which the delay time can be varied smoothly.

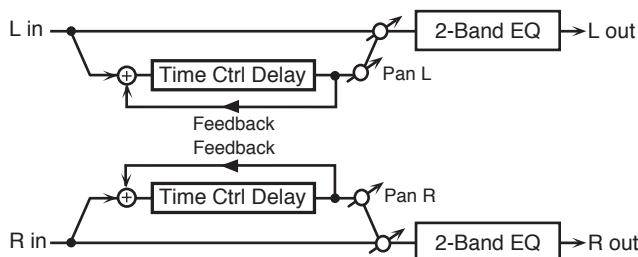

Parameter	Value	Explanation
Delay Time	0-1300 msec, note	Adjusts the time until the delay is heard.
Acceleration	0-15	Adjusts the speed which the Delay Time changes from the current setting to a specified new setting. The rate of change for the Delay Time directly affects the rate of pitch change.
Feedback	-98-+98 %	Adjusts the amount of the delay that's fed back into the effect. Negative (-) settings invert the phase.
HF Damp	200-8000 Hz, BYPASS	Adjusts the frequency above which sound fed back to the effect is filtered out. If you do not want to filter out any high frequencies, set this parameter to BYPASS.
Low Gain	-15-+15 dB	Gain of the low range
High Gain	-15-+15 dB	Gain of the high range
Balance	D100:0W- D0:100W	Volume balance between the direct sound (D) and the delay sound (W)
Level	0-127	Output Level

### 54: Long Time Ctrl Delay

A delay in which the delay time can be varied smoothly, and allowing an extended delay to be produced.

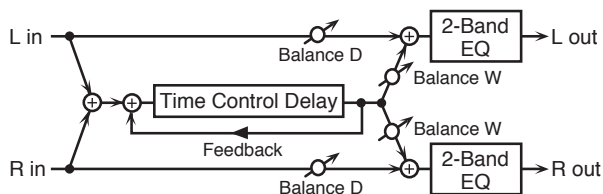

Parameter	Value	Explanation
Delay Time	0-2600 msec, note	Adjusts the time until the delay is heard.

Parameter	Value	Explanation
Acceleration	0-15	Adjusts the speed which the Delay Time changes from the current setting to a specified new setting. The rate of change for the Delay Time directly affects the rate of pitch change.
Feedback	-98-+98 %	Adjusts the amount of the delay that's fed back into the effect. Negative (-) settings invert the phase.
HF Damp	200-8000 Hz, BYPASS	Adjusts the frequency above which sound fed back to the effect is filtered out. If you do not want to filter out any high frequencies, set this parameter to BYPASS.
Pan	L64-63R	Stereo location of the delay
Low Gain	-15-+15 dB	Gain of the low range
High Gain	-15-+15 dB	Gain of the high range
Balance	D100:0W- D0:100W	Volume balance between the direct sound (D) and the delay sound (W)
Level	0-127	Output Level

### 55: Tape Echo

A virtual tape echo that produces a realistic tape delay sound. This simulates the tape echo section of a Roland RE-201 Space Echo.

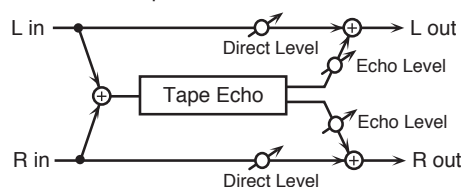

Parameter	Value	Explanation
Mode	S, M, L, S+M, S+L, M+L, S+M+L	Combination of playback heads to use. Select from three different heads with different delay times. S: short M: middle L: long
Repeat Rate	0-127	Tape speed. Increasing this value will shorten the spacing of the delayed sounds.
Intensity	0-127	Amount of delay repeats
Bass	-15-+15 dB	Boost/cut for the lower range of the echo sound
Treble	-15-+15 dB	Boost/cut for the upper range of the echo sound
Head S Pan	L64-63R	Independent panning for the short, middle, and long playback heads
Head M Pan		
Head L Pan		
Tape Distortion	0-5	Amount of tape-dependent distortion to be added. This simulates the slight tonal changes that can be detected by signal-analysis equipment. Increasing this value will increase the distortion.
Wow/Flutter Rate	0-127	Speed of wow/flutter (complex variation in pitch caused by tape wear and rotational irregularity)
Wow/Flutter Depth	0-127	Depth of wow/flutter
Echo Level	0-127	Volume of the echo sound
Direct Level	0-127	Volume of the original sound
Level	0-127	Output Level

## 56: Lofi Noise

In addition to a lo-fi effect, this adds various types of noise such as white noise and disc noise.

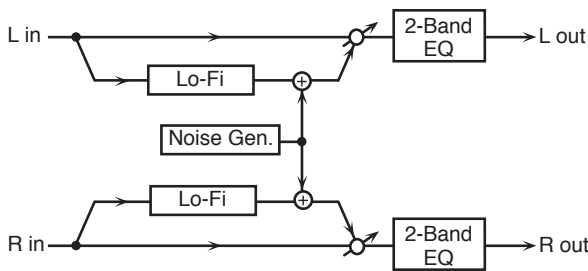

Parameter	Value	Explanation
<b>LoFi Type</b>	1-9	Degrades the sound quality. The sound quality grows poorer as this value is increased.
<b>Post Filter Type</b>	Type of filter that follows the LoFi effect	
	OFF	No filter is used
	LPF	Cuts the frequency range above the Cutoff.
	HPF	Cuts the frequency range below the Cutoff.
<b>Post Filter Cutoff</b>	200-8000 Hz	Center frequency of the filter
<b>W/P Noise Type</b>	WHITE, PINK	Switch between white noise and pink noise.
<b>W/P Noise LPF</b>	200-8000 Hz, BYPASS	Center frequency of the low pass filter applied to the white/pink noise (BYPASS: no cut)
<b>W/P Noise Level</b>	0-127	Volume of the white/pink noise
<b>Disc Noise Type</b>	LP, EP, SP, RND	Type of record noise The frequency at which the noise is heard depends on the selected type.
<b>Disc Noise LPF</b>	200-8000 Hz, BYPASS	Adjusts the cutoff frequency of the low pass filter applied to the record noise. If you don't want to filter out any high frequencies, set this parameter to BYPASS.
<b>Disc Noise Level</b>	0-127	Volume of the record noise
<b>Hum Noise Type</b>	50 Hz, 60 Hz	Frequency of the hum noise
<b>Hum Noise LPF</b>	200-8000 Hz, BYPASS	Center frequency of the low pass filter applied to the hum noise (BYPASS: no cut)
<b>Hum Noise Level</b>	0-127	Volume of the hum noise
<b>Low Gain</b>	-15-+15 dB	Gain of the low range
<b>High Gain</b>	-15-+15 dB	Gain of the high range
<b>Balance</b>	D100:0W- D0:100W	Volume balance between the direct sound (D) and the effect sound (W)
<b>Level</b>	0-127	Output Level

## 57: Lofi Compress

This is an effect that intentionally degrades the sound quality for creative purposes.

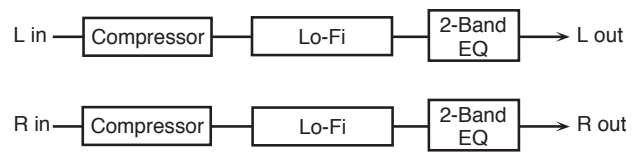

Parameter	Value	Explanation
<b>Pre Filter Type</b>	Selects the type of filter applied to the sound before it passes through the Lo-Fi effect.	
	1	Compressor off
	2-6	Compressor on
<b>LoFi Type</b>	1-9	Degrades the sound quality. The sound quality grows poorer as this value is increased.
<b>Post Filter Type</b>	Type of filter	
	OFF	No filter is used
	LPF	Cuts the frequency range above the Cutoff
	HPF	Cuts the frequency range below the Cutoff
<b>Post Filter Cutoff</b>	200-8000 Hz	Basic frequency of the Post Filter
<b>Low Gain</b>	-15-+15 dB	Gain of the low range
<b>High Gain</b>	-15-+15 dB	Gain of the high range
<b>Balance</b>	D100:0W- D0:100W	Volume balance between the direct sound (D) and the effect sound (W)
<b>Level</b>	0-127	Output Level

## 58: Lofi Radio

In addition to a Lo-Fi effect, this effect also generates radio noise.

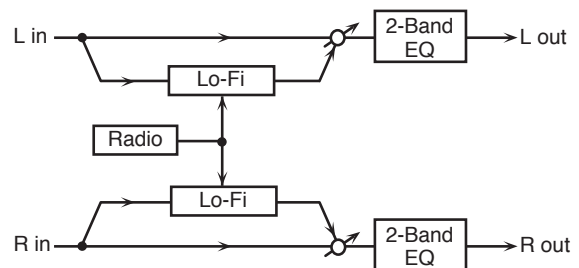

Parameter	Value	Explanation
<b>LoFi Type</b>	1-9	Degrades the sound quality. The sound quality grows poorer as this value is increased.
<b>Post Filter Type</b>	Type of filter	
	OFF	No filter is used
	LPF	Cuts the frequency range above the Cutoff.
	HPF	Cuts the frequency range below the Cutoff.
<b>Post Filter Cutoff</b>	200-8000 Hz	Basic frequency of the Post Filter
<b>Radio Detune</b>	0-127	Simulates the tuning noise of a radio. As this value is raised, the tuning drifts further.
<b>Radio Noise Level</b>	0-127	Volume of the radio noise
<b>Low Gain</b>	-15-+15 dB	Gain of the low range
<b>High Gain</b>	-15-+15 dB	Gain of the high range
<b>Balance</b>	D100:0W- D0:100W	Volume balance between the direct sound (D) and the effect sound (W)
<b>Level</b>	0-127	Output Level

### 59: Telephone

This effect produces a muffled sound, like that heard through a telephone.

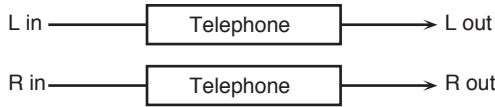

Parameter	Value	Explanation
Voice Quality	0–15	Audio quality of the telephone voice
Treble	-15–+15 dB	Bandwidth of the telephone voice
Balance	D100:0W–D0:100W	Volume balance between the direct sound (D) and the effect sound (W)
Level	0–127	Output Level

### 60: Phonograph

Simulates a sound recorded on an analog record and played back on a record player. This effect also simulates the various types of noise that are typical of a record, and even the rotational irregularities of an old turntable.

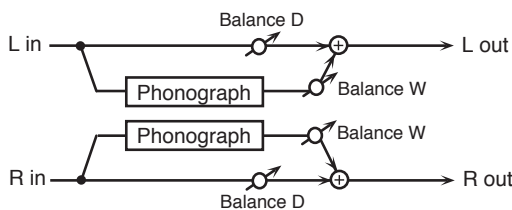

Parameter	Value	Explanation
Signal Distortion	0–127	Depth of distortion
Frequency Range	0–127	Frequency response of the playback system. Decreasing this value will produce the impression of an old system with a poor frequency response.
Disc Type	LP, EP, SP	Rotational speed of the turntable. This will affect the frequency of the scratch noise.
Scratch Noise Level	0–127	Amount of noise due to scratches on the record
Dust Noise Level	0–127	Volume of noise due to dust on the record
Hiss Noise Level	0–127	Volume of continuous "hiss"
Total Noise Level	0–127	Volume of overall noise
Wow	0–127	Depth of long-cycle rotational irregularity
Flutter	0–127	Depth of short-cycle rotational irregularity
Random	0–127	Depth of indefinite-cycle rotational irregularity
Total Wow/Flutter	0–127	Depth of overall rotational irregularity
Balance	D100:0W–D0:100W	Volume balance between the direct sound (D) and the effect sound (W)
Level	0–127	Output Level

### 61: Pitch Shifter

A stereo pitch shifter.

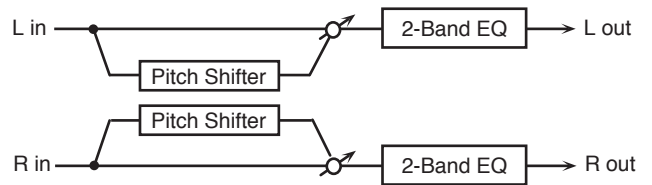

Parameter	Value	Explanation
Coarse	-24–+12 semi	Adjusts the pitch of the pitch shifted sound in semitone steps.
Fine	-100–+100 cent	Adjusts the pitch of the pitch shifted sound in 2-cent steps.
Delay Time	0–1300 msec, note	Adjusts the delay time from the direct sound until the pitch shifted sound is heard.
Feedback	-98–+98 %	Adjusts the proportion of the pitch shifted sound that is fed back into the effect. Negative (-) settings will invert the phase.
Low Gain	-15–+15 dB	Gain of the low range
High Gain	-15–+15 dB	Gain of the high range
Balance	D100:0W–D0:100W	Volume balance between the direct sound (D) and the pitch shifted sound (W)
Level	0–127	Output Level

### 62: 2Voice Pitch Shifter

Shifts the pitch of the original sound. This 2-voice pitch shifter has two pitch shifters, and can add two pitch shifted sounds to the original sound.

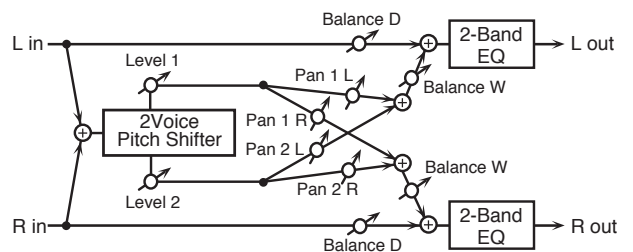

Parameter	Value	Explanation
Pitch1 Coarse	-24–+12 semi	Adjusts the pitch of Pitch Shift 1 in semitone steps.
Pitch1 Fine	-100–+100 cent	Adjusts the pitch of Pitch Shift 1 in 2-cent steps.
Pitch1 Delay	0–1300 msec, note	Adjusts the delay time from the direct sound until the Pitch Shift 1 sound is heard.
Pitch1 Feedback	-98–+98 %	Adjusts the proportion of the pitch shifted sound that is fed back into the effect. Negative (-) settings will invert the phase.
Pitch1 Pan	L64–63R	Stereo location of the Pitch Shift 1 sound
Pitch1 Level	0–127	Volume of the Pitch Shift1 sound
Pitch2 Coarse	-24–+12 semi	Settings of the Pitch Shift 2 sound. The parameters are the same as for the Pitch Shift 1 sound.
Pitch2 Fine	-100–+100 cent	
Pitch2 Delay	0–1300 msec, note	
Pitch2 Feedback	-98–+98 %	
Pitch2 Pan	L64–63R	
Pitch2 Level	0–127	
Low Gain	-15–+15 dB	Gain of the low range

## IFX Parameters

Parameter	Value	Explanation
High Gain	-15+15 dB	Gain of the high range
Balance	D100:0W- D0:100W	Volume balance between the direct sound (D) and the pitch shifted sound (W)
Level	0-127	Output Level

### 63: Step Pitch Shifter

A pitch shifter in which the amount of pitch shift is varied by a 16-step sequence.

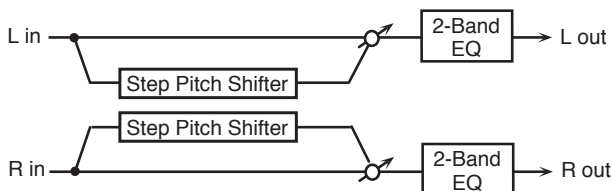

Parameter	Value	Explanation
Step 01-16	-24+12 semi	Amount of pitch shift at each step (semitone units)
Rate	0.05-10.0 Hz, note	Rate at which the 16-step sequence will cycle
Attack	0-127	Speed at which the amount of pitch shift changes between steps
Gate Time	0-127	Duration of the pitch shifted sound at each step
Fine	-100+100 cent	Pitch shift adjustment for all steps (2-cent units)
Delay Time	0-1300 msec, note	Delay time from the original sound until the pitch-shifted sound is heard
Feedback	-98+98 %	Proportion of the pitch-shifted sound that is to be returned to the input (negative (-) values invert the phase)
Low Gain	-15+15 dB	Gain of the low range
High Gain	-15+15 dB	Gain of the high range
Balance	D100:0W- D0:100W	Volume balance of the original sound (D) and pitch-shifted sound (W)
Level	0-127	Output Level

### 64: Reverb

Adds reverberation to the sound, simulating an acoustic space.

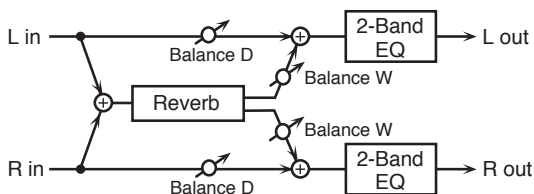

Parameter	Value	Explanation
Type	Type of reverb	
	ROOM1	Dense reverb with short decay
	ROOM2	Sparse reverb with short decay
	STAGE1	Reverb with greater late reverberation
	STAGE2	Reverb with strong early reflections
	HALL1	Reverb with clear reverberance
HALL2	Reverb with rich reverberance	
Pre Delay	0.0-100 msec	Adjusts the delay time from the direct sound until the reverb sound is heard.
Time	0-127	Time length of reverberation

Parameter	Value	Explanation
HF Damp	200-8000 Hz, BYPASS	Adjusts the frequency above which the reverberant sound will be cut. As the frequency is set lower, more of the high frequencies will be cut, resulting in a softer and more muted reverberance. If you do not want to cut the high frequencies, set this parameter to BYPASS.
Low Gain	-15+15 dB	Gain of the low range
High Gain	-15+15 dB	Gain of the high range
Balance	D100:0W- D0:100W	Volume balance between the direct sound (D) and the reverb sound (W)
Level	0-127	Output Level

### 65: Gated Reverb

This is a special type of reverb in which the reverberant sound is cut off before its natural length.

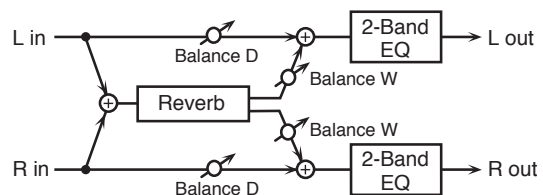

Parameter	Value	Explanation
Type	Type of reverb	
	NORMAL	Conventional gated reverb
	REVERSE	Backwards reverb
	SWEEP1	The reverberant sound moves from right to left
SWEEP2	The reverberant sound moves from left to right	
Pre Delay	0.0-100 msec	Adjusts the delay time from the direct sound until the reverb sound is heard.
Gate Time	5-500 msec	Adjusts the time from when the reverb is heard until it disappears.
Low Gain	-15+15 dB	Gain of the low range
High Gain	-15+15 dB	Gain of the high range
Balance	D100:0W- D0:100W	Volume balance between the direct sound (D) and the reverb sound (W)
Level	0-127	Output Level



### 66: Overdrive → Chorus

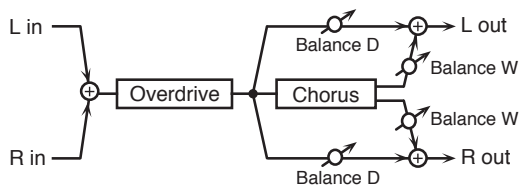

Parameter	Value	Explanation
Overdrive Drive	0–127	Degree of distortion Also changes the volume.
Overdrive Pan	L64–63R	Stereo location of the overdrive sound
Chorus Pre Delay	0.0–100 msec	Adjusts the delay time from the direct sound until the chorus sound is heard.
Chorus Rate	0.05–10.00 Hz, note	Frequency of modulation
Chorus Depth	0–127	Depth of modulation
Chorus Balance	D100:0W–D0:100W	Adjusts the volume balance between the sound that is sent through the chorus (W) and the sound that is not sent through the chorus (D).
Level	0–127	Output Level

### 67: Overdrive → Flanger

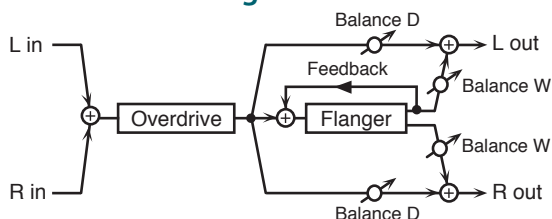

Parameter	Value	Explanation
Overdrive Drive	0–127	Degree of distortion Also changes the volume.
Overdrive Pan	L64–63R	Stereo location of the overdrive sound
Flanger Pre Delay	0.0–100 msec	Adjusts the delay time from when the direct sound begins until the flanger sound is heard.
Flanger Rate	0.05–10.00 Hz, note	Frequency of modulation
Flanger Depth	0–127	Depth of modulation
Flanger Feedback	-98–+98 %	Adjusts the proportion of the flanger sound that is fed back into the effect. Negative (-) settings will invert the phase.
Flanger Balance	D100:0W–D0:100W	Adjusts the volume balance between the sound that is sent through the flanger (W) and the sound that is not sent through the flanger (D).
Level	0–127	Output Level

### 68: Overdrive → Delay

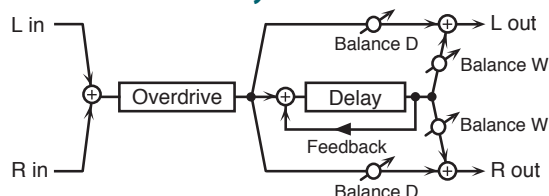

Parameter	Value	Explanation
Overdrive Drive	0–127	Degree of distortion Also changes the volume.
Overdrive Pan	L64–63R	Stereo location of the overdrive sound
Delay Time	0–2600 msec, note	Adjusts the delay time from the direct sound until the delay sound is heard.
Delay Feedback	-98–+98 %	Adjusts the proportion of the delay sound that is fed back into the effect. Negative (-) settings will invert the phase.
Delay HF Damp	200–8000 Hz, BYPASS	Adjusts the frequency above which sound fed back to the effect will be cut. If you do not want to cut the high frequencies, set this parameter to BYPASS.
Delay Balance	D100:0W–D0:100W	Adjusts the volume balance between the sound that is sent through the delay (W) and the sound that is not sent through the delay (D).
Level	0–127	Output Level

### 69: Distortion → Chorus

The parameters are essentially the same as in “66: Overdrive → Chorus,” with the exception of the following two.

Overdrive Drive → Distortion Drive,  
Overdrive Pan → Distortion Pan

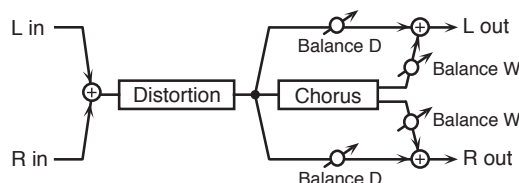

### 70: Distortion → Flanger

The parameters are essentially the same as in “67: Overdrive → Flanger,” with the exception of the following two.

Overdrive Drive → Distortion Drive,  
Overdrive Pan → Distortion Pan

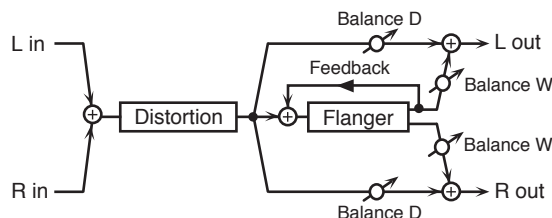

## 71: Distortion → Delay

The parameters are essentially the same as in “68: Overdrive → Delay,” with the exception of the following two.

Overdrive Drive → Distortion Drive,  
Overdrive Pan → Distortion Pan

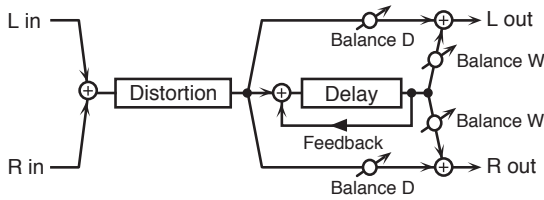

## 72: Enhancer → Chorus

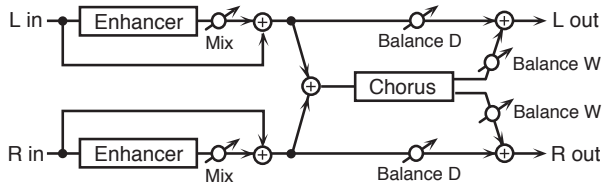

Parameter	Value	Explanation
Enhancer Sens	0–127	Sensitivity of the enhancer
Enhancer Mix	0–127	Level of the overtones generated by the enhancer
Chorus Pre Delay	0.0–100 msec	Adjusts the delay time from the direct sound until the chorus sound is heard.
Chorus Rate	0.05–10.00 Hz, note	Frequency of modulation
Chorus Depth	0–127	Depth of modulation
Chorus Balance	D100:0W–D0:100W	Adjusts the volume balance between the sound that is sent through the chorus (W) and the sound that is not sent through the chorus (D).
Level	0–127	Output Level

## 73: Enhancer → Flanger

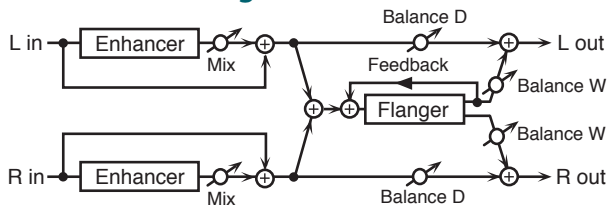

Parameter	Value	Explanation
Enhancer Sens	0–127	Sensitivity of the enhancer
Enhancer Mix	0–127	Level of the overtones generated by the enhancer
Flanger Pre Delay	0.0–100 msec	Adjusts the delay time from when the direct sound begins until the flanger sound is heard.
Flanger Rate	0.05–10.00 Hz, note	Frequency of modulation
Flanger Depth	0–127	Depth of modulation
Flanger Feedback	–98–+98 %	Adjusts the proportion of the flanger sound that is fed back into the effect. Negative (-) settings will invert the phase.
Flanger Balance	D100:0W–D0:100W	Adjusts the volume balance between the sound that is sent through the flanger (W) and the sound that is not sent through the flanger (D).
Level	0–127	Output Level

## 74: Enhancer → Delay

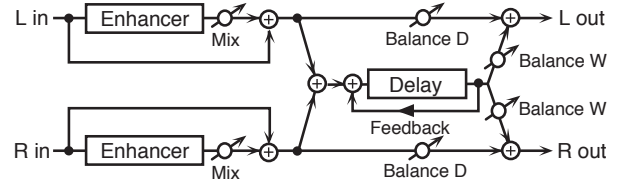

Parameter	Value	Explanation
Enhancer Sens	0–127	Sensitivity of the enhancer
Enhancer Mix	0–127	Level of the overtones generated by the enhancer
Delay Time	0–2600 msec, note	Adjusts the delay time from the direct sound until the delay sound is heard.
Delay Feedback	–98–+98 %	Adjusts the proportion of the delay sound that is fed back into the effect. Negative (-) settings will invert the phase.
Delay HF Damp	200–8000 Hz, BYPASS	Adjusts the frequency above which sound fed back to the effect will be cut. If you do not want to cut the high frequencies, set this parameter to BYPASS.
Delay Balance	D100:0W–D0:100W	Adjusts the volume balance between the sound that is sent through the delay (W) and the sound that is not sent through the delay (D).
Level	0–127	Output Level

## 75: Chorus → Delay

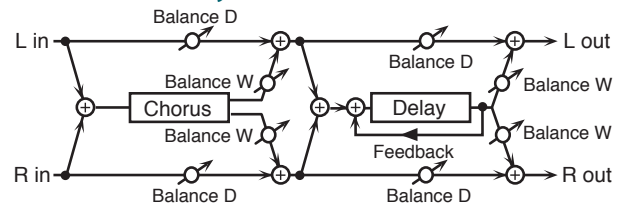

Parameter	Value	Explanation
Chorus Pre Delay	0.0–100 msec	Adjusts the delay time from the direct sound until the chorus sound is heard.
Chorus Rate	0.05–10.00 Hz, note	Frequency of modulation
Chorus Depth	0–127	Depth of modulation
Chorus Balance	D100:0W–D0:100W	Volume balance between the direct sound (D) and the chorus sound (W)
Delay Time	0–2600 msec, note	Adjusts the delay time from the direct sound until the delay sound is heard.
Delay Feedback	–98–+98 %	Adjusts the proportion of the delay sound that is fed back into the effect. Negative (-) settings will invert the phase.
Delay HF Damp	200–8000 Hz, BYPASS	Adjusts the frequency above which sound fed back to the effect will be cut. If you do not want to cut the high frequencies, set this parameter to BYPASS.
Delay Balance	D100:0W–D0:100W	Adjusts the volume balance between the sound that is sent through the delay (W) and the sound that is not sent through the delay (D).
Level	0–127	Output Level

### 76: Flanger → Delay

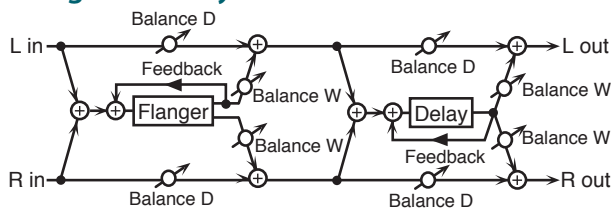

Parameter	Value	Explanation
Flanger Pre Delay	0.0–100 msec	Adjusts the delay time from when the direct sound begins until the flanger sound is heard.
Flanger Rate	0.05–10.00 Hz, note	Frequency of modulation
Flanger Depth	0–127	Depth of modulation
Flanger Feedback	-98–+98 %	Adjusts the proportion of the flanger sound that is fed back into the effect. Negative (-) settings will invert the phase.
Flanger Balance	D100:0W–D0:100W	Volume balance between the direct sound (D) and the flanger sound (W)
Delay Time	0–2600 msec, note	Adjusts the delay time from the direct sound until the delay sound is heard.
Delay Feedback	-98–+98 %	Adjusts the proportion of the delay sound that is fed back into the effect. Negative (-) settings will invert the phase.
Delay HF Damp	200–8000 Hz, BYPASS	Adjusts the frequency above which sound fed back to the effect will be cut. If you do not want to cut the high frequencies, set this parameter to BYPASS.
Delay Balance	D100:0W–D0:100W	Adjusts the volume balance between the sound that is sent through the delay (W) and the sound that is not sent through the delay (D).
Level	0–127	Output Level

### 77: Chorus → Flanger

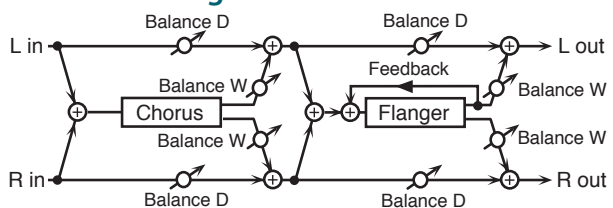

Parameter	Value	Explanation
Chorus Pre Delay	0.0–100 msec	Adjusts the delay time from the direct sound until the chorus sound is heard.
Chorus Rate	0.05–10.00 Hz, note	Modulation frequency of the chorus effect
Chorus Depth	0–127	Modulation depth of the chorus effect
Chorus Balance	D100:0W–D0:100W	Volume balance between the direct sound (D) and the chorus sound (W)
Flanger Pre Delay	0.0–100 msec	Adjusts the delay time from when the direct sound begins until the flanger sound is heard.
Flanger Rate	0.05–10.00 Hz, note	Modulation frequency of the flanger effect
Flanger Depth	0–127	Modulation depth of the flanger effect
Flanger Feedback	-98–+98 %	Adjusts the proportion of the flanger sound that is fed back into the effect. Negative (-) settings will invert the phase.

Parameter	Value	Explanation
Flanger Balance	D100:0W–D0:100W	Adjusts the volume balance between the sound that is sent through the flanger (W) and the sound that is not sent through the flanger (D).
Level	0–127	Output Level

### 78: Sympathetic Resonance

On an acoustic piano, holding down the damper pedal allows other strings to resonate in sympathy with the notes you play, creating rich and spacious resonances. This effect simulates these sympathetic resonances.

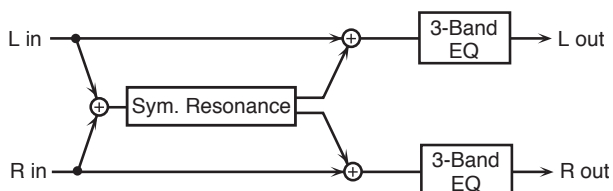

Parameter	Value	Explanation
Depth	0–127	Depth of the effect
Damper	0–127	Depth to which the damper pedal is pressed (controls the resonant sound)
Lid	1–6	This simulates the actual changes in sound that occur when the lid of a grand piano is set at different heights.
Pre LPF	16–15000 Hz, BYPASS	Frequency of the filter that cuts the high-frequency content of the input sound (BYPASS: no cut)
Pre HPF	BYPASS, 16–15000 Hz	Frequency of the filter that cuts the low-frequency content of the input sound (BYPASS: no cut)
HF Damp	16–15000 Hz, BYPASS	Frequency at which the high-frequency content of the resonant sound will be cut (BYPASS: no cut)
LF Damp	BYPASS, 16–15000 Hz	Frequency at which the low-frequency content of the resonant sound will be cut (BYPASS: no cut)
EQ Low Freq	200, 400 Hz	Frequency of the low-range EQ
EQ Low Gain	-15–+15 dB	Amount of low-range boost/cut
EQ Mid Freq	200–8000 Hz	Frequency of the midrange EQ
EQ Mid Gain	-15–+15 dB	Amount of midrange boost/cut
EQ Mid Q	0.5, 1.0, 2.0, 4.0, 8.0	Width of midrange (larger values make the region narrower)
EQ High Freq	2000, 4000, 8000 Hz	Frequency of the high-range EQ
EQ High Gain	-15–+15 dB	Amount of high-range boost/cut
Peaking Freq	200–8000 Hz	Frequency of the filter that boosts/cuts a specific frequency region of the input sound
Peaking Gain	-15–+15 dB	Amount of boost/cut produced by the filter at the specified frequency region of the input sound
Peaking Q	0.5, 1.0, 2.0, 4.0, 8.0	Width of the frequency region boosted/cut by the Peaking Gain parameter (larger values make the region narrower)
Level	0–127	Output Level

## Note

	Sixty-fourth-note triplet		Sixty-fourth note		Thirty-second-note triplet		Thirty-second note
	Sixteenth-note triplet		Dotted thirty-second note		Sixteenth note		Eighth-note triplet
	Dotted sixteenth note		Eighth note		Quarter-note triplet		Dotted eighth note
	Quarter note		Half-note triplet		Dotted quarter note		Half note
	Whole-note triplet		Dotted half note		Whole note		Double-note triplet
	Dotted whole note		Double note				

### NOTE

If you specify the delay time as a note value, slowing down the tempo will not change the delay time beyond a certain length. This is because there is an upper limit for the delay time; if the delay time is specified as a note value and you slow down the tempo until this upper limit is reached, the delay time cannot change any further. This upper limit is the maximum value that can be specified when setting the delay time as a numerical value.

## When Using 3D Effects

The following 3D effects utilize RSS (Roland Sound Space) technology to create a spaciousness that cannot be produced by delay, reverb, chorus, etc.

**52: 3D Delay**

**29: 3D Chorus**

**30: 3D Flanger**

**31: 3D Step Flanger**

When using these effects, we recommend that you place your speakers as follows. Also, make sure that the speakers are at a sufficient distance from the walls on either side.

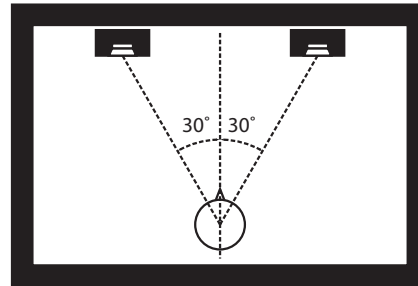

If the left and right speakers are too far apart, or if there is too much reverberation, the full 3D effect may not appear. Each of these effects has an **"Output Mode"** parameter. If the sound from the OUTPUT jacks is to be heard through speakers, set this parameter to **"Speaker."** If the sound is to be heard through headphones, set it to **"Phones."** This will ensure that the optimal 3D effect will be heard. If this parameter is not set correctly, the full 3D effect may not appear.

# MFX Parameters

The multi-effects feature 68 different kinds of effects. Some of the effects consist of two or more different effects connected in series.

Parameters marked with a sharp “#” can be controlled using a Multi-Effects Control (p. 117) (Two setting items will change simultaneously for “#1” and “#2”).

Type	MFX Name	Page
	0 Thru	–
FILTER	1 Equalizer	p. 94
	2 Spectrum	p. 94
	3 Low Boost	p. 94
	4 Step Filter	p. 94
	5 Enhancer	p. 95
	6 Auto Wah	p. 95
	7 Humanizer	p. 95
	8 Speaker Simulator	p. 95
MODULATION	9 Phaser 1	p. 96
	10 Phaser 2	p. 96
	11 Phaser 3	p. 96
	12 Step Phaser	p. 97
	13 Multi Stage Phaser	p. 97
	14 Infinite Phaser	p. 97
	15 Ring Modulator	p. 98
	16 Tremolo	p. 98
	17 Auto Pan	p. 98
	18 Slicer	p. 98
	19 Rotary 1	p. 99
	20 Rotary 2	p. 99
	21 Rotary 3	p. 100
CHORUS	22 Chorus	p. 100
	23 Flanger	p. 101
	24 Step Flanger	p. 101
	25 Hexa-Chorus	p. 102
	26 Tremolo Chorus	p. 102
	27 Space-D	p. 102
DYNAMICS	28 Overdrive	p. 102
	29 Distortion	p. 102
	30 Guitar Amp Simulator	p. 103
	31 Compressor	p. 103
	32 Limiter	p. 103
	33 Gate	p. 104
DELAY	34 Delay	p. 104
	35 Modulation Delay	p. 105
	36 3Tap Pan Delay	p. 105
	37 4Tap Pan Delay	p. 105
	38 Multi Tap Delay	p. 106
	39 Reverse Delay	p. 106
	40 Time Ctrl Delay	p. 107
LO-FI	41 LOFI Compress	p. 107
	42 Bit Crusher	p. 107
PITCH	43 Pitch Shifter	p. 107
	44 2Voice Pitch Shifter	p. 108

Type	MFX Name	Page
COMBINATION	45 Overdrive → Chorus	p. 108
	46 Overdrive → Flanger	p. 108
	47 Overdrive → Delay	p. 109
	48 Distortion → Chorus	p. 109
	49 Distortion → Flanger	p. 109
	50 Distortion → Delay	p. 109
	51 OD/DS → TouchWah	p. 109
	52 OD/DS → AutoWah	p. 110
	53 GuitarAmpSim → Chorus	p. 110
	54 GuitarAmpSim → Flanger	p. 111
	55 GuitarAmpSim → Phaser	p. 111
	56 GuitarAmpSim → Delay	p. 112
	57 EP AmpSim → Tremolo	p. 113
	58 EP AmpSim → Chorus	p. 113
	59 EP AmpSim → Flanger	p. 113
	60 EP AmpSim → Phaser	p. 114
	61 EP AmpSim → Delay	p. 114
	62 Enhancer → Chorus	p. 115
	63 Enhancer → Flanger	p. 115
	64 Enhancer → Delay	p. 115
VOCODER	65 Chorus → Delay	p. 115
	66 Flanger → Delay	p. 116
	67 Chorus → Flanger	p. 116
	68 Vocoder	p. 116

# MFX Parameters

## 01: Equalizer

This is a four-band stereo equalizer (low, mid x 2, high).

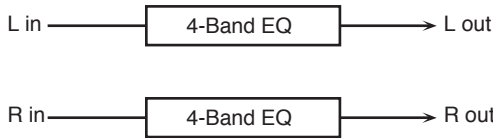

Parameter	Value	Explanation
Low Freq	200, 400 Hz	Frequency of the low range
Low Gain #	-15+15 dB	Gain of the low range
Mid1 Freq	200-8000 Hz	Frequency of the middle range 1
Mid1 Gain	-15+15 dB	Gain of the middle range 1
Mid1 Q	0.5, 1.0, 2.0, 4.0, 8.0	Width of the middle range 1 Set a higher value for Q to narrow the range to be affected.
Mid2 Freq	200-8000 Hz	Frequency of the middle range 2
Mid2 Gain	-15+15 dB	Gain of the middle range 2
Mid2 Q	0.5, 1.0, 2.0, 4.0, 8.0	Width of the middle range 2 Set a higher value for Q to narrow the range to be affected.
High Freq	2000, 4000, 8000 Hz	Frequency of the high range
High Gain #	-15+15 dB	Gain of the high range
Level #	0-127	Output Level

## 02: Spectrum

This is a stereo spectrum. Spectrum is a type of filter which modifies the timbre by boosting or cutting the level at specific frequencies.

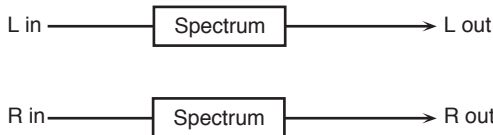

Parameter	Value	Explanation
Band1 (250 Hz)	-15+15 dB	Gain of each frequency band
Band2 (500 Hz)		
Band3 (1000 Hz)		
Band4 (1250 Hz)		
Band5 (2000 Hz)		
Band6 (3150 Hz)		
Band7 (4000 Hz)		
Band8 (8000 Hz)		
Q	0.5, 1.0, 2.0, 4.0, 8.0	Simultaneously adjusts the width of the adjusted ranges for all the frequency bands.
Level #	0-127	Output Level

## 03: Low Boost

Boosts the volume of the lower range, creating powerful lows.

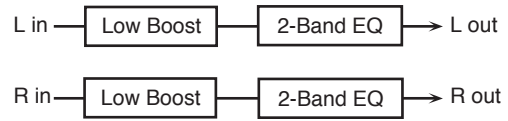

Parameter	Value	Explanation
Boost Frequency #	50-125 Hz	Center frequency at which the lower range will be boosted
Boost Gain #	0+12 dB	Amount by which the lower range will be boosted
Boost Width	WIDE, MID, NARROW	Width of the lower range that will be boosted
Low Gain	-15+15 dB	Gain of the low frequency range
High Gain	-15+15 dB	Gain of the high frequency range
Level	0-127	Output level

## 04: Step Filter

This is a filter whose cutoff frequency can be modulated in steps. You can specify the pattern by which the cutoff frequency will change.

You can use MFX CONTROL to restart the step sequence from the beginning (p. 117).



Parameter	Value	Explanation
Step 01-16	0-127	Cutoff frequency at each step
Rate #	0.05-10.00 Hz, note	Rate of modulation
Attack #	0-127	Speed at which the cutoff frequency changes between steps
Filter Type	LPF, BPF, HPF, NOTCH	Filter type Frequency range that will pass through each filter <b>LPF</b> : frequencies below the cutoff <b>BPF</b> : frequencies in the region of the cutoff <b>HPF</b> : frequencies above the cutoff <b>NOTCH</b> : frequencies other than the region of the cutoff
Filter Slope	-12, -24, -36 dB	Amount of attenuation per octave <b>-12 dB</b> : gentle <b>-24 dB</b> : steep <b>-36 dB</b> : extremely steep
Filter Resonance #	0-127	Filter resonance level Increasing this value will emphasize the region near the cutoff frequency.
Filter Gain	0+12 dB	Amount of boost for the filter output
Level	0-127	Output level

### 05: Enhancer

Controls the overtone structure of the high frequencies, adding sparkle and tightness to the sound.

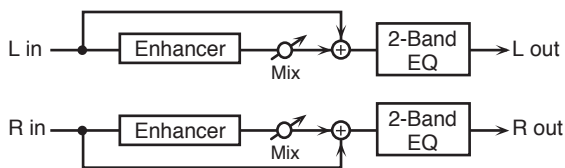

Parameter	Value	Explanation
Sens #	0-127	Sensitivity of the enhancer
Mix #	0-127	Level of the overtones generated by the enhancer
Low Gain	-15-+15 dB	Gain of the low range
High Gain	-15-+15 dB	Gain of the high range
Level	0-127	Output Level

### 06: Auto Wah

Cyclically controls a filter to create cyclic change in timbre.

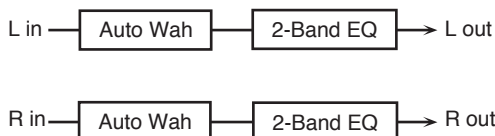

Parameter	Value	Explanation
Filter Type	LPF, BPF	Type of filter <b>LPF:</b> The wah effect will be applied over a wide frequency range. <b>BPF:</b> The wah effect will be applied over a narrow frequency range.
Manual #	0-127	Adjusts the center frequency at which the effect is applied.
Peak	0-127	Adjusts the amount of the wah effect that will occur in the range of the center frequency. Set a higher value for Q to narrow the range to be affected.
Sens #	0-127	Adjusts the sensitivity with which the filter is controlled.
Polarity	UP, DOWN	Sets the direction in which the frequency will change when the auto-wah filter is modulated. <b>UP:</b> The filter will change toward a higher frequency. <b>DOWN:</b> The filter will change toward a lower frequency.
Rate #	0.05-10.00 Hz, note	Frequency of modulation
Depth #	0-127	Depth of modulation
Phase #	0-180 deg	Adjusts the degree of phase shift of the left and right sounds when the wah effect is applied.
Low Gain	-15-+15 dB	Gain of the low range
High Gain	-15-+15 dB	Gain of the high range
Level	0-127	Output Level

### 07: Humanizer

Adds a vowel character to the sound, making it similar to a human voice.

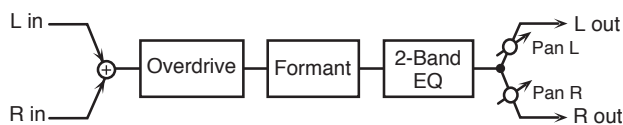

Parameter	Value	Explanation
Drive Sw	OFF, ON	Turns Drive on/off.
Drive #	0-127	Degree of distortion Also changes the volume.
Vowel1	a, e, i, o, u	Selects the vowel.
Vowel2	a, e, i, o, u	
Rate #	0.05-10.00 Hz, note	Frequency at which the two vowels switch
Depth #	0-127	Effect depth
Input Sync Sw	OFF, ON	LFO reset on/off Determines whether the LFO for switching the vowels is reset by the input signal (ON) or not (OFF).
Input Sync Threshold	0-127	Volume level at which reset is applied
Manual #	0-100	Point at which Vowel 1/2 switch <b>49 or less:</b> Vowel 1 will have a longer duration. <b>50:</b> Vowel 1 and 2 will be of equal duration. <b>51 or more:</b> Vowel 2 will have a longer duration.
Low Gain	-15-+15 dB	Gain of the low frequency range
High Gain	-15-+15 dB	Gain of the high frequency range
Pan #	L64-63R	Stereo location of the output
Level	0-127	Output level

### 08: Speaker Simulator

Simulates the speaker type and microphone settings used to record the speaker sound.

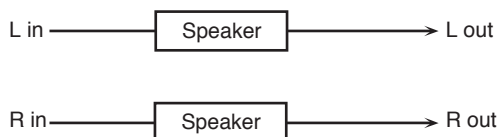

Parameter	Value	Explanation
Type	(See the following table)	Type of speaker
Mic Setting	1, 2, 3	Adjusts the location of the microphone that is recording the sound of the speaker. This can be adjusted in three steps, with the microphone becoming more distant in the order of 1, 2, and 3.
Mic Level #	0-127	Volume of the microphone
Direct Level #	0-127	Volume of the direct sound
Level #	0-127	Output Level

# MFX Parameters

## Specifications of each Speaker Type

The speaker column indicates the diameter of each speaker unit (in inches) and the number of units.

Type	Cabinet	Speaker	Microphone
SMALL 1	small open-back enclosure	10	dynamic
SMALL 2	small open-back enclosure	10	dynamic
MIDDLE	open back enclosure	12 x 1	dynamic
JC-120	open back enclosure	12 x 2	dynamic
BUILT-IN 1	open back enclosure	12 x 2	dynamic
BUILT-IN 2	open back enclosure	12 x 2	condenser
BUILT-IN 3	open back enclosure	12 x 2	condenser
BUILT-IN 4	open back enclosure	12 x 2	condenser
BUILT-IN 5	open back enclosure	12 x 2	condenser
BG STACK 1	sealed enclosure	12 x 2	condenser
BG STACK 2	large sealed enclosure	12 x 2	condenser
MS STACK 1	large sealed enclosure	12 x 4	condenser
MS STACK 2	large sealed enclosure	12 x 4	condenser
METAL STACK	large double stack	12 x 4	condenser
2-STACK	large double stack	12 x 4	condenser
3-STACK	large triple stack	12 x 4	condenser

## 09: Phaser 1

A phase-shifted sound is added to the original sound and modulated.

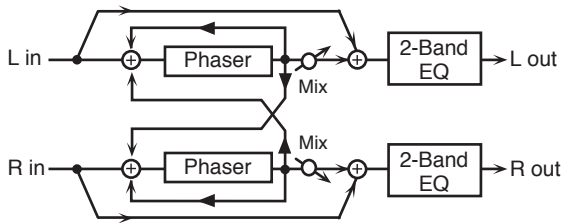

Parameter	Value	Explanation
Mode	4-STAGE, 8-STAGE, 12-STAGE	Number of stages in the phaser
Manual #	0-127	Adjusts the basic frequency from which the sound will be modulated.
Rate #	0.05-10.00 Hz, note	Frequency of modulation
Depth	0-127	Depth of modulation
Polarity	INVERSE, SYNCHRO	Selects whether the left and right phase of the modulation will be the same or the opposite. <b>INVERSE:</b> The left and right phase will be opposite. When using a mono source, this spreads the sound. <b>SYNCHRO:</b> The left and right phase will be the same. Select this when inputting a stereo source.
Resonance #	0-127	Amount of feedback
Cross Feedback	-98-+98 %	Adjusts the proportion of the phaser sound that is fed back into the effect. Negative (-) value will invert the phase.
Mix #	0-127	Level of the phase-shifted sound
Low Gain	-15-+15 dB	Gain of the low range
High Gain	-15-+15 dB	Gain of the high range
Level	0-127	Output Level

## 10: Phaser 2

This simulates an analog phaser of the past.

It is particularly suitable for electric piano.



Parameter	Value	Explanation
Rate #	0-100	Frequency of modulation
Color	1, 2	Modulation character
Low Gain	-15-+15 dB	Gain of the low range
High Gain	-15-+15 dB	Gain of the high range
Level	0-127	Output Level

## 11: Phaser 3

This simulates a different analog phaser than Phaser 2.

It is particularly suitable for electric piano.



Parameter	Value	Explanation
Speed #	0-100	Frequency of modulation
Low Gain	-15-+15 dB	Gain of the low range
High Gain	-15-+15 dB	Gain of the high range
Level	0-127	Output Level



### 12: Step Phaser

The phaser effect will be varied gradually.

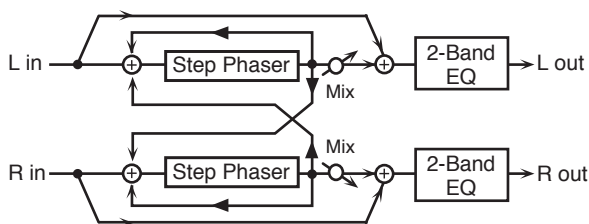

Parameter	Value	Explanation
<b>Mode</b>	4-STAGE, 8-STAGE, 12-STAGE	Number of stages in the phaser
<b>Manual #</b>	0-127	Adjusts the basic frequency from which the sound will be modulated.
<b>Rate #</b>	0.05-10.00 Hz, note	Frequency of modulation
<b>Depth</b>	0-127	Depth of modulation
<b>Polarity</b>	INVERSE, SYNCHRO	Selects whether the left and right phase of the modulation will be the same or the opposite. <b>INVERSE:</b> The left and right phase will be opposite. When using a mono source, this spreads the sound. <b>SYNCHRO:</b> The left and right phase will be the same. Select this when inputting a stereo source.
<b>Resonance #</b>	0-127	Amount of feedback
<b>Cross Feedback</b>	-98-+98 %	Adjusts the proportion of the phaser sound that is fed back into the effect. Negative (-) value will invert the phase.
<b>Step Rate #</b>	0.10-20.00 Hz, note	Rate of the step-wise change in the phaser effect
<b>Mix #</b>	0-127	Level of the phase-shifted sound
<b>Low Gain</b>	-15-+15 dB	Level of the phase-shifted sound
<b>High Gain</b>	-15-+15 dB	Gain of the high range
<b>Level</b>	0-127	Output Level

### 13: Multi Stage Phaser

Extremely high settings of the phase difference produce a deep phaser effect.

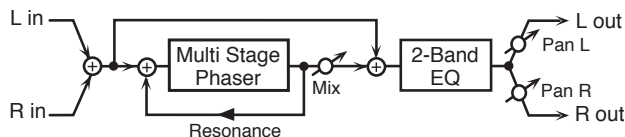

Parameter	Value	Explanation
<b>Mode</b>	4-STAGE, 8-STAGE, 12-STAGE, 16-STAGE, 20-STAGE, 24-STAGE	Number of phaser stages
<b>Manual #</b>	0-127	Adjusts the basic frequency from which the sound will be modulated.
<b>Rate #</b>	0.05-10.00 Hz, note	Frequency of modulation
<b>Depth</b>	0-127	Depth of modulation
<b>Resonance #</b>	0-127	Amount of feedback
<b>Mix #</b>	0-127	Level of the phase-shifted sound
<b>Pan #</b>	L64-63R	Stereo location of the output sound
<b>Low Gain</b>	-15-+15 dB	Gain of the low range
<b>High Gain</b>	-15-+15 dB	Gain of the high range
<b>Level</b>	0-127	Output Level

### 14: Infinite Phaser

A phaser that continues raising/lowering the frequency at which the sound is modulated.

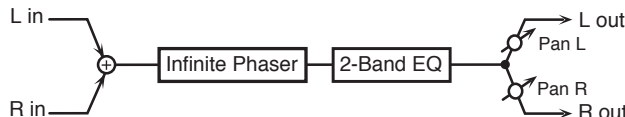

Parameter	Value	Explanation
<b>Mode</b>	1, 2, 3, 4	Higher values will produce a deeper phaser effect.
<b>Speed #</b>	-100-+100	Speed at which to raise or lower the frequency at which the sound is modulated (+: upward / -: downward)
<b>Resonance #</b>	0-127	Amount of feedback
<b>Mix #</b>	0-127	Volume of the phase-shifted sound
<b>Pan #</b>	L64-63R	Panning of the output sound
<b>Low Gain</b>	-15-+15 dB	Amount of boost/cut for the low-frequency range
<b>High Gain</b>	-15-+15 dB	Amount of boost/cut for the high-frequency range
<b>Level</b>	0-127	Output volume

## 15: Ring Modulator

This is an effect that applies amplitude modulation (AM) to the input signal, producing bell-like sounds. You can also change the modulation frequency in response to changes in the volume of the sound sent into the effect.

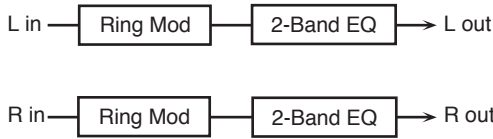

Parameter	Value	Explanation
Frequency #	0-127	Adjusts the frequency at which modulation is applied.
Sens #	0-127	Adjusts the amount of frequency modulation applied.
Polarity	UP, DOWN	Determines whether the frequency modulation moves towards higher frequencies ( <b>UP</b> ) or lower frequencies ( <b>DOWN</b> ).
Low Gain	-15-+15 dB	Gain of the low frequency range
High Gain	-15-+15 dB	Gain of the high frequency range
Balance #	D100:0W- D0:100W	Volume balance between the direct sound (D) and the effect sound (W)
Level	0-127	Output level

## 16: Tremolo

Cyclically modulates the volume to add tremolo effect to the sound.

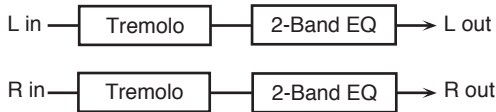

Parameter	Value	Explanation
Mod Wave	TRI, SQR, SIN, SAW1, SAW2	Modulation Wave <b>TRI</b> : triangle wave <b>SQR</b> : square wave <b>SIN</b> : sine wave <b>SAW1/2</b> : sawtooth wave
Rate #	0.05-10.00 Hz, note	Frequency of the change
Depth #	0-127	Depth to which the effect is applied
Low Gain	-15-+15 dB	Gain of the low range
High Gain	-15-+15 dB	Gain of the high range
Level	0-127	Output Level

## 17: Auto Pan

Cyclically modulates the stereo location of the sound.

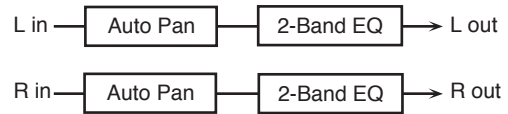

Parameter	Value	Explanation
Mod Wave	TRI, SQR, SIN, SAW1, SAW2	Modulation Wave <b>TRI</b> : triangle wave <b>SQR</b> : square wave <b>SIN</b> : sine wave <b>SAW1/2</b> : sawtooth wave
Rate #	0.05-10.00 Hz, note	Frequency of the change
Depth #	0-127	Depth to which the effect is applied
Low Gain	-15-+15 dB	Gain of the low range
High Gain	-15-+15 dB	Gain of the high range
Level	0-127	Output Level

## 18: Slicer

By applying successive cuts to the sound, this effect turns a conventional sound into a sound that appears to be played as a backing phrase. This is especially effective when applied to sustain-type sounds.

You can use MFX CONTROL to restart the step sequence from the beginning (p. 117).

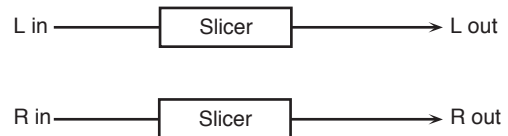

Parameter	Value	Explanation
Step 01-16	L64-63R	Level at each step
Rate #	0.05-10.00 Hz, note	Rate at which the 16-step sequence will cycle
Attack #	0-127	Speed at which the level changes between steps
Input Sync Sw	OFF, ON	Specifies whether an input note will cause the sequence to resume from the first step of the sequence (ON) or not (OFF)
Input Sync Threshold	0-127	Volume at which an input note will be detected
Mode	LEGATO, SLASH	Sets the manner in which the volume changes as one step progresses to the next. <b>LEGATO</b> : The change in volume from one step's level to the next remains unaltered. If the level of a following step is the same as the one preceding it, there is no change in volume. <b>SLASH</b> : The level is momentarily set to 0 before progressing to the level of the next step. This change in volume occurs even if the level of the following step is the same as the preceding step.

Parameter	Value	Explanation
Shuffle #	0-127	Timing of volume changes in levels for even-numbered steps (step 2, step 4, step 6...). The higher the value, the later the beat progresses.
Level	0-127	Output level

### 19: Rotary 1

This simulates a classic rotary speaker of the past.

Since the operation of the high-frequency and low-frequency rotors can be specified independently, the distinctive modulation can be reproduced realistically. This is most effective on organ tones.

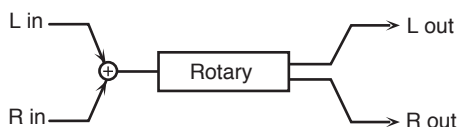

Parameter	Value	Explanation
Speed #	SLOW, FAST	Simultaneously switch the rotational speed of the low frequency rotor and high frequency rotor. <b>SLOW:</b> Slows down the rotation to the Slow Rate. <b>FAST:</b> Speeds up the rotation to the Fast Rate.
Woofers Slow Speed	0.05-10.00 Hz	Slow speed (SLOW) of the low frequency rotor
Woofers Fast Speed	0.05-10.00 Hz	Fast speed (FAST) of the low frequency rotor
Woofers Acceleration	0-15	Adjusts the time it takes the low frequency rotor to reach the newly selected speed when switching from fast to slow (or slow to fast) speed. Lower values will require longer times.
Woofers Level	0-127	Volume of the low frequency rotor
Tweeters Slow Speed	0.05-10.00 Hz	Settings of the high frequency rotor The parameters are the same as for the low frequency rotor
Tweeters Fast Speed	0.05-10.00 Hz	
Tweeters Acceleration	0-15	
Tweeters Level	0-127	
Separation	0-127	
Level #	0-127	Output Level

### 20: Rotary 2

This type provides modified response for the rotary speaker, with the low end boosted further.

This effect features the same specifications as the VK-7's built-in rotary speaker.

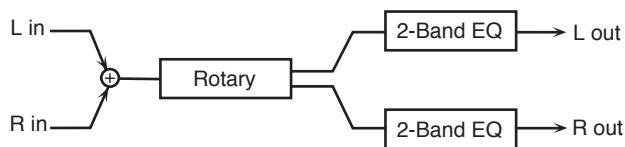

Parameter	Value	Explanation
Speed #	SLOW, FAST	Rotational speed of the rotating speaker
Brake #	OFF, ON	Switches the rotation of the rotary speaker. When this is turned on, the rotation will gradually stop. When it is turned off, the rotation will gradually resume.
Woofers Slow Speed	0.05-10.00 Hz	Low-speed rotation speed of the woofer
Woofers Fast Speed	0.05-10.00 Hz	High-speed rotation speed of the woofer
Woofers Trans Up	0-127	Adjusts the rate at which the woofer rotation speeds up when the rotation is switched from Slow to Fast.
Woofers Trans Down	0-127	Adjusts the rate at which the woofer rotation speeds up when the rotation is switched from Fast to Slow.
Woofers Level	0-127	Volume of the woofer
Tweeters Slow Speed	0.05-10.00 Hz	Settings of the tweeter The parameters are the same as for the woofer.
Tweeters Fast Speed	0.05-10.00 Hz	
Tweeters Trans Up	0-127	
Tweeters Trans Down	0-127	
Tweeters Level	0-127	
Spread	0-10	Sets the rotary speaker stereo image. The higher the value set, the wider the sound is spread out.
Low Gain	-15-+15 dB	Gain of the low range
High Gain	-15-+15 dB	Gain of the high range
Level #	0-127	Output Level

## 21: Rotary 3

This type includes an overdrive. By distorting the sound you can produce the intense organ sound used in hard rock.

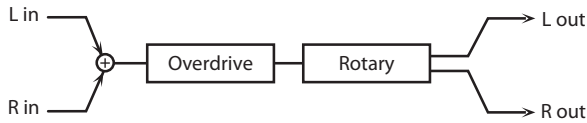

Parameter	Value	Explanation
Speed #	SLOW, FAST	Rotational speed of the rotating speaker
Brake #	OFF, ON	Switches the rotation of the rotary speaker. When this is turned on, the rotation will gradually stop. When it is turned off, the rotation will gradually resume.
OD Switch	OFF, ON	Overdrive on/off
OD Gain #	0-127	Overdrive input level. Higher values will increase the distortion.
OD Drive #	0-127	Degree of distortion
OD Level	0-127	Volume of the overdrive
Woofer Slow Speed	0.05-10.00 Hz	Low-speed rotation speed of the woofer
Woofer Fast Speed	0.05-10.00 Hz	High-speed rotation speed of the woofer
Woofer Trans Up	0-127	Adjusts the rate at which the woofer rotation speeds up when the rotation is switched from Slow to Fast.
Woofer Trans Down	0-127	Adjusts the rate at which the woofer rotation speeds up when the rotation is switched from Fast to Slow.
Woofer Level	0-127	Volume of the woofer
Tweeter Slow Speed	0.05-10.00 Hz	Settings of the tweeter. The parameters are the same as for the woofer.
Tweeter Fast Speed	0.05-10.00 Hz	
Tweeter Trans Up	0-127	
Tweeter Trans Down	0-127	
Tweeter Level	0-127	
Spread	0-10	Sets the rotary speaker stereo image. The higher the value set, the wider the sound is spread out.
Low Gain	-15-+15 dB	Gain of the low range
High Gain	-15-+15 dB	Gain of the high range
Level #	0-127	Output Level

## 22: Chorus

This is a stereo chorus. A filter is provided so that you can adjust the timbre of the chorus sound.

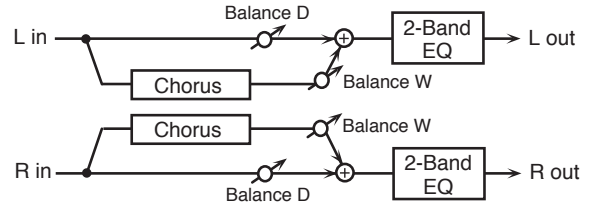

Parameter	Value	Explanation
Filter Type	OFF, LPF, HPF	Type of filter <b>OFF:</b> no filter is used <b>LPF:</b> cuts the frequency range above the Cutoff Freq <b>HPF:</b> cuts the frequency range below the Cutoff Freq
Cutoff Freq	200-8000 Hz	Basic frequency of the filter
Pre Delay	0.0-100.0 ms	Adjusts the delay time from the direct sound until the chorus sound is heard.
Rate #	0.05-10.00 Hz, note	Frequency of modulation
Depth	0-127	Depth of modulation
Phase	0-180 deg	Spatial spread of the sound
Low Gain	-15-+15 dB	Gain of the low range
High Gain	-15-+15 dB	Gain of the high range
Balance #	D100:0W-D0:100W	Volume balance between the direct sound (D) and the chorus sound (W)
Level	0-127	Output Level

### 23: Flanger

This is a stereo flanger (The LFO has the same phase for left and right). It produces a metallic resonance that rises and falls like a jet airplane taking off or landing. A filter is provided so that you can adjust the timbre of the flanged sound.

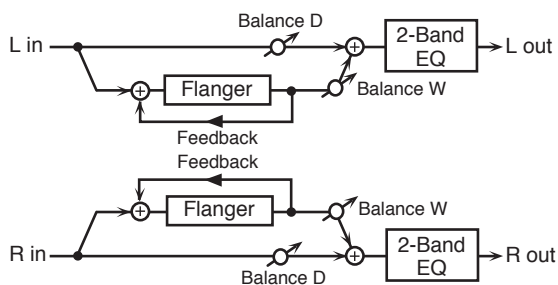

Parameter	Value	Explanation
Filter Type	OFF, LPF, HPF	Type of filter <b>OFF:</b> no filter is used <b>LPF:</b> cuts the frequency range above the Cutoff Freq <b>HPF:</b> cuts the frequency range below the Cutoff Freq
Cutoff Freq	200–8000 Hz	Basic frequency of the filter
Pre Delay	0.0–100.0 ms	Adjusts the delay time from when the direct sound begins until the flanger sound is heard.
Rate #	0.05–10.00 Hz, note	Frequency of modulation
Depth	0–127	Depth of modulation
Phase	0–180 deg	Spatial spread of the sound
Feedback #	-98–+98 %	Adjusts the proportion of the flanger sound that is fed back into the effect. Negative (-) value will invert the phase.
Low Gain	-15–+15 dB	Gain of the low range
High Gain	-15–+15 dB	Gain of the high range
Balance #	D100:0W–D0:100W	Volume balance between the direct sound (D) and the flanger sound (W)
Level	0–127	Output Level

### 24: Step Flanger

This is a flanger in which the flanger pitch changes in steps. The speed at which the pitch changes can also be specified in terms of a note-value of a specified tempo.

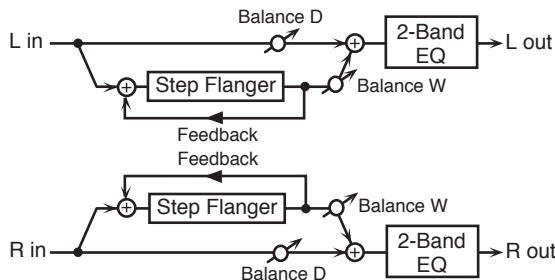

Parameter	Value	Explanation
Filter Type	OFF, LPF, HPF	Type of filter <b>OFF:</b> no filter is used <b>LPF:</b> cuts the frequency range above the Cutoff Freq <b>HPF:</b> cuts the frequency range below the Cutoff Freq
Cutoff Freq	200–8000 Hz	Basic frequency of the filter
Pre Delay	0.0–100.0 ms	Adjusts the delay time from when the direct sound begins until the flanger sound is heard.
Rate #	0.05–10.00 Hz, note	Frequency of modulation
Depth	0–127	Depth of modulation
Phase	0–180 deg	Spatial spread of the sound
Feedback #	-98–+98 %	Adjusts the proportion of the flanger sound that is fed back into the effect. Negative (-) value will invert the phase.
Step Rate #	0.10–20.00 Hz, note	Rate (period) of pitch change
Low Gain	-15–+15 dB	Gain of the low range
High Gain	-15–+15 dB	Gain of the high range
Balance #	D100:0W–D0:100W	Volume balance between the direct sound (D) and the flanger sound (W)
Level	0–127	Output Level

## 25: Hexa-Chorus

Uses a six-phase chorus (six layers of chorused sound) to give richness and spatial spread to the sound.

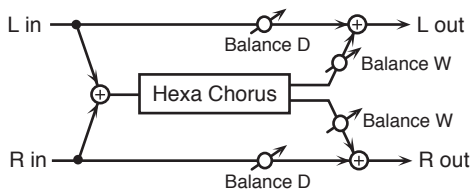

Parameter	Value	Explanation
Pre Delay	0.0–100.0 ms	Adjusts the delay time from the direct sound until the chorus sound is heard.
Rate #	0.05–10.00 Hz, note	Frequency of modulation
Depth	0–127	Depth of modulation
Pre Delay Deviation	0–20	Adjusts the differences in Pre Delay between each chorus sound.
Depth Deviation	-20–+20	Adjusts the difference in modulation depth between each chorus sound.
Pan Deviation	0–20	Adjusts the difference in stereo location between each chorus sound. <b>0:</b> All chorus sounds will be in the center. <b>20:</b> Each chorus sound will be spaced at 60 degree intervals relative to the center.
Balance #	D100:0W–D0:100W	Volume balance between the direct sound (D) and the chorus sound (W)
Level	0–127	Output Level

## 26: Tremolo Chorus

This is a chorus effect with added Tremolo (cyclic modulation of volume).

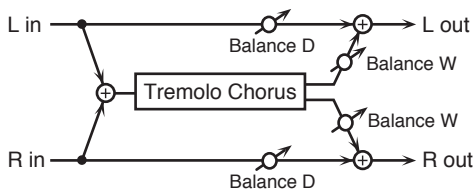

Parameter	Value	Explanation
Pre Delay	0.0–100.0 ms	Adjusts the delay time from the direct sound until the chorus sound is heard.
Chorus Rate #	0.05–10.00 Hz, note	Modulation frequency of the chorus effect
Chorus Depth	0–127	Modulation depth of the chorus effect
Tremolo Rate #	0.05–10.00 Hz, note	Modulation frequency of the tremolo effect
Tremolo Separation	0–127	Spread of the tremolo effect
Tremolo Phase	0–180 deg	Spread of the tremolo effect
Balance #	D100:0W–D0:100W	Volume balance between the direct sound (D) and the tremolo chorus sound (W)
Level	0–127	Output Level

## 27: Space-D

This is a multiple chorus that applies two-phase modulation in stereo. It gives no impression of modulation, but produces a transparent chorus effect.

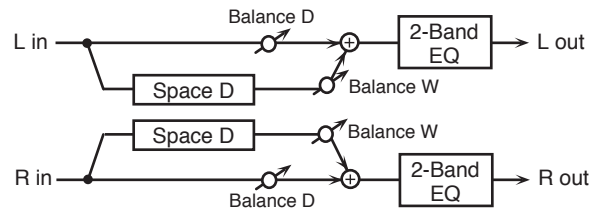

Parameter	Value	Explanation
Pre Delay	0.0–100.0 ms	Adjusts the delay time from the direct sound until the chorus sound is heard.
Rate #	0.05–10.00 Hz, note	Frequency of modulation
Depth	0–127	Depth of modulation
Phase	0–180 deg	Spatial spread of the sound
Low Gain	-15–+15 dB	Gain of the low range
High Gain	-15–+15 dB	Gain of the high range
Balance #	D100:0W–D0:100W	Volume balance between the direct sound (D) and the chorus sound (W)
Level	0–127	Output Level

## 28: Overdrive

This is an overdrive that provides heavy distortion.

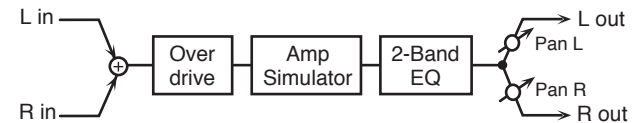

Parameter	Value	Explanation
Drive #	0–127	Degree of distortion Also changes the volume.
Tone #	0–127	Sound quality of the Overdrive effect
Amp Sw	OFF, ON	Turns the Amp Simulator on/off.
Amp Type	SMALL, BUILT-IN, 2-STACK, 3-STACK	Type of guitar amp <b>SMALL:</b> small amp <b>BUILT-IN:</b> single-unit type amp <b>2-STACK:</b> large double stack amp <b>3-STACK:</b> large triple stack amp
Low Gain	-15–+15 dB	Gain of the low range
High Gain	-15–+15 dB	Gain of the high range
Pan #	L64–63R	Stereo location of the output sound
Level	0–127	Output Level

## 29: Distortion

This is a distortion effect that provides heavy distortion. The parameters are the same as for "28: Overdrive."

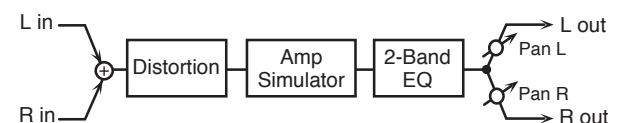

### 30: Guitar Amp Simulator

This is an effect that simulates the sound of a guitar amplifier.

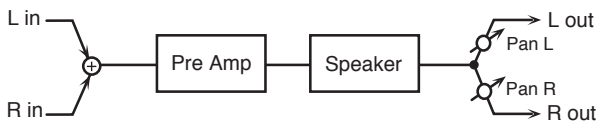

Parameter	Value	Explanation
Amp Sw	OFF, ON	Turns the amp switch on/off.
Amp Type	JC-120, CLEAN TWIN, MATCH DRIVE, BG LEAD, MS1959I, MS1959II, MS1959I+II, SLDN LEAD, METAL5150, METAL LEAD, OD-1, OD-2 TURBO, DISTORTION, FUZZ	Type of guitar amp
Amp Volume #	0-127	Volume and amount of distortion of the amp
Amp Master #	0-127	Volume of the entire pre-amp
Amp Gain	LOW, MIDDLE, HIGH	Amount of pre-amp distortion
Amp Bass	0-127	Tone of the bass/mid/treble frequency range  * Middle cannot be set if "Match Drive" is selected as the Pre Amp Type.
Amp Middle		
Amp Treble		
Amp Presence	0-127	Tone for the ultra-high frequency range
Amp Bright	OFF, ON	Turning this "On" produces a sharper and brighter sound.  * This parameter applies to the "JC-120," "Clean Twin," and "BG Lead" Pre Amp Types.
Speaker Sw	OFF, ON	Determines whether the signal passes through the speaker (ON), or not (OFF).
Speaker Type	(See the following table)	Type of speaker
Mic Setting	1, 2, 3	Adjusts the location of the microphone that's capturing the sound of the speaker.  This can be adjusted in three steps, from 1 to 3, with the microphone becoming more distant as the value increases.
Mic Level	0-127	Volume of the microphone
Direct Level	0-127	Volume of the direct sound
Pan #	L64-63R	Stereo location of the output
Level #	0-127	Output Level

#### Specifications for each Speaker Type

The speaker column indicates the diameter of each speaker unit (in inches) and the number of units.

Type	Cabinet	Speaker	Microphone
SMALL 1	small open-back enclosure	10	dynamic
SMALL 2	small open-back enclosure	10	dynamic
MIDDLE	open back enclosure	12 x 1	dynamic

Type	Cabinet	Speaker	Microphone
JC-120	open back enclosure	12 x 2	dynamic
BUILT-IN 1	open back enclosure	12 x 2	dynamic
BUILT-IN 2	open back enclosure	12 x 2	condenser
BUILT-IN 3	open back enclosure	12 x 2	condenser
BUILT-IN 4	open back enclosure	12 x 2	condenser
BUILT-IN 5	open back enclosure	12 x 2	condenser
BG STACK 1	sealed enclosure	12 x 2	condenser
BG STACK 2	large sealed enclosure	12 x 2	condenser
MS STACK 1	large sealed enclosure	12 x 4	condenser
MS STACK 2	large sealed enclosure	12 x 4	condenser
METAL STACK	large double stack	12 x 4	condenser
2-STACK	large double stack	12 x 4	condenser
3-STACK	large triple stack	12 x 4	condenser

### 31: Compressor

Flattens out high levels and boosts low levels, smoothing out fluctuations in volume.

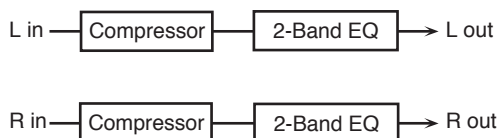

Parameter	Value	Explanation
Attack #	0-127	Sets the speed at which compression starts
Threshold #	0-127	Adjusts the volume at which compression begins
Post Gain	0-+18 dB	Adjusts the output gain.
Low Gain	-15-+15 dB	Gain of the low frequency range
High Gain	-15-+15 dB	Gain of the high frequency range
Level #	0-127	Output Level

### 32: Limiter

Compresses signals that exceed a specified volume level, preventing distortion from occurring.

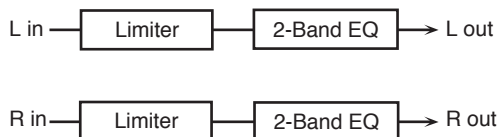

Parameter	Value	Explanation
Release #	0-127	Adjusts the time after the signal volume falls below the Threshold Level until compression is no longer applied.
Threshold #	0-127	Adjusts the volume at which compression begins
Ratio	1.5:1, 2:1, 4:1, 100:1	Compression ratio
Post Gain	0-+18 dB	Adjusts the output gain.
Low Gain	-15-+15 dB	Gain of the low frequency range
High Gain	-15-+15 dB	Gain of the high frequency range
Level #	0-127	Output Level

## 33: Gate

Cuts the reverb's delay according to the volume of the sound sent into the effect. Use this when you want to create an artificial-sounding decrease in the reverb's decay.

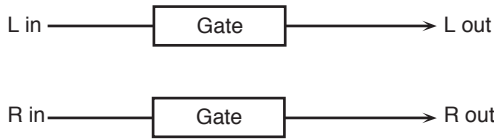

Parameter	Value	Explanation
Threshold #	0-127	Volume level at which the gate begins to close
Mode	GATE, DUCK	Type of gate <b>GATE:</b> The gate will close when the volume of the original sound decreases, cutting the original sound. <b>DUCK (Ducking):</b> The gate will close when the volume of the original sound increases, cutting the original sound.
Attack	0-127	Adjusts the time it takes for the gate to fully open after being triggered.
Hold	0-127	Adjusts the time it takes for the gate to start closing after the source sound falls beneath the Threshold.
Release	0-127	Adjusts the time it takes the gate to fully close after the hold time.
Balance #	D100:0W-D0:100W	Volume balance between the direct sound (D) and the effect sound (W)
Level	0-127	Output Level

## 34: Delay

This is a stereo delay.

**When Feedback Mode is NORMAL:**

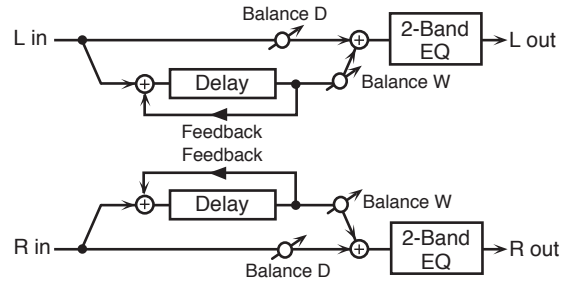

**When Feedback Mode is CROSS:**

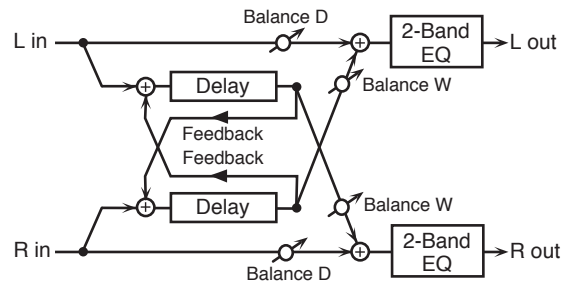

Parameter	Value	Explanation
Delay Left	0-1300 ms, note	Adjusts the time until the delay sound is heard.
Delay Right	0-1300 ms, note	Adjusts the time until the delay sound is heard.
Phase Left	NORMAL, INVERSE	Phase of the delay sound
Phase Right	NORMAL, INVERSE	Phase of the delay sound
Feedback Mode	NORMAL, CROSS	Selects the way in which delay sound is fed back into the effect (See the figures.).
Feedback #	-98-+98 %	Adjusts the amount of the delay sound that's fed back into the effect. Negative (-) value invert the phase.
HF Damp	200-8000 Hz, BYPASS	Adjusts the frequency above which sound fed back to the effect is filtered out. If you don't want to filter out any high frequencies, set this parameter to BYPASS.
Low Gain	-15-+15 dB	Gain of the low frequency range
High Gain	-15-+15 dB	Gain of the high frequency range
Balance #	D100:0W-D0:100W	Volume balance between the direct sound (D) and the delay sound (W)
Level	0-127	Output Level



### 35: Modulation Delay

Adds modulation to the delayed sound.

**When Feedback Mode is NORMAL:**

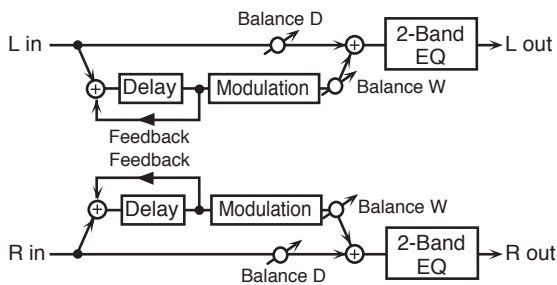

**When Feedback Mode is CROSS:**

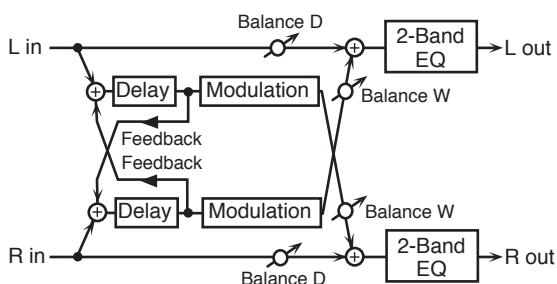

Parameter	Value	Explanation
Delay Left	0–1300 ms, note	Adjusts the time until the delay sound is heard.
Delay Right		
Feedback Mode	NORMAL, CROSS	Selects the way in which delay sound is fed back into the effect. (See the figures.)
Feedback #	-98–+98 %	Adjusts the amount of the delay sound that's fed back into the effect. Negative (-) value invert the phase.
HF Damp	200–8000 Hz, BYPASS	Adjusts the frequency above which sound fed back to the effect is filtered out. If you don't want to filter out any high frequencies, set this parameter to BYPASS.
Rate #	0.05–10.00 Hz, note	Frequency of modulation
Depth	0–127	Depth of modulation
Phase	0–180 deg	Spatial spread of the sound
Low Gain	-15–+15 dB	Gain of the low frequency range
High Gain	-15–+15 dB	Gain of the high frequency range
Balance #	D100:0W–D0:100W	Volume balance between the direct sound (D) and the delay sound (W)
Level	0–127	Output Level

### 36: 3Tap Pan Delay

Produces three delay sounds; center, left and right.

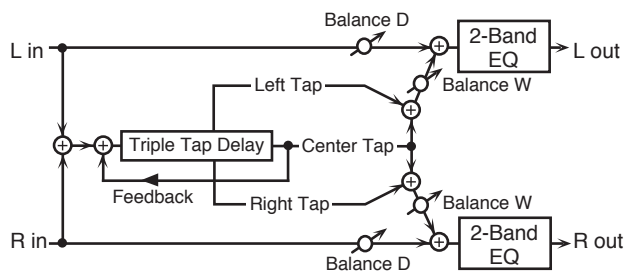

Parameter	Value	Explanation
Delay Left/Right/Center	0–2600 ms, note	Adjusts the time until the delay sound is heard.
Center Feedback #	-98–+98 %	Adjusts the amount of the delay sound that's fed back into the effect. Negative (-) value invert the phase.
HF Damp	200–8000 Hz, BYPASS	Adjusts the frequency above which sound fed back to the effect is filtered out. If you do not want to filter out any high frequencies, set this parameter to BYPASS.
Left/Right/Center Level	0–127	Volume of each delay
Low Gain	-15–+15 dB	Gain of the low frequency range
High Gain	-15–+15 dB	Gain of the high frequency range
Balance #	D100:0W–D0:100W	Volume balance between the direct sound (D) and the delay sound (W)
Level	0–127	Output Level

### 37: 4Tap Pan Delay

This effect has four delays.

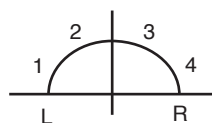
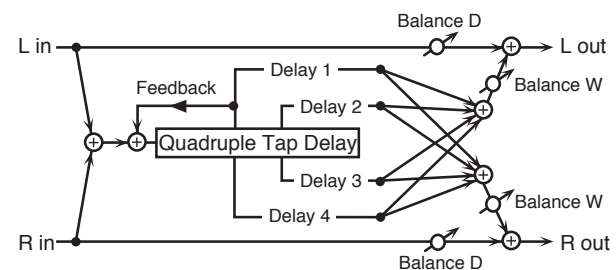

Parameter	Value	Explanation
Delay 1–4 Time	0–2600 ms, note	Adjusts the time until the delay sound is heard.
Delay 1 Feedback #	-98–+98 %	Adjusts the amount of the delay sound that's fed back into the effect. Negative (-) value invert the phase.
HF Damp	200–8000 Hz, BYPASS	Adjusts the frequency above which sound fed back to the effect is filtered out. If you do not want to filter out any high frequencies, set this parameter to BYPASS.
Delay 1–4 Level	0–127	Volume of each delay
Low Gain	-15–+15 dB	Gain of the low frequency range
High Gain	-15–+15 dB	Gain of the high frequency range
Balance #	D100:0W–D0:100W	Volume balance between the direct sound (D) and the delay sound (W)
Level	0–127	Output Level

## 38: Multi Tap Delay

This effect provides four delays. Each of the Delay Time parameters can be set to a note length based on the selected tempo. You can also set the panning and level of each delay sound.

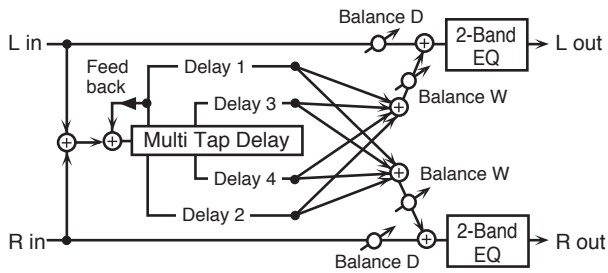

Parameter	Value	Explanation
Delay 1–4 Time	0–2600 ms, note	Adjusts the time until Delays 1–4 are heard.
Delay 1 Feedback #	-98–+98 %	Adjusts the amount of the delay sound that's fed back into the effect. Negative (-) value invert the phase.
HF Damp	200–8000 Hz, BYPASS	Adjusts the frequency above which sound fed back to the effect is filtered out. If you don't want to filter out any the high frequencies, set this parameter to BYPASS.
Delay 1–4 Pan	L64–63R	Stereo location of Delays 1–4
Delay 1–4 Level	0–127	Output level of Delays 1–4
Low Gain	-15–+15 dB	Gain of the low frequency range
High Gain	-15–+15 dB	Gain of the high frequency range
Balance #	D100:0W–D0:100W	Volume balance between the direct sound (D) and the effect sound (W)
Level	0–127	Output Level

## 39: Reverse Delay

This is a reverse delay that adds a reversed and delayed sound to the input sound. A tap delay is connected immediately after the reverse delay.

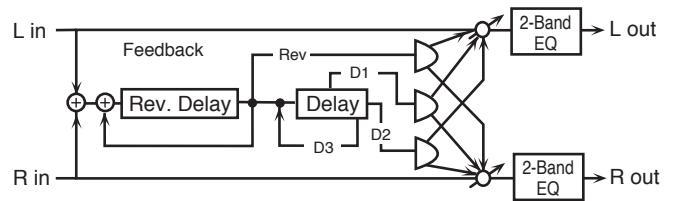

Parameter	Value	Explanation
Threshold	0–127	Volume at which the reverse delay will begin to be applied
Rev Delay Tme	0–1300 ms, note	Delay time from when sound is input into the reverse delay until the delay sound is heard
Rev Delay Feedback #	-98–+98 %	Proportion of the delay sound that is to be returned to the input of the reverse delay (negative (-) values invert the phase)
Rev Delay HF Damp	200–8000 Hz, BYPASS	Frequency at which the high-frequency content of the reverse-delayed sound will be cut (BYPASS: no cut)
Rev Delay Pan	L64–63R	Panning of the reverse delay sound
Rev Delay Level	0–127	Volume of the reverse delay sound
Delay 1–3 Time	0–1300 ms, note	Delay time from when sound is input into the tap delay until the delay sound is heard
Delay 3 Feedback #	-98–+98 %	Proportion of the delay sound that is to be returned to the input of the tap delay (negative (-) values invert the phase)
Delay HF Damp	200–8000 Hz, BYPASS	Frequency at which the low-frequency content of the tap delay sound will be cut (BYPASS: no cut)
Delay 1 Pan, Delay 2 Pan	L64–63R	Panning of the tap delay sounds
Delay 1 Level, Delay 2 Level	0–127	Volume of the tap delay sounds
Low Gain	-15–+15 dB	Amount of boost/cut for the low-frequency range
High Gain	-15–+15 dB	Amount of boost/cut for the high-frequency range
Balance #	D100:0W–D0:100W	Volume balance of the original sound (D) and delay sound (W)
Level	0–127	Output Level

### 40: Time Ctrl Delay

A stereo delay in which the delay time can be varied smoothly.

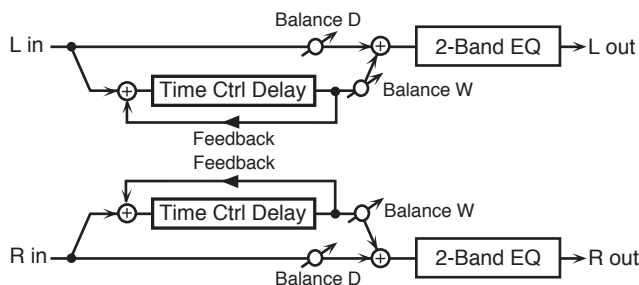

Parameter	Value	Explanation
Delay Time #	0–1300 ms, note	Adjusts the time until the delay is heard.
Acceleration	0–15	Adjusts the speed which the Delay Time changes from the current setting to a specified new setting. The rate of change for the Delay Time directly affects the rate of pitch change.
Feedback #	-98–+98 %	Adjusts the amount of the delay that's fed back into the effect. Negative (-) value invert the phase.
HF Damp	200–8000 Hz, BYPASS	Adjusts the frequency above which sound fed back to the effect is filtered out. If you do not want to filter out any high frequencies, set this parameter to BYPASS.
Low Gain	-15–+15 dB	Gain of the low frequency range
High Gain	-15–+15 dB	Gain of the high frequency range
Balance #	D100:0W–D0:100W	Volume balance between the direct sound (D) and the delay sound (W)
Level	0–127	Output Level

### 41: LOFI Compress

This is an effect that intentionally degrades the sound quality for creative purposes.

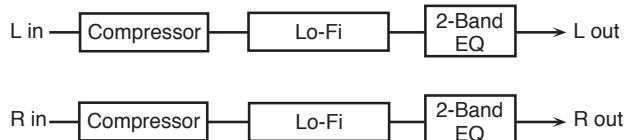

Parameter	Value	Explanation
Pre Filt Type	1–6	Selects the type of filter applied to the sound before it passes through the Lo-Fi effect. <b>1:</b> Compressor off <b>2–6:</b> Compressor on
LoFi Type	1–9	Degrades the sound quality. The sound quality grows poorer as this value is increased.
PostFilt Type	OFF, LPF, HPF	Type of filter <b>OFF:</b> no filter is used <b>LPF:</b> cuts the frequency range above the Cutoff <b>HPF:</b> cuts the frequency range below the Cutoff
PostFilt Cof	200–8000 Hz	Basic frequency of the Post Filter
Low Gain	-15–+15 dB	Gain of the low range
High Gain	-15–+15 dB	Gain of the high range
Balance #	D100:0W–D0:100W	Volume balance between the direct sound (D) and the effect sound (W)
Level #	0–127	Output Level

### 42: Bit Crusher

This creates a lo-fi sound.

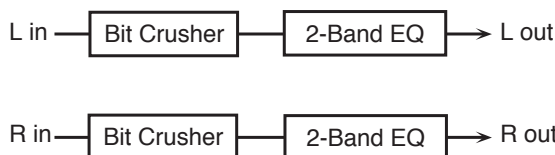

Parameter	Value	Explanation
Sample Rate #	0–127	Adjusts the sample rate.
Bit Down #	0–20	Adjusts the bit depth.
Filter #	0–127	Adjusts the filter depth.
Low Gain	-15–+15 dB	Gain of the low frequency range
High Gain	-15–+15 dB	Gain of the high frequency range
Level	0–127	Output Level

### 43: Pitch Shifter

A stereo pitch shifter.

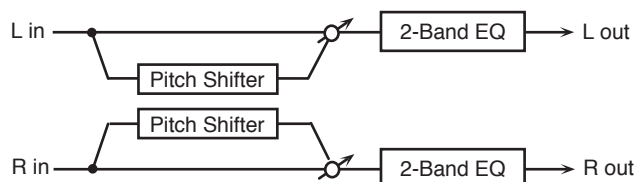

Parameter	Value	Explanation
Coarse #1	-24–+12 semi	Adjusts the pitch of the pitch shifted sound in semitone steps.
Fine #1	-100–+100 cent	Adjusts the pitch of the pitch shifted sound in 2-cent steps.
Delay Time	0–1300 ms, note	Adjusts the delay time from the direct sound until the pitch shifted sound is heard.
Feedback #	-98–+98 %	Adjusts the proportion of the pitch shifted sound that is fed back into the effect. Negative (-) value will invert the phase.
Low Gain	-15–+15 dB	Gain of the low range
High Gain	-15–+15 dB	Gain of the high range
Balance #	D100:0W–D0:100W	Volume balance between the direct sound (D) and the pitch shifted sound (W)
Level	0–127	Output Level

## 44: 2Voice Pitch Shifter

Shifts the pitch of the original sound. This 2-voice pitch shifter has two pitch shifters, and can add two pitch shifted sounds to the original sound.

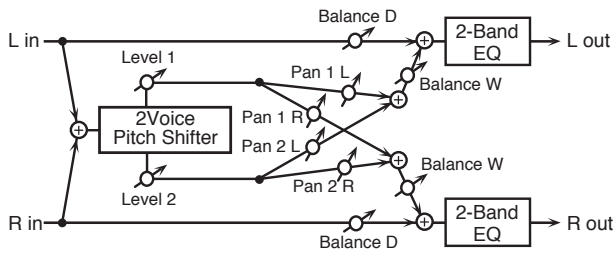

Parameter	Value	Explanation
Pitch1 Coarse #1	-24→+12 semi	Adjusts the pitch of Pitch Shift 1 in semitone steps.
Pitch1 Fine #1	-100→+100 cent	Adjusts the pitch of Pitch Shift 1 in 2-cent steps.
Pitch1 Delay	0–1300 ms, note	Adjusts the delay time from the direct sound until the Pitch Shift 1 sound is heard.
Pitch1 Feedback #	-98→+98 %	Adjusts the proportion of the pitch shifted sound that is fed back into the effect. Negative (-) value will invert the phase.
Pitch1 Pan #	L64–63R	Stereo location of the Pitch Shift 1 sound
Pitch1 Level	0–127	Volume of the Pitch Shift 1 sound
Pitch2 Coarse #2	-24→+12 semi	Settings of the Pitch Shift 2 sound. The parameters are the same as for the Pitch Shift 1 sound.
Pitch2 Fine #2	-100→+100 cent	
Pitch2 Delay	0–1300 ms, note	
Pitch2 Feedback #	-98→+98 %	
Pitch2 Pan #	L64–63R	
Pitch2 Level	0–127	
Low Gain	-15→+15 dB	Gain of the low range
High Gain	-15→+15 dB	Gain of the high range
Balance #	D100:0W–D0:100W	Volume balance between the direct sound (D) and the pitch shifted sound (W)
Level	0–127	Output Level

## 45: Overdrive → Chorus

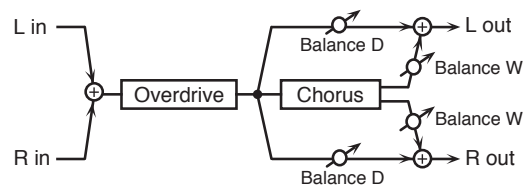

Parameter	Value	Explanation
Overdrive Drive #	0–127	Degree of distortion Also changes the volume.
Overdrive Pan #	L64–63R	Stereo location of the overdrive sound
Chorus Pre Delay	0.0–100.0 ms	Adjusts the delay time from the direct sound until the chorus sound is heard.
Chorus Rate #	0.05–10.00 Hz, note	Frequency of modulation
Chorus Depth	0–127	Depth of modulation
Chorus Balance #	D100:0W–D0:100W	Adjusts the volume balance between the sound that is sent through the chorus (W) and the sound that is not sent through the chorus (D).
Level	0–127	Output Level

## 46: Overdrive → Flanger

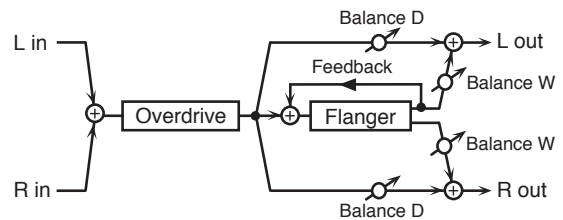

Parameter	Value	Explanation
Overdrive Drive #	0–127	Degree of distortion Also changes the volume.
Overdrive Pan #	L64–63R	Stereo location of the overdrive sound
Flanger Pre Delay	0.0–100.0 ms	Adjusts the delay time from when the direct sound begins until the flanger sound is heard.
Flanger Rate #	0.05–10.00 Hz, note	Frequency of modulation
Flanger Depth	0–127	Depth of modulation
Flanger Feedback #	-98→+98 %	Adjusts the proportion of the flanger sound that is fed back into the effect. Negative (-) value will invert the phase.
Flanger Balance #	D100:0W–D0:100W	Adjusts the volume balance between the sound that is sent through the flanger (W) and the sound that is not sent through the flanger (D).
Level	0–127	Output Level

### 47: Overdrive → Delay

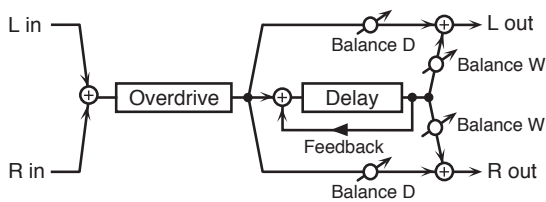

Parameter	Value	Explanation
Overdrive Drive #	0–127	Degree of distortion Also changes the volume.
Overdrive Pan #	L64–63R	Stereo location of the overdrive sound
Delay Time	0–2600 ms, note	Adjusts the delay time from the direct sound until the delay sound is heard.
Delay Feedback #	-98–+98 %	Adjusts the proportion of the delay sound that is fed back into the effect. Negative (-) value will invert the phase.
Delay HF Damp	200–8000 Hz, BYPASS	Adjusts the frequency above which sound fed back to the effect will be cut. If you do not want to cut the high frequencies, set this parameter to BYPASS.
Delay Balance #	D100:0W–D0:100W	Adjusts the volume balance between the sound that is sent through the delay (W) and the sound that is not sent through the delay (D).
Level	0–127	Output Level

### 48: Distortion → Chorus

The parameters are essentially the same as in “45: Overdrive → Chorus,” with the exception of the following two.

OD Drive → Dst Drive, OD Pan → Dst Pan

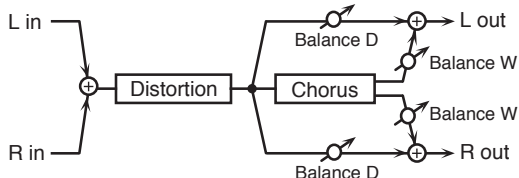

### 49: Distortion → Flanger

The parameters are essentially the same as in “46: Overdrive → Flanger,” with the exception of the following two.

OD Drive → Dst Drive, OD Pan → Dst Pan

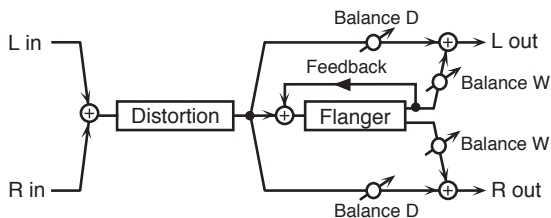

### 50: Distortion → Delay

The parameters are essentially the same as in “47: Overdrive → Delay,” with the exception of the following two.

OD Drive → Dst Drive, OD Pan → Dst Pan

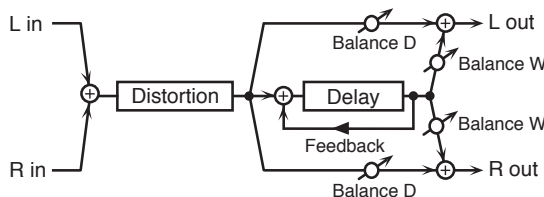

### 51: OD/DS → TouchWah

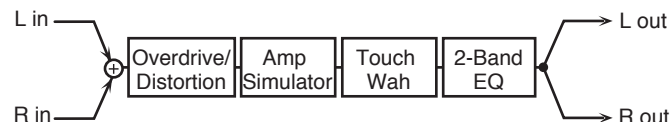

Parameter	Value	Explanation
Drive Switch	OFF, ON	Turns overdrive/distortion on/off
Drive Type	OVERDRIVE, DISTORTION	Type of distortion
Drive #	0–127	Degree of distortion Also changes the volume.
Tone #	0–127	Sound quality of the Overdrive effect
Amp Sw	OFF, ON	Turns the Amp Simulator on/off.
Amp Type	SMALL, BUILT-IN, 2-STACK, 3-STACK	Type of guitar amp <b>SMALL:</b> small amp <b>BUILT-IN:</b> single-unit type amp <b>2-STACK:</b> large double stack amp <b>3-STACK:</b> large triple stack amp
Touch Wah Switch	OFF, ON	Wah on/off
Touch Wah Filter Type	LPF, BPF	Type of filter <b>LPF:</b> Produces a wah effect in a broad frequency range. <b>BPF:</b> Produces a wah effect in a narrow frequency range.
Touch Wah Polarity	DOWN, UP	Direction in which the filter will move <b>UP:</b> Move toward a higher frequency <b>DOWN:</b> Move toward a lower frequency
Touch Wah Sens #	0–127	Sensitivity with which the filter is modified
Touch Wah Manual #	0–127	Center frequency at which the wah effect is applied
Touch Wah Peak #	0–127	Width of the frequency region at which the wah effect is applied Increasing this value will make the frequency region narrower.
Touch Wah Balance #	D100:0W–D0:100W	Volume balance of the sound that passes through the wah (W) and the unprocessed sound (D)
Low Gain	-15–+15 dB	Gain of the low range
High Gain	-15–+15 dB	Gain of the high range
Level	0–127	Output Level

# MFX Parameters

## 52: OD/DS → AutoWah

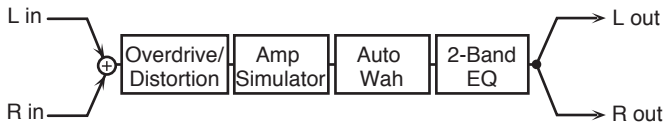

Parameter	Value	Explanation
Drive Switch	OFF, ON	Overdrive/distortion on/off
Drive Type	OVERDRIVE, DISTORTION	Type of distortion
Drive #	0–127	Degree of distortion Also changes the volume.
Tone #	0–127	Sound quality of the Overdrive effect
Amp Sw	OFF, ON	Turns the Amp Simulator on/off.
Amp Type	SMALL, BUILT-IN, 2-STACK, 3-STACK	Type of guitar amp <b>SMALL:</b> small amp <b>BUILT-IN:</b> single-unit type amp <b>2-STACK:</b> large double stack amp <b>3-STACK:</b> large triple stack amp
Auto Wah Switch	OFF, ON	Wah on/off
Auto Wah Filter Type	LPF, BPF	Type of filter <b>LPF:</b> Produces a wah effect in a broad frequency range. <b>BPF:</b> Produces a wah effect in a narrow frequency range.
Auto Wah Manual #	0–127	Center frequency at which the wah effect is applied
Auto Wah Peak #	0–127	Width of the frequency region at which the wah effect is applied Increasing this value will make the frequency region narrower.
Auto Wah Rate #	0.05–10.00 Hz, note	Rate at which the wah effect is modulated
Auto Wah Depth #	0–127	Depth at which the wah effect is modulated
Auto Wah Balance #	D100:0W–D0:100W	Volume balance of the sound that passes through the wah (W) and the unprocessed sound (D)
Low Gain	-15→+15 dB	Gain of the low range
High Gain	-15→+15 dB	Gain of the high range
Level	0–127	Output Level

## 53: GuitarAmpSim → Chorus

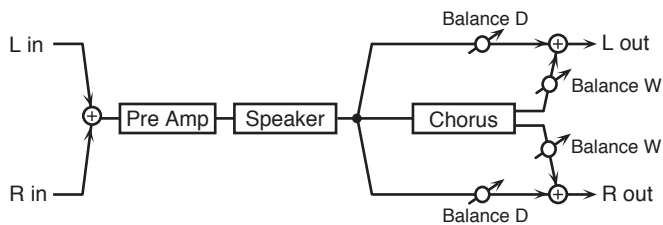

Parameter	Value	Explanation
Pre Amp Sw	OFF, ON	Turns the amp switch on/off.
Pre Amp Type	Type of guitar amp	JC-120, CLEAN TWIN, MATCH DRIVE, BG LEAD, MS1959I, MS1959II, MS1959I+II, SLDN LEAD, METAL5150, METAL LEAD, OD-1, OD-2, TURBO, DISTORTION, FUZZ
Pre Amp Volume #	0–127	Volume and amount of distortion of the amp
Pre Amp Master #	0–127	Volume of the entire pre-amp
Pre Amp Gain	LOW, MIDDLE, HIGH	Amount of pre-amp distortion
Pre Amp Bass	0–127	Tone of the bass/mid/treble frequency range  * Middle cannot be set if "Match Drive" is selected as the Pre Amp Type.
Pre Amp Middle		
Pre Amp Treble		
Chorus Switch #	OFF, ON	Chorus on/off
Chorus Pre Delay	0.0–100.0 ms	Adjusts the delay time from the direct sound until the chorus sound is heard.
Chorus Rate (Hz) #	0.05–10.00 Hz	Frequency of modulation
Chorus Depth #	0–127	Depth of modulation
Chorus Balance #	D100:0W–D0:100W	Volume balance of the sound that passes through the chorus (W) and the unprocessed sound (D)
Speaker Sw	OFF, ON	Selects whether the sound will be sent through the speaker simulation (ON) or not (OFF)
Speaker Type	(See the following table)	Type of speaker
Level	0–127	Output Level

### Specifications of each Speaker Type

The speaker column indicates the diameter of each speaker unit (in inches) and the number of units.

Type	Cabinet	Speaker	Microphone
SMALL 1	small open-back enclosure	10	dynamic
SMALL 2	small open-back enclosure	10	dynamic
MIDDLE	open back enclosure	12 x 1	dynamic
JC-120	open back enclosure	12 x 2	dynamic
BUILT-IN 1	open back enclosure	12 x 2	dynamic
BUILT-IN 2	open back enclosure	12 x 2	condenser
BUILT-IN 3	open back enclosure	12 x 2	condenser
BUILT-IN 4	open back enclosure	12 x 2	condenser
BUILT-IN 5	open back enclosure	12 x 2	condenser
BG STACK 1	sealed enclosure	12 x 2	condenser
BG STACK 2	large sealed enclosure	12 x 2	condenser
MS STACK 1	large sealed enclosure	12 x 4	condenser
MS STACK 2	large sealed enclosure	12 x 4	condenser
METAL STACK	large double stack	12 x 4	condenser
2-STACK	large double stack	12 x 4	condenser
3-STACK	large triple stack	12 x 4	condenser

### 54: GuitarAmpSim → Flanger

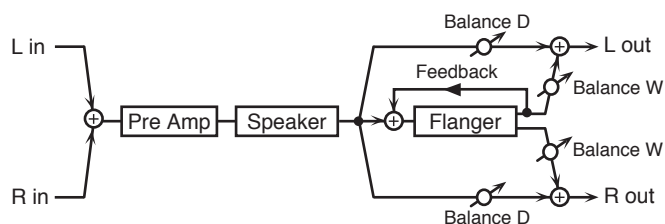

Parameter	Value	Explanation
Pre Amp Sw	OFF, ON	Turns the amp switch on/off.
Pre Amp Type	Type of guitar amp	JC-120, CLEAN TWIN, MATCH DRIVE, BG LEAD, MS1959I, MS1959II, MS1959I+II, SLDN LEAD, METAL5150, METAL LEAD, OD-1, OD-2, TURBO, DISTORTION, FUZZ
Pre Amp Volume #	0-127	Volume and amount of distortion of the amp
Pre Amp Master #	0-127	Volume of the entire pre-amp
Pre Amp Gain	LOW, MIDDLE, HIGH	Amount of pre-amp distortion
Pre Amp Bass		Tone of the bass/mid/treble frequency range
Pre Amp Middle	0-127	* Middle cannot be set if "Match Drive" is selected as the Pre Amp Type.
Pre Amp Treble		
Flanger Switch #	OFF, ON	Flanger on/off
Flanger Pre Delay	0.0-100.0 ms	Adjusts the delay time from when the direct sound begins until the flanger sound is heard.
Flanger Rate (Hz) #	0.05-10.00 Hz	Frequency of modulation
Flanger Depth #	0-127	Depth of modulation
Flanger Feedback #	-98-+98 %	Adjusts the proportion of the flanger sound that is fed back into the effect. Negative (-) value will invert the phase.
Flanger Balance #	D100:0W-D0:100W	Adjusts the volume balance between the sound that is sent through the flanger (W) and the sound that is not sent through the flanger (D).
Speaker Sw	OFF, ON	Selects whether the sound will be sent through the speaker simulation (ON) or not (OFF)
Speaker Type	(See the following table)	Type of speaker
Level	0-127	Output Level

#### Specifications of each Speaker Type

The speaker column indicates the diameter of each speaker unit (in inches) and the number of units.

Type	Cabinet	Speaker	Microphone
SMALL 1	small open-back enclosure	10	dynamic
SMALL 2	small open-back enclosure	10	dynamic
MIDDLE	open back enclosure	12 x 1	dynamic
JC-120	open back enclosure	12 x 2	dynamic
BUILT-IN 1	open back enclosure	12 x 2	dynamic
BUILT-IN 2	open back enclosure	12 x 2	condenser
BUILT-IN 3	open back enclosure	12 x 2	condenser
BUILT-IN 4	open back enclosure	12 x 2	condenser
BUILT-IN 5	open back enclosure	12 x 2	condenser
BG STACK 1	sealed enclosure	12 x 2	condenser
BG STACK 2	large sealed enclosure	12 x 2	condenser

Type	Cabinet	Speaker	Microphone
MS STACK 1	large sealed enclosure	12 x 4	condenser
MS STACK 2	large sealed enclosure	12 x 4	condenser
METAL STACK	large double stack	12 x 4	condenser
2-STACK	large double stack	12 x 4	condenser
3-STACK	large triple stack	12 x 4	condenser

### 55: GuitarAmpSim → Phaser

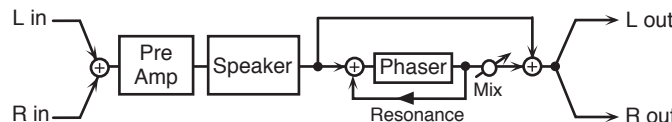

Parameter	Value	Explanation
Pre Amp Sw	OFF, ON	Turns the amp switch on/off.
Pre Amp Type	Type of guitar amp	JC-120, CLEAN TWIN, MATCH DRIVE, BG LEAD, MS1959I, MS1959II, MS1959I+II, SLDN LEAD, METAL5150, METAL LEAD, OD-1, OD-2, TURBO, DISTORTION, FUZZ
Pre Amp Volume #	0-127	Volume and amount of distortion of the amp
Pre Amp Master #	0-127	Volume of the entire pre-amp
Pre Amp Gain	LOW, MIDDLE, HIGH	Amount of pre-amp distortion
Pre Amp Bass		Tone of the bass/mid/treble frequency range
Pre Amp Middle	0-127	* Middle cannot be set if "Match Drive" is selected as the Pre Amp Type.
Pre Amp Treble		
Phaser Switch #	OFF, ON	Phaser on/off
Phaser Manual #	0-127	Center frequency at which the sound is modulated
Phaser Resonance #	0-127	Amount of feedback
Phaser Mix #	0-127	Volume of phase-shifted sound
Phaser Rate (Hz) #	0.05-10.00 Hz	Modulation rate
Phaser Depth #	0-127	Modulation depth
Speaker Sw	OFF, ON	Selects whether the sound will be sent through the speaker simulation (ON) or not (OFF)
Speaker Type	(See the following table)	Type of speaker
Level	0-127	Output Level

# MFX Parameters

## Specifications of each Speaker Type

The speaker column indicates the diameter of each speaker unit (in inches) and the number of units.

Type	Cabinet	Speaker	Microphone
SMALL 1	small open-back enclosure	10	dynamic
SMALL 2	small open-back enclosure	10	dynamic
MIDDLE	open back enclosure	12 x 1	dynamic
JC-120	open back enclosure	12 x 2	dynamic
BUILT-IN 1	open back enclosure	12 x 2	dynamic
BUILT-IN 2	open back enclosure	12 x 2	condenser
BUILT-IN 3	open back enclosure	12 x 2	condenser
BUILT-IN 4	open back enclosure	12 x 2	condenser
BUILT-IN 5	open back enclosure	12 x 2	condenser
BG STACK 1	sealed enclosure	12 x 2	condenser
BG STACK 2	large sealed enclosure	12 x 2	condenser
MS STACK 1	large sealed enclosure	12 x 4	condenser
MS STACK 2	large sealed enclosure	12 x 4	condenser
METAL STACK	large double stack	12 x 4	condenser
2-STACK	large double stack	12 x 4	condenser
3-STACK	large triple stack	12 x 4	condenser

Parameter	Value	Explanation
Speaker Type	(See the following table)	Type of speaker
Level	0-127	Output Level

## Specifications of each Speaker Type

The speaker column indicates the diameter of each speaker unit (in inches) and the number of units.

Type	Cabinet	Speaker	Microphone
SMALL 1	small open-back enclosure	10	dynamic
SMALL 2	small open-back enclosure	10	dynamic
MIDDLE	open back enclosure	12 x 1	dynamic
JC-120	open back enclosure	12 x 2	dynamic
BUILT-IN 1	open back enclosure	12 x 2	dynamic
BUILT-IN 2	open back enclosure	12 x 2	condenser
BUILT-IN 3	open back enclosure	12 x 2	condenser
BUILT-IN 4	open back enclosure	12 x 2	condenser
BUILT-IN 5	open back enclosure	12 x 2	condenser
BG STACK 1	sealed enclosure	12 x 2	condenser
BG STACK 2	large sealed enclosure	12 x 2	condenser
MS STACK 1	large sealed enclosure	12 x 4	condenser
MS STACK 2	large sealed enclosure	12 x 4	condenser
METAL STACK	large double stack	12 x 4	condenser
2-STACK	large double stack	12 x 4	condenser
3-STACK	large triple stack	12 x 4	condenser

## 56: GuitarAmpSim → Delay

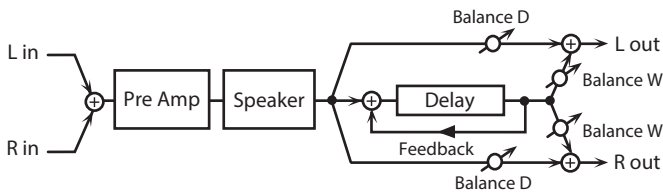

Parameter	Value	Explanation
Pre Amp Sw	OFF, ON	Turns the amp switch on/off.
Pre Amp Type	Type of guitar amp	JC-120, CLEAN TWIN, MATCH DRIVE, BG LEAD, MS1959I, MS1959II, MS1959I+II, SLDN LEAD, METAL5150, METAL LEAD, OD-1, OD-2, TURBO, DISTORTION, FUZZ
Pre Amp Volume #	0-127	Volume and amount of distortion of the amp
Pre Amp Master #	0-127	Volume of the entire pre-amp
Pre Amp Gain	LOW, MIDDLE, HIGH	Amount of pre-amp distortion
Pre Amp Bass		Tone of the bass/mid/treble frequency range
Pre Amp Middle	0-127	* Middle cannot be set if "Match Drive" is selected as the Pre Amp Type.
Pre Amp Treble		
Delay Switch #	OFF, ON	Delay on/off
Delay Time #	0-1300 ms	Adjusts the delay time from the direct sound until the delay sound is heard.
Delay Feedback #	-98-+98 %	Adjusts the proportion of the delay sound that is fed back into the effect. Negative (-) value will invert the phase.
Delay HF Damp	200-8000 Hz, BYPASS	Frequency at which the high-frequency portion of the delay sound will be cut (BYPASS: no cut)
Delay Balance #	D100:0W- D0:100W	Adjusts the volume balance between the sound that is sent through the delay (W) and the sound that is not sent through the delay (D).
Speaker Sw	OFF, ON	Selects whether the sound will be sent through the speaker simulation (ON) or not (OFF)



### 57: EP AmpSim → Tremolo

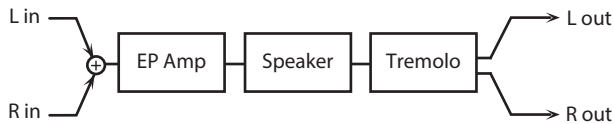

Parameter	Value	Explanation
Type	OLDCASE, NEWCASE, WURLY	Type of amp <b>OLDCASE:</b> a standard electric piano sound of the early 70s <b>NEWCASE:</b> a standard electric piano sound of the late 70s and early 80s <b>WURLY:</b> a standard electric piano sound of the 60s
Bass #	-50+50	Amount of low-frequency boost/cut
Treble #	-50+50	Amount of high-frequency boost/cut
OD Switch	OFF, ON	Overdrive on/off
OD Gain	0-127	Overdrive input level
OD Drive	0-127	Degree of distortion
Tremolo Switch #	OFF, ON	Tremolo on/off
Tremolo Rate #	0.05-10.00 Hz, note	Rate of the tremolo effect
Tremolo Depth #	0-127	Depth of the tremolo effect
Tremolo Duty	-10+10	Adjusts the duty cycle of the LFO waveform used to apply tremolo.
Speaker Type	LINE, OLD, NEW, WURLY, TWIN	Type of speaker * If LINE is selected, the sound will not be sent through the speaker simulation.
Level	0-127	Output Level

### 58: EP AmpSim → Chorus

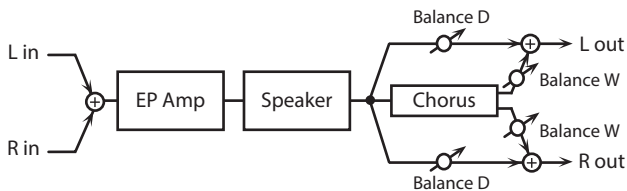

Parameter	Value	Explanation
Type	OLDCASE, NEWCASE, WURLY	Type of amp <b>OLDCASE:</b> a standard electric piano sound of the early 70s <b>NEWCASE:</b> a standard electric piano sound of the late 70s and early 80s <b>WURLY:</b> a standard electric piano sound of the 60s
Bass #	-50+50	Amount of low-frequency boost/cut
Treble #	-50+50	Amount of high-frequency boost/cut
OD Switch	OFF, ON	Overdrive on/off
OD Gain	0-127	Overdrive input level
OD Drive	0-127	Degree of distortion
Chorus Switch #	OFF, ON	Chorus on/off
Chorus Pre Delay	0.0-100.0 ms	Adjusts the delay time from the direct sound until the chorus sound is heard.
Chorus Rate #	0.05-10.00 Hz, note	Frequency of modulation
Chorus Depth #	0-127	Depth of modulation
Chorus Balance #	D100:0W-D0:100W	Volume balance of the sound that passes through the chorus (W) and the unprocessed sound (D)

Parameter	Value	Explanation
Speaker Type	LINE, OLD, NEW, WURLY, TWIN	Type of speaker * If LINE is selected, the sound will not be sent through the speaker simulation.
Level	0-127	Output Level

### 59: EP AmpSim → Flanger

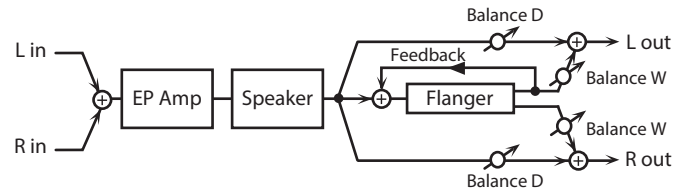

Parameter	Value	Explanation
Type	OLDCASE, NEWCASE, WURLY	Type of amp <b>OLDCASE:</b> a standard electric piano sound of the early 70s <b>NEWCASE:</b> a standard electric piano sound of the late 70s and early 80s <b>WURLY:</b> a standard electric piano sound of the 60s
Bass #	-50+50	Amount of low-frequency boost/cut
Treble #	-50+50	Amount of high-frequency boost/cut
OD Switch	OFF, ON	Overdrive on/off
OD Gain	0-127	Overdrive input level
OD Drive	0-127	Degree of distortion
Flanger Switch #	OFF, ON	Flanger on/off
Flanger Pre Delay	0.0-100.0 ms	Adjusts the delay time from when the direct sound begins until the flanger sound is heard.
Flanger Rate #	0.05-10.00 Hz, note	Frequency of modulation
Flanger Depth #	0-127	Depth of modulation
Flanger Feedback #	-98+98 %	Adjusts the proportion of the flanger sound that is fed back into the effect. Negative (-) value will invert the phase.
Flanger Balance #	D100:0W-D0:100W	Adjusts the volume balance between the sound that is sent through the flanger (W) and the sound that is not sent through the flanger (D).
Speaker Type	LINE, OLD, NEW, WURLY, TWIN	Type of speaker * If LINE is selected, the sound will not be sent through the speaker simulation.
Level	0-127	Output Level

## 60: EP AmpSim → Phaser

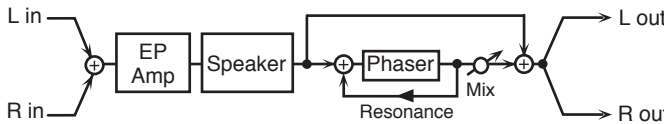

Parameter	Value	Explanation
Type	OLDCASE, NEWCASE, WURLY	Type of amp <b>OLDCASE:</b> a standard electric piano sound of the early 70s <b>NEWCASE:</b> a standard electric piano sound of the late 70s and early 80s <b>WURLY:</b> a standard electric piano sound of the 60s
Bass #	-50+50	Amount of low-frequency boost/cut
Treble #	-50+50	Amount of high-frequency boost/cut
OD Switch	OFF, ON	Overdrive on/off
OD Gain	0-127	Overdrive input level
OD Drive	0-127	Degree of distortion
Phaser Switch #	OFF, ON	Phaser on/off
Phaser Manual #	0-127	Center frequency at which the sound is modulated
Phaser Resonance #	0-127	Amount of feedback
Phaser Mix #	0-127	Volume of phase-shifted sound
Phaser Rate #	0.05-10.00 Hz, note	Modulation rate
Phaser Depth #	0-127	Modulation depth
Speaker Type	LINE, OLD, NEW, WURLY, TWIN	Type of speaker * If LINE is selected, the sound will not be sent through the speaker simulation.
Level	0-127	Output Level

## 61: EP AmpSim → Delay

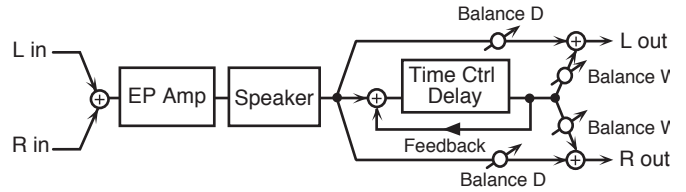

Parameter	Value	Explanation
Type	OLDCASE, NEWCASE, WURLY	Type of amp <b>OLDCASE:</b> a standard electric piano sound of the early 70s <b>NEWCASE:</b> a standard electric piano sound of the late 70s and early 80s <b>WURLY:</b> a standard electric piano sound of the 60s
Bass #	-50+50	Amount of low-frequency boost/cut
Treble #	-50+50	Amount of high-frequency boost/cut
OD Switch	OFF, ON	Overdrive on/off
OD Gain	0-127	Overdrive input level
OD Drive	0-127	Degree of distortion
Delay Switch #	OFF, ON	Delay on/off
Delay Time #	0-1300 ms, note	Adjusts the delay time from the direct sound until the delay sound is heard.
Delay Acceleration	0-15	Speed at which the current delay time changes to the specified delay time when you change the delay time. The speed of the pitch change will change simultaneously with the delay time.
Delay Feedback #	-98+98 %	Adjusts the proportion of the delay sound that is fed back into the effect. Negative (-) value will invert the phase.
Delay HF Damp	200-8000 Hz, BYPASS	Frequency at which the high-frequency portion of the delay sound will be cut (BYPASS: no cut)
Delay Balance #	D100:0W- D0:100W	Adjusts the volume balance between the sound that is sent through the delay (W) and the sound that is not sent through the delay (D).
Speaker Type	LINE, OLD, NEW, WURLY, TWIN	Type of speaker * If LINE is selected, the sound will not be sent through the speaker simulation.
Level	0-127	Output Level

### 62: Enhancer → Chorus

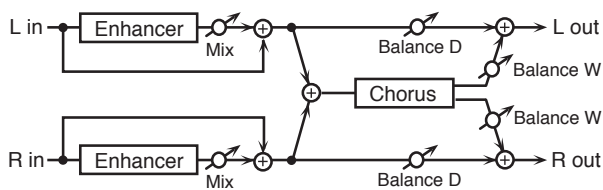

Parameter	Value	Explanation
Enhancer Sens #	0–127	Sensitivity of the enhancer
Enhancer Mix #	0–127	Level of the overtones generated by the enhancer
Chorus Pre Delay	0.0–100.0 ms	Adjusts the delay time from the direct sound until the chorus sound is heard.
Chorus Rate #	0.05–10.00 Hz, note	Frequency of modulation
Chorus Depth	0–127	Depth of modulation
Chorus Balance #	D100:0W–D0:100W	Adjusts the volume balance between the sound that is sent through the chorus (W) and the sound that is not sent through the chorus (D).
Level	0–127	Output Level

### 63: Enhancer → Flanger

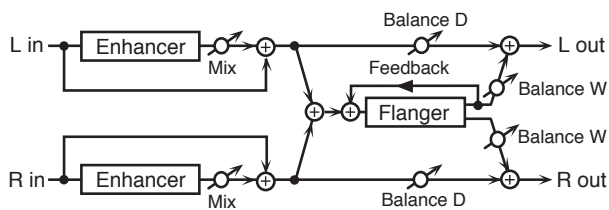

Parameter	Value	Explanation
Enhancer Sens #	0–127	Sensitivity of the enhancer
Enhancer Mix #	0–127	Level of the overtones generated by the enhancer
Flanger Pre Delay	0.0–100.0 ms	Adjusts the delay time from when the direct sound begins until the flanger sound is heard.
Flanger Rate #	0.05–10.00 Hz, note	Frequency of modulation
Flanger Depth	0–127	Depth of modulation
Flanger Feedback #	-98–+98 %	Adjusts the proportion of the flanger sound that is fed back into the effect. Negative (-) value will invert the phase.
Flanger Balance #	D100:0W–D0:100W	Adjusts the volume balance between the sound that is sent through the flanger (W) and the sound that is not sent through the flanger (D).
Level	0–127	Output Level

### 64: Enhancer → Delay

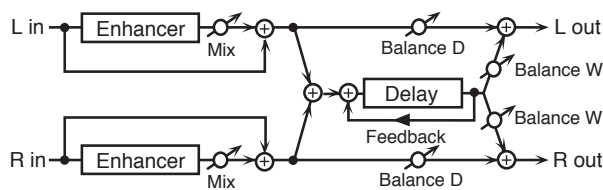

Parameter	Value	Explanation
Enhancer Sens #	0–127	Sensitivity of the enhancer
Enhancer Mix #	0–127	Level of the overtones generated by the enhancer
Delay Time	0–2600 ms, note	Adjusts the delay time from the direct sound until the delay sound is heard.
Delay Feedback #	-98–+98 %	Adjusts the proportion of the delay sound that is fed back into the effect. Negative (-) value will invert the phase.
Delay HF Damp	200–8000 Hz, BYPASS	Adjusts the frequency above which sound fed back to the effect will be cut. If you do not want to cut the high frequencies, set this parameter to BYPASS.
Delay Balance #	D100:0W–D0:100W	Adjusts the volume balance between the sound that is sent through the delay (W) and the sound that is not sent through the delay (D).
Level	0–127	Output Level

### 65: Chorus → Delay

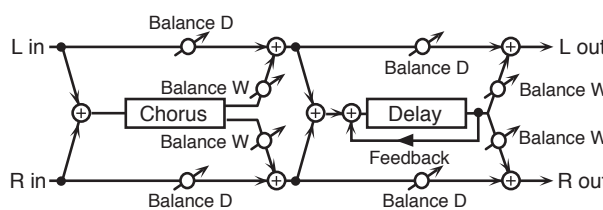

Parameter	Value	Explanation
Chorus Pre Delay	0.0–100.0 ms	Adjusts the delay time from the direct sound until the chorus sound is heard.
Chorus Rate #	0.05–10.00 Hz, note	Frequency of modulation
Chorus Depth	0–127	Depth of modulation
Chorus Balance #	D100:0W–D0:100W	Volume balance between the direct sound (D) and the chorus sound (W)
Delay Time	0–2600 ms, note	Adjusts the delay time from the direct sound until the delay sound is heard.
Delay Feedback #	-98–+98 %	Adjusts the proportion of the delay sound that is fed back into the effect. Negative (-) value will invert the phase.
Delay HF Damp	200–8000 Hz, BYPASS	Adjusts the frequency above which sound fed back to the effect will be cut. If you do not want to cut the high frequencies, set this parameter to BYPASS.
Delay Balance #	D100:0W–D0:100W	Adjusts the volume balance between the sound that is sent through the delay (W) and the sound that is not sent through the delay (D).
Level	0–127	Output Level

## 66: Flanger → Delay

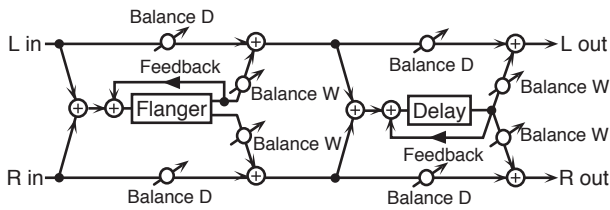

Parameter	Value	Explanation
Flanger Pre Delay	0.0–100.0 ms	Adjusts the delay time from when the direct sound begins until the flanger sound is heard.
Flanger Rate #	0.05–10.00 Hz, note	Frequency of modulation
Flanger Depth	0–127	Depth of modulation
Flanger Feedback #	–98–+98 %	Adjusts the proportion of the flanger sound that is fed back into the effect. Negative (-) value will invert the phase.
Flanger Balance #	D100:0W–D0:100W	Volume balance between the direct sound (D) and the flanger sound (W)
Delay Time	0–2600 ms, note	Adjusts the delay time from the direct sound until the delay sound is heard.
Delay Feedback #	–98–+98 %	Adjusts the proportion of the delay sound that is fed back into the effect. Negative (-) value will invert the phase.
Delay HF Damp	200–8000 Hz, BYPASS	Adjusts the frequency above which sound fed back to the effect will be cut. If you do not want to cut the high frequencies, set this parameter to BYPASS.
Delay Balance #	D100:0W–D0:100W	Adjusts the volume balance between the sound that is sent through the delay (W) and the sound that is not sent through the delay (D).
Level	0–127	Output Level

## 68: Vocoder

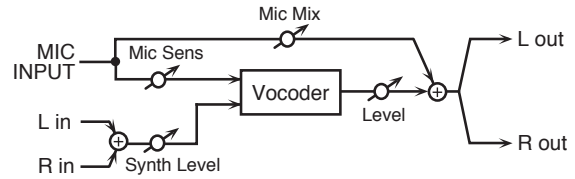

Parameter	Value	Explanation
Mic Sens #	0–127	Input sensitivity of the microphone
Synth Level #	0–127	Input level of the instrument
Mic Mix #	0–127	Amount of microphone audio added to the output of the vocoder
Level	0–127	Volume level after passing through the vocoder

## Note

## 67: Chorus → Flanger

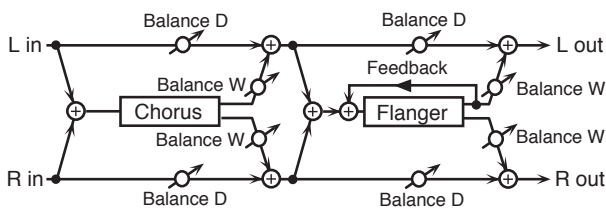

Parameter	Value	Explanation
Chorus Pre Delay	0.0–100.0 ms	Adjusts the delay time from the direct sound until the chorus sound is heard.
Chorus Rate #	0.05–10.00 Hz, note	Modulation frequency of the chorus effect
Chorus Depth	0–127	Modulation depth of the chorus effect
Chorus Balance #	D100:0W–D0:100W	Volume balance between the direct sound (D) and the chorus sound (W)
Flanger Pre Delay	0.0–100.0 ms	Adjusts the delay time from when the direct sound begins until the flanger sound is heard.
Flanger Rate #	0.05–10.00 Hz, note	Modulation frequency of the flanger effect
Flanger Depth	0–127	Modulation depth of the flanger effect
Flanger Feedback #	–98–+98 %	Adjusts the proportion of the flanger sound that is fed back into the effect. Negative (-) value will invert the phase.
Flanger Balance #	D100:0W–D0:100W	Adjusts the volume balance between the sound that is sent through the flanger (W) and the sound that is not sent through the flanger (D).
Level	0–127	Output Level

## About the STEP RESET Function

- 04: Step Filter
- 18: Slicer

The above types contain a sixteen-step sequencer. For these types, you can use a MFX CONTROL to reset the sequence to play from the first step. To do this, set the MFX CONTROL Destination to “**Step Reset.**”

For example if you are using the modulation lever to control the effect, you would make the following settings.

Parameter	Value
Source	CC01: Modulation
Destination	Step Reset
Sens	+63

With these settings, the sequence will play back from the first step whenever you operate the modulation lever.

## Controlling a MFX via MIDI (MFX CONTROL)

You can use MIDI messages such as control change messages to control the principal MFX parameters. This capability is called “**MFX CONTROL (multi-effects control).**”

The parameters that can be controlled are preset for each MFX type, and are the parameters marked by a “#” symbol in the following explanations of each MFX parameter. Up to four multi-effects control settings can be assigned using MFX 1–16.

To use MFX CONTROL, you’ll need to specify which MIDI message (Source) will affect which parameter (Destination), and how greatly (Sens).

Parameter	Value	Explanation
Source (1–4)		Specifies the MIDI message that will control the corresponding MFX CONTROL parameter.
	OFF	MFX will not be used.
	CC01–31	Controller number 1–31
	CC33–95	Controller number 33–95
	PITCH BEND	Pitch bend
	AFTERTOUCH	Aftertouch
	SYS CTRL1–4	Use the controller that is assigned by the System Parameter setting System Control 1–4 Source.
Destination (1–4)	Refer to the parameters marked “#” on p. 94 and following	Selects the multi-effect parameter that will be controlled by control source 1–4.  The type of parameters that can be selected will depend on the type of multi-effect you’ve selected in MFX Type.
Sens (1–4)	-63– +63	Specifies the depth of MFX CONTROL. Specify a positive (+) value if you want to change the value of the assigned destination in a positive direction (larger, toward the right, faster, etc.), or specify a negative (-) value if you want to change the value in a negative direction (smaller, toward the left, slower, etc.). Larger values will allow a greater amount of control.

# SuperNATURAL Tone CC Assign

## SuperNATURAL Acoustic (SN-A)

Inst			CC16	CC17	CC18	CC19
No.	Name	Category				
1	Concert Grand	Ac. Piano	-	-	-	-
2	Grand Piano1	Ac. Piano	-	-	-	-
3	Grand Piano2	Ac. Piano	-	-	-	-
4	Grand Piano3	Ac. Piano	-	-	-	-
5	Mellow Piano	Ac. Piano	-	-	-	-
6	Bright Piano	Ac. Piano	-	-	-	-
7	Upright Piano	Ac. Piano	-	-	-	-
8	Concert Mono	Ac. Piano	-	-	-	-
9	Honky-tonk	Ac. Piano	-	-	-	-
10	Pure Vintage EP1	E. Piano	Noise Level	-	-	-
11	Pure Vintage EP2	E. Piano	Noise Level	-	-	-
12	Pure Wurlly	E. Piano	Noise Level	-	-	-
13	Pure Vintage EP3	E. Piano	Noise Level	-	-	-
14	Old Hammer EP	E. Piano	Noise Level	-	-	-
15	Dyno Piano	E. Piano	Noise Level	-	-	-
16	Clav CB Flat	Other Keyboards	Noise Level	-	-	-
17	Clav CA Flat	Other Keyboards	Noise Level	-	-	-
18	Clav CB Medium	Other Keyboards	Noise Level	-	-	-
19	Clav CA Medium	Other Keyboards	Noise Level	-	-	-
20	Clav CB Brillia	Other Keyboards	Noise Level	-	-	-
21	Clav CA Brillia	Other Keyboards	Noise Level	-	-	-
22	Clav CB Combo	Other Keyboards	Noise Level	-	-	-
23	Clav CA Combo	Other Keyboards	Noise Level	-	-	-
24	TW Organ	Organ	Noise Level *1	-	-	-
25	Nylon Guitar	Ac. Guitar	Noise Level	Strum Speed	-	Strum Mode
26	SteelStr Guitar	Ac. Guitar	Noise Level	Strum Speed	-	Strum Mode
27	Acoustic Bass	Ac. Bass	Noise Level	-	-	-
28	Fingered Bass	E. Bass	Noise Level	-	-	-
29	Picked Bass	E. Bass	Noise Level	-	-	-
30	Strings	Strings	-	-	-	HoldLegato Mode
31	Marcato Strings	Strings	-	-	-	HoldLegato Mode

\*1 Offset value relative to the Inst tab parameters KeyOn (Off) ClickLevel and LeakageLevel

\*2 This can always be controlled by CC01 regardless of the SYS\_CTRL1 setting.

\*3 Follows the SYS\_CTRL1 setting. If the Control Source Select parameter is set to SYSTEM, the System Control Src1 is used for SYS\_CTRL1. If the Control Source Select parameter is set to STUDIO SET, then the Tone Control Src1 is used. In both cases, the factory setting is CC01.

\*4 If the Control Source Select parameter is set to SYSTEM, the System Control Src2 setting is used for SYS\_CTRL2. If the Control Source Select parameter is set to STUDIO SET, the Tone Control Src2 setting is used. In both cases, the factory setting is AFTERTOUC.

Inst		CC80	CC81	CC82	CC65	CC01 (SYS_CTRL1) *3	AFTERTOUCHE (SYS_CTRL2) *4
No.	Name						
1	Concert Grand	-	-	-	Portamento	Vibrato *2	-
2	Grand Piano1	-	-	-	Portamento	Vibrato *2	-
3	Grand Piano2	-	-	-	Portamento	Vibrato *2	-
4	Grand Piano3	-	-	-	Portamento	Vibrato *2	-
5	Mellow Piano	-	-	-	Portamento	Vibrato *2	-
6	Bright Piano	-	-	-	Portamento	Vibrato *2	-
7	Upright Piano	-	-	-	Portamento	Vibrato *2	-
8	Concert Mono	-	-	-	Portamento	Vibrato *2	-
9	Honky-tonk	-	-	-	Portamento	Vibrato *2	-
10	Pure Vintage EP1	-	-	-	Portamento	Vibrato	-
11	Pure Vintage EP2	-	-	-	Portamento	Vibrato	-
12	Pure Wurlly	-	-	-	Portamento	Vibrato	-
13	Pure Vintage EP3	-	-	-	Portamento	Vibrato	-
14	Old Hammer EP	-	-	-	Portamento	Vibrato	-
15	Dyno Piano	-	-	-	Portamento	Vibrato	-
16	Clav CB Flat	-	-	-	Portamento	Vibrato	-
17	Clav CA Flat	-	-	-	Portamento	Vibrato	-
18	Clav CB Medium	-	-	-	Portamento	Vibrato	-
19	Clav CA Medium	-	-	-	Portamento	Vibrato	-
20	Clav CB Brillia	-	-	-	Portamento	Vibrato	-
21	Clav CA Brillia	-	-	-	Portamento	Vibrato	-
22	Clav CB Combo	-	-	-	Portamento	Vibrato	-
23	Clav CA Combo	-	-	-	Portamento	Vibrato	-
24	TW Organ	-	-	-	-	-	-
25	Nylon Guitar	Mute	Harmonics	-	Portamento	Vibrato	Vibrato
26	SteelStr Guitar	Mute	Harmonics	-	Portamento	Vibrato	Vibrato
27	Acoustic Bass	Staccato	Harmonics	-	Portamento	Vibrato	Vibrato
28	Fingered Bass	Slap	Harmonics	-	Portamento	Vibrato	Vibrato
29	Picked Bass	Bridge Mute	Harmonics	-	Portamento	Vibrato	Vibrato
30	Strings	Staccato	Pizzicato	Tremolo	Portamento	Dynamics+Vib	Level
31	Marcato Strings	Staccato	Pizzicato	Tremolo	Portamento	Dynamics+Vib	Level

## SuperNATURAL Drum (SN-D)

No.	Inst Name	CC01 (*5)
1	Studio Kick	-
2	Studio Kick 2	-
3	Studio Sn 2	Roll + Dynamics
4	Studio Sn 2 Rim	Roll + Dynamics
5	Studio Sn 2 XStk	-
6	Snare CrossStk	-
7	Rock Tom Hi	-
8	Rock Tom Mid	-
9	Rock Tom Floor	-
10	Med HH Close	-
11	Med HH Open	-
12	Med HH Pedal	-
13	Standard Rd Edge	-
14	Standard Rd Bell	-
15	Std Rd Edge/Bell	-
16	Flat 18"Ride	-
17	Standard 16"Cr R	Roll + Dynamics
18	Standard 16"Cr L	Roll + Dynamics
19	Jazz 16"Cr R	Roll + Dynamics
20	Jazz 16"Cr L	Roll + Dynamics
21	Splash Cymbal 2	-
22	China Cymbal	-
23	Tambourine 1	Roll + Dynamics
24	Cowbell 1	-
25	Vibra-slap	-
26	High Bongo 1	Roll + Dynamics
27	Low Bongo 1	-
28	MuteHi Conga 1	-
29	OpenHi Conga 1	Roll + Dynamics
30	Low Conga 1	Roll + Dynamics
31	High Timbale	-
32	Low Timbale	-
33	High Agogo 1	-
34	Low Agogo 1	-
35	Cabasa 1	-
36	Maracas 1	-
37	Short Whistle	-
38	Long Whistle	-
39	Short Guiro	-
40	Long Guiro	-
41	Claves 1	-
42	Hi WoodBlock 1	-
43	Low WoodBlock 1	-
44	Mute Cuica 1	-
45	Open Cuica 1	-
46	Mute Triangle 1	Roll + Dynamics
47	Open Triangle 1	Roll + Dynamics
48	Shaker	-
49	Sleigh Bell 1	-
50	Wind Chimes	-
51	Castanets 1	Roll + Dynamics
52	Mute Surdo 1	-
53	Open Surdo 1	-

No.	Inst Name	CC01 (*5)
54	Square Click	-
55	Metro Click	-
56	Metro Bell	-
57	High Q	-
58	Slap	-
59	Scratch Push	-
60	Scratch Pull	-
61	Applause	Dynamics

\*5 This can always be controlled by CC01 regardless of the SYS\_CTRL1 setting.