

Roland®

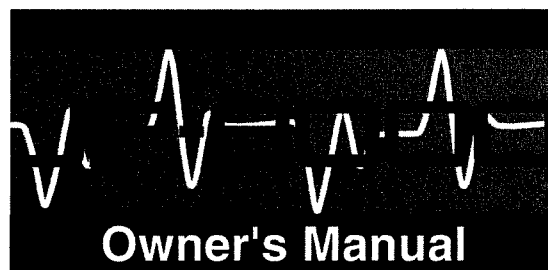



Thank you for purchasing the Roland JP-8000 Synthesizer. Before using this unit, carefully read the sections entitled: "IMPORTANT SAFETY INSTRUCTIONS" (page 2), "USING THE UNIT SAFELY" (page 3), and "IMPORTANT NOTES" (page 13).

These sections provide important information concerning the proper operation of the unit. Additionally, in order to feel assured that you have gained a good grasp of every feature provided by your new unit, this manual should be read in its entirety. The manual should be saved and kept on hand as a convenient reference.

Copyright © 1996 ROLAND CORPORATION

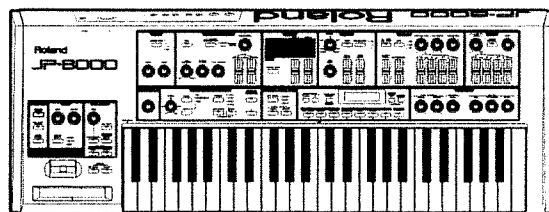
All rights reserved. No part of this publication may be reproduced in any form without the written permission of ROLAND CORPORATION.



	CAUTION RISK OF ELECTRIC SHOCK DO NOT OPEN	
ATTENTION : RISQUE DE CHOC ELECTRIQUE NE PAS OUVRIR		
CAUTION: TO REDUCE THE RISK OF ELECTRIC SHOCK, DO NOT REMOVE COVER (OR BACK). NO USER-SERVICEABLE PARTS INSIDE. REFER SERVICING TO QUALIFIED SERVICE PERSONNEL.		



The lightning flash with arrowhead symbol, within an equilateral triangle, is intended to alert the user to the presence of uninsulated "dangerous voltage" within the product's enclosure that may be of sufficient magnitude to constitute a risk of electric shock to persons.



The exclamation point within an equilateral triangle is intended to alert the user to the presence of important operating and maintenance (servicing) instructions in the literature accompanying the product.

INSTRUCTIONS PERTAINING TO A RISK OF FIRE, ELECTRIC SHOCK, OR INJURY TO PERSONS.

IMPORTANT SAFETY INSTRUCTIONS SAVE THESE INSTRUCTIONS

WARNING - When using electric products, basic precautions should always be followed, including the following:

1. Read all the instructions before using the product.
2. Do not use this product near water — for example, near a bathtub, washbowl, kitchen sink, in a wet basement, or near a swimming pool, or the like.
3. This product should be used only with a cart or stand that is recommended by the manufacturer.
4. This product, either alone or in combination with an amplifier and headphones or speakers, may be capable of producing sound levels that could cause permanent hearing loss. Do not operate for a long period of time at a high volume level or at a level that is uncomfortable. If you experience any hearing loss or ringing in the ears, you should consult an audiologist.
5. The product should be located so that its location or position does not interfere with its proper ventilation.
6. The product should be located away from heat sources such as radiators, heat registers, or other products that produce heat.
7. The product should be connected to a power supply only of the type described in the operating instructions or as marked on the product.
8. The power-supply cord of the product should be unplugged from the outlet when left unused for a long period of time.
9. Care should be taken so that objects do not fall and liquids are not spilled into the enclosure through openings.
10. The product should be serviced by qualified service personnel when:
 - A. The power-supply cord or the plug has been damaged; or
 - B. Objects have fallen, or liquid has been spilled onto the product; or
 - C. The product has been exposed to rain; or
 - D. The product does not appear to operate normally or exhibits a marked change in performance; or
 - E. The product has been dropped, or the enclosure damaged.
11. Do not attempt to service the product beyond that described in the user-maintenance instructions. All other servicing should be referred to qualified service personnel.

For the USA

GROUNDING INSTRUCTIONS

This product must be grounded. If it should malfunction or breakdown, grounding provides a path of least resistance for electric current to reduce the risk of electric shock.

This product is equipped with a cord having an equipment-grounding conductor and a grounding plug. The plug must be plugged into an appropriate outlet that is properly installed and grounded in accordance with all local codes and ordinances.

DANGER: Improper connection of the equipment-grounding conductor can result in a risk of electric shock. Check with a qualified electrician or serviceman if you are in doubt as to whether the product is properly grounded. Do not modify the plug provided with the product — if it will not fit the outlet, have a proper outlet installed by a qualified electrician.

For the U.K.

WARNING: THIS APPARATUS MUST BE EARTHED
IMPORTANT: THE WIRES IN THIS MAINS LEAD ARE COLOURED IN ACCORDANCE WITH THE FOLLOWING CODE.
 GREEN-AND-YELLOW: EARTH, BLUE: NEUTRAL, BROWN: LIVE

As the colours of the wires in the mains lead of this apparatus may not correspond with the coloured markings identifying the terminals in your plug, proceed as follows:

The wire which is coloured GREEN-AND-YELLOW must be connected to the terminal in the plug which is marked by the letter E or by the safety earth symbol  or coloured GREEN or GREEN-AND-YELLOW.

The wire which is coloured BLUE must be connected to the terminal which is marked with the letter N or coloured BLACK.



The wire which is coloured BROWN must be connected to the terminal which is marked with the letter L or coloured RED.

The product which is equipped with a THREE WIRE GROUNDING TYPE LINE PLUG must be grounded.







USING THE UNIT SAFELY

INSTRUCTIONS FOR THE PREVENTION OF FIRE, ELECTRIC SHOCK, OR INJURY TO PERSONS

About WARNING and CAUTION Notices







 WARNING	Used for instructions intended to alert the user to the risk of death or severe injury should the unit be used improperly.
 CAUTION	Used for instructions intended to alert the user to the risk of injury or material damage should the unit be used improperly. * Material damage refers to damage or other adverse effects caused with respect to the home and all its furnishings, as well to domestic animals or pets.

About the Symbols







	The  symbol alerts the user to important instructions or warnings. The specific meaning of the symbol is determined by the design contained within the triangle. In the case of the symbol at left, it is used for general cautions, warnings, or alerts to danger.
	The  symbol alerts the user to items that must never be carried out (are forbidden). The specific thing that must not be done is indicated by the design contained within the circle. In the case of the symbol at left, it means that the unit must never be disassembled.
	The  symbol alerts the user to things that must be carried out. The specific thing that must be done is indicated by the design contained within the circle. In the case of the symbol at left, it means that the power-cord must be unplugged from the outlet.

ALWAYS OBSERVE THE FOLLOWING

WARNING

- Before using this unit, make sure to read the instructions below, and the Owner's Manual. 
- Do not open or perform any internal modifications on the unit. 
- Avoid damaging the power cord. Do not bend it excessively, step on it, place heavy objects on it, etc. A damaged cord can easily become a shock or fire hazard. Never use a power cord after it has been damaged. 
- In households with small children, an adult should provide supervision until the child is capable of following all the rules essential for the safe operation of the unit. 
- Protect the unit from strong impact. (Do not drop it!) 
- Do not force the unit's power-supply cord to share an outlet with an unreasonable number of other devices. Be especially careful when using extension cords—the total power used by all devices you have connected to the extension cord's outlet must never exceed the power rating (watts/amperes) for the extension cord. Excessive loads can cause the insulation on the cord to heat up and eventually melt through. 
- Before using the unit in a foreign country, consult with your dealer, or qualified Roland service personnel. 

CAUTION

- Always grasp only the plug on the power-supply cord when plugging into, or unplugging from, an outlet or this unit. 
- Try to prevent cords and cables from becoming entangled. Also, all cords and cables should be placed so they are out of the reach of children. 
- Never climb on top of, nor place heavy objects on the unit. 
- Never handle the power cord or its plugs with wet hands when plugging into, or unplugging from, an outlet or this unit. 
- Before moving the unit, disconnect the power plug from the outlet, and pull out all cords from external devices. 
- Before cleaning the unit, turn off the power and unplug the power cord from the outlet (p. 17). 
- Whenever you suspect the possibility of lightning in your area, pull the plug on the power cord out of the outlet. 

Contents

Using the Unit Safely	3
Main Features.....	8
How to Read This Manual.....	9
Front and Rear Panel	10
Important Notes.....	13
Printing Conventions in This Manual	14

Quick Start

Step 1. Playing the Sounds

Connections.....	16
Turning on the Power.....	17
■ Turning off the Power	17
Restoring the Factory Settings (Initialize).....	18
Listening to the Demo Songs	19
Playing the Sounds	20

Step 2. Modifying the Sound

Using "Waveform" to Modify the Waveform	21
Using "Cutoff Frequency" to make the sound brighter/darker.....	22
Using "Resonance" to Add Character to the Sound.....	23
Using "LFO 1" to Add Modulation to the Sound	24
Using "Tone Control" to adjust the tone.....	25
Using "Chorus" to Broaden the Sound.....	26
Using "Delay" to Add Echo to the Sound	26
Storing a Performance	27

Step 3. Shortcuts! Convenient Functions of the JP-8000

Adjusting Many Sliders at Once (Ribbon Controller).....	30
Producing Arpeggios when Chords are Played (Arpeggiator).....	32
Playing Patterns with One Finger (RPS)	34
■ Preparing to Create Patterns (Pattern Clear)	35
■ Creating a Pattern	36
■ If You Make a Mistake While Recording.....	38
Easily Controlling Complex Tonal Changes (Motion Control)	40
■ Preparing to Record a Motion (Clearing a Motion)	41
■ Recording a Motion	42
■ If You Make a Mistake While Recording.....	44
Playing Two Sounds at Once (Key Mode)	45
■ Playing Just One Patch (Single)	45
■ Playing Two Patches From Each Key (Dual)	46
■ Playing Different Patches in the Left and Right Keyboard Areas (Split)	46

Advanced Use

Chapter 1. Overview of the JP-8000

How the JP-8000 is Organized	48
Patches and Performances	48
About Memory	50

Chapter 2. Patch Editing Procedure

Selecting a Patch	52
Editing a Patch	52
■ Edit while viewing the slider/knob values	52
■ Checking the current value of a parameter (Temporary Scope)	53
■ Resetting the Sound to the Panel Settings (Manual)	53
Storing a Patch	54

Chapter 3. Functions that Modify the Sound

Selecting the Basic Waveform for the Sound (1) (Oscillator 1)	55
Selecting the Basic Waveform for the Sound (2) (Oscillator 2)	57
Modifying the Waveform and Pitch of the Sound (Oscillator Common)	58
Modifying the Brightness (Filter)	59
Modifying the Volume (Amplifier)	62
Modulating the Sound (LFO 1)	63
Modifying the Tone (Tone Control)	64
Adding Spaciousness and Depth to the Sound (Chorus)	64
Adding an Echo Effect (Delay)	65

Chapter 4. Taking Advantage of the Performance Functions

Controlling Multiple Parameters Simultaneously (Ribbon Controller)	66
■ Ribbon Controller Settings	66
■ Using the Ribbon Controller to Change the Pitch	67
■ Changing the Way the Sound is Controlled (Relative)	67
■ Sustaining the Change in the Sound (Hold)	67
■ Canceling the Settings of a Parameter	67
■ Canceling the Settings of All Parameters	68
Using Keyboard Dynamics to Affect Parameters (Velocity)	68
■ Velocity On/Off	68
■ Velocity Settings	68
■ Canceling the Settings of a Parameter	69
■ Canceling the Settings of All Parameters	69
Playing Single Notes (Mono/Legato)	70
■ Mono On/Off	70
■ Switching Mono/Legato	70
Smoothly Changing the Pitch Between Notes (Portamento)	70
■ Portamento On/Off	70
■ Setting the Duration of the Pitch Change (Portamento Time)	71

Playing in a Range Beyond the Keyboard (Oscillator Shift / Keyboard Shift)	71
■ Oscillator Shift	71
■ Keyboard Shift	71
Transposing your Performance (Part Transpose)	72
■ Part Transpose Settings	72
Changing the Pitch (Pitch Bend Lever)	72
■ Bend Range Settings	72
■ Canceling the Bend Range Setting.....	73
Adding Cyclic Change (Modulation Lever (LFO 2))	73
■ Selecting the Object of Setting the Modulation Depth (Depth Select)	73
■ Setting the Modulation Depth (Depth).....	73
■ Setting the Modulation Speed (Rate)	74
Using a Pedal to Control Your Performance (Control Pedal)	74
■ Pedal Settings	74
Sustaining the Sound (Hold Pedal)	74

Chapter 5. Playing Arpeggios and Original Patterns (Arpeggiator/RPS)

Playing Arpeggios (Arpeggiator)	75
■ Arpeggiator Settings.....	75
■ Changing the Beat of the Arpeggio (Arpeggio Beat Pattern)	76
■ Selecting the Part for Arpeggiation in Dual Mode (Arpeggio Destination).....	76
Playing Original Patterns with One Finger (RPS)	76
■ Setting the Timing at Which Patterns Will Switch (Pattern Trigger Quantize).....	77
■ Settings for Recording	77
■ Recording a Pattern	78
■ Erasing Unwanted Notes.....	79
■ Copying a Pattern	80
■ Erasing a Pattern	80

Chapter 6. Recording Slider/knob Movements (Motion Control)

Playing Back a Motion	81
■ Moving Sliders or Knobs While Playing Back Motions	81
■ Playing Back a Motion From the Beginning Each Time a Key is Pressed (Motion Restart)	82
■ Switching Motion Sets.....	82
Recording a Motion	83
■ Settings for Recording	83
■ Recording a Motion	83
■ Erasing the Movement of a Slider or a Knob.....	84
■ Erasing a Motion	84

Chapter 7. Performance/System Settings

Making Performance/System Parameter settings	85
Performance Parameter Functions	85
■ Settings for the Entire Performance (Performance Common).....	85
■ Settings for Each Part (Performance Part)	86
■ Starting an Individual Envelope While a Key Remains Pressed (Individual Trigger).....	88

System Parameter Functions	89
■ MIDI Settings (1) (MIDI Parameters)	89
■ MIDI Settings (2) (MIDI Switch)	89
■ Tuning / Other Settings (Setup)	90

Chapter 8. Restoring the Factory Settings (Initialize)

■ Procedure	91
■ Types of Initialization	91

Chapter 9. Using MIDI

Controlling External MIDI Devices	93
■ Playing External MIDI Sound Sources	93
■ Selecting Sounds on an External MIDI Sound Source	93
Controlling the JP-8000 from an External MIDI Device	94
■ Playing the Sounds of the JP-8000	94
■ Selecting Patches on the JP-8000	94
■ Selecting Performances on the JP-8000	95
■ Using Note Messages from an External Device for Individual Trigger	95
■ Playing an arpeggio or pattern / Recording a pattern	95
Synchronizing to External MIDI Devices	95
■ Synchronizing the Arpeggio, Pattern and Motion	95
■ Synchronizing Chorus, Delay and LFO 1	96
Recording What You Play on an External Sequencer	96
■ Settings for Recording	96
■ Recording Procedure	97
Saving Settings on an External Sequencer (Bulk Dump)	97
■ Procedure	97
■ Types of Bulk Dump	98
■ Restoring Saved Settings to the JP-8000	98

Appendices

Sound-creating tips	100
Understanding Sound	104
The Basics of Sound	104
Adding Expression to Sound	106
What is MIDI?	107
MIDI Channels	107
Main MIDI Messages Used by the JP-8000	107
Troubleshooting	109
Error Messages	111
Parameter List	112
Transmit/Receive Setting List	116
MIDI Implementation	117
MIDI Implementation Chart	128
Specifications	129
Index	130
Blank Chart	134

Main Features

The JP-8000 is a synthesizer which provides not only analog simulations, but also a wide range of functions that utilize the cutting-edge of digital technology to allow real-time sound modifications and playing techniques that have never been possible until now.

■ Easy operation-----

The panel is laid out in sections similar to a conventional analog synthesizer, allowing an intuitive understanding of the parameters and operation. Since the front panel contains controllers for all sound-related parameters, you can press buttons and move sliders or knobs to make the sound change in real-time.

■ Superb performance functions -----

When playing the JP-8000, you can select one Performance from the 64 User Performances that contain settings you yourself create or from the 64 Preset Performances (which cannot be modified). This gives you a total of 128 Performances to choose from.

On the JP-8000, the Patch numbers stored in a Performance do not refer to Patches — they allow you to actually store all the Patch settings in the Performance itself. This means that when saving the Performance, it is not necessary to save the Patch settings separately. This also means that even if you rewrite the contents of a Patch that is saved in a certain Performance, other Performances that use that Patch will not be affected.

■ DSP oscillator-----

In addition to conventional waveforms (square, sawtooth, triangle), the new DSP (Digital Signal Processor) oscillator contains four types of complex waveforms that were not possible with analog technology. By controlling individual parameters for each waveform, you can create even more complex changes in the sound. Square wave, sawtooth wave, and triangle wave can also be controlled using their own parameters to create a variety of sounds.

■ Arpeggiator-----

Four types of arpeggiation are provided: UP, DOWN, UP&DOWN, and RANDOM. By changing the Beat Pattern, you can modify the accent and note duration etc., allowing you to play arpeggios in a variety of grooves.

■ RPS function for playing back your own patterns -----

RPS is a function that lets you store playback patterns that you create. The recorded patterns are assigned to individual keys of the keyboard, and can be played back simply by pressing a key.

■ Motion Control for storing slider/knob movements -----

For most of the front panel sliders and knobs, four types of motion (movement) up to 8 measures long can be recorded. By playing back these motions while you perform, you can create a variety of real-time tonal changes.

■ Ribbon Controller for dramatic tonal changes-----

By sliding your finger to left and right along the surface of the Ribbon Controller you can simultaneously control two or more specified parameters. From brief touches of accent to smooth changes in tone, this gives you immense possibilities for real-time control.

■ Three types of Key Mode -----

Three key modes are provided: Single, Split, and Dual. With a simple operation you can play different sounds in the left and right areas of the keyboard, or simultaneously play two different sounds from each key. Key Mode settings are stored as part of the Performance.

How to Read This Manual

Quick Start

This section explains how to get started playing the JP-8000, and simple ways to enjoy the various functions. When you need a more detailed explanation, read **Advanced Use**.

Advanced Use

Read this section after you have finished reading **Quick Start**.

Chapter 1. Overview of the JP-8000

This chapter explains the organization of the JP-8000, and the Patches and Performances that are the units of sound data. Be sure to read this chapter in order to understand the JP-8000.

Chapter 2. Patch Editing Procedure

This chapter explains how to select Patches, various procedures for editing a Patch, and how to save a Patch. Please be sure to read this chapter.

Chapter 3. Functions That Modify the Sound

This chapter explains the controllers which modify the sound, such as the various sliders and knobs of the front panel. Read this chapter as necessary.

Chapter 4. Taking Advantage of the Performance Functions

This chapter explains how the ribbon controller, pitch bend lever, and pedals etc. can be used to control the sound. Read this chapter as necessary.

Chapter 5. Playing Arpeggios and Original Patterns (Arpeggiator/RPS)

This chapter explains arpeggiator settings and the settings used for playing back or recording patterns. Read this chapter when you wish to use the arpeggiator or RPS.

Chapter 6. Recording Slider/knob Movements (Motion Control)

This chapter explains how to record and playback slider motions. Read this chapter when you wish to use the Motion Control function.

Chapter 7. Performance/System Settings

This chapter explains the settings in each Performance, and the System settings which affect the entire environment of the JP-8000. Read this chapter as necessary.

Chapter 8. Restoring the Factory Settings (Initialize)

This chapter explains the initialization procedure and the available types of initialization. Read this chapter as necessary.

Chapter 9. Using MIDI

This chapter gives various explanatory examples of how the JP-8000 can be used when connected to external MIDI devices. Read this chapter when you wish to connect the JP-8000 with external MIDI devices.

Appendices

If the unit does not operate the way you expect, refer to "Troubleshooting." If an error message appears during operation, refer to "Error Messages" and take the appropriate action. This section also contains data related to sound editing and MIDI, various lists, and MIDI implementation data, etc.

Front and Rear Panel - Front Panel

* Settings for sections numbered with white-on-black numerals can be stored in a Patch (Patch parameters).

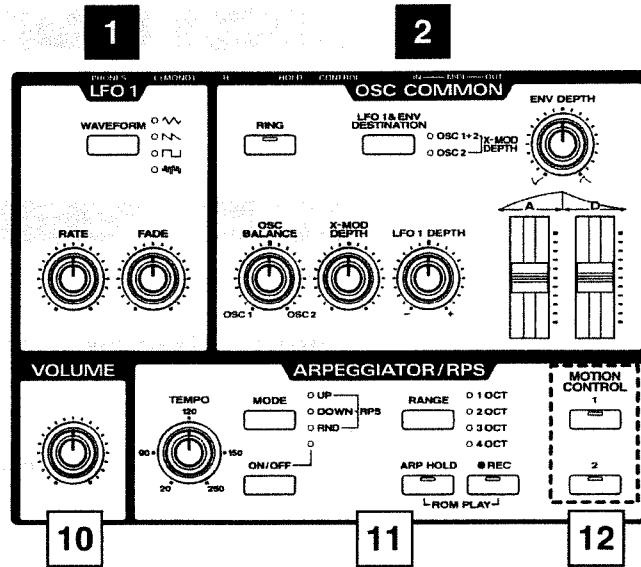
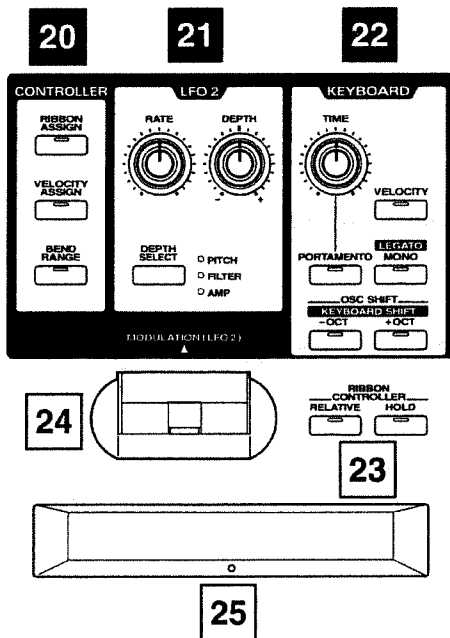

1 LFO1 section

These are the settings for the waveform (LFO 1) which applies cyclic change to the sound (p.63).

2 OSC COMMON (Oscillator Common) section

These are settings related to the OSC 1/OSC 2 section, and settings which determine the pitch (p.58).

3 OSC 1 (Oscillator 1) section

Here you can select the waveform that is the basis of the sound. Your adjustments to the sound are all based on the waveform that is selected here (p.55).

4 OSC 2 (Oscillator 2) section

As in the OSC 1 section, here you can select a waveform that will be the basis of the sound. The sounds of OSC 1 and OSC 2 can be layered in various ways (p.56).

5 FILTER section

Here you can make filter settings to modify the brightness of the sound (p.59).

6 AMP (Amplifier) section

Here you can specify how the volume or sound begins and ends (p.62).

7 TONE CONTROL section

The Tone Control settings adjust the tone of the sound (p.64).

8 CHORUS section

Here you can make Chorus settings to add spaciousness and depth to the sound (p.64).

9 DELAY section

Here you can make Delay settings to create echo effects (p.65).

10 VOLUME knob

This controls the overall volume of the JP-8000. Rotating the knob toward the right will make the volume louder (p.17).

11 ARPEGGIATOR/RPS section

Here you can make arpeggiator/RPS settings (p.75). RPS Patterns and Motions can also be recorded here (p.77, p.83).

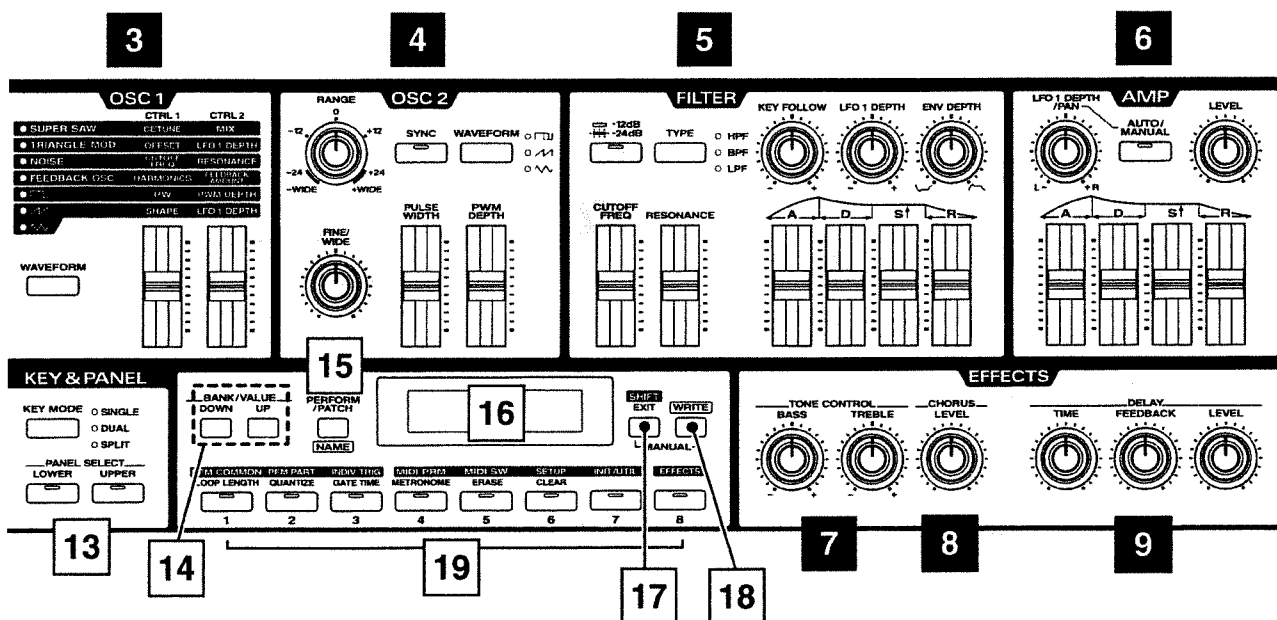

12 MOTION CONTROL section

Press these buttons when you wish to use the Motion Control (1/2) function (p.81).

13 KEY&PANEL section

Here you can change the Key Mode (p.45), and change the Part (Upper/Lower) whose settings will be modified by panel operations.

14 BANK/VALUE buttons

Use these buttons to select the bank of the Patch or Performance, or to modify parameter values.

15 PERFORM/PATCH button

This button switches between the Performance select display and the Patch select display. You can also press this button when you wish to modify the name of a Patch or Performance (p.28, p.54).

16 Display

The selected Patch or Performance, and various parameters and their values are displayed here.

17 SHIFT/EXIT button

Press this button to set Performance parameters or System parameters (p.85), or when you wish to cancel an operation.

18 WRITE button

Press this button to save a Patch or Performance (p.27, p.54), or to copy RPS patterns (p.80).

19 1-8/Parameter buttons

Use these buttons to change the Patch or Performance number, or to select parameters.

20 CONTROLLER section

Here you can specify the parameter that will be controlled by the Ribbon Controller (p.66) or Velocity (p.68), and specify the bend range (p.72).

21 LFO 2 section

Here you can specify how the sound will change when you move the Modulation Lever (p.73).

22 KEYBOARD section

Here you can make settings for various effects related to your keyboard playing: Velocity on/off (p.68), Oscillator Shift (p.71), Keyboard Shift (p.71), Mono/Legato (p.70), and Portamento (p.70).

23 RIBBON CONTROLLER section

Here you can specify how the Ribbon Controller will affect the sound (p.67).

24 Pitch bend lever / Modulation lever

Movements of the lever can produce effects such as modifying the pitch (p.72) or applying vibrato from LFO 2 (p.73).

25 Ribbon controller

By moving your finger to left or right on the surface of this controller, you can simultaneously control multiple parameters (p.66).

Front and Rear Panel – Rear Panel

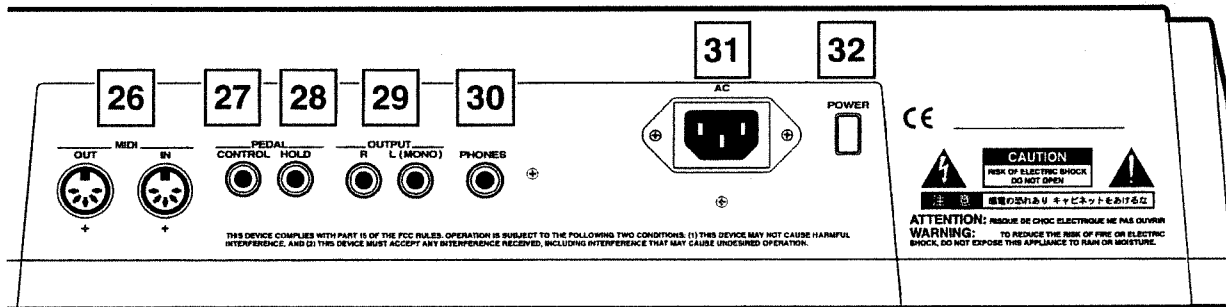

26 MIDI connectors (IN, OUT)

External MIDI devices can be connected here (p.16). Use a MIDI cable (optional) to make connections.

27 CONTROL PEDAL jack

An optional expression pedal (EV-5 etc.) can be connected here. Pedal movements can modify the volume or affect the sound in various ways (p.74).

28 HOLD PEDAL jack

An optional pedal switch (DP-2/6, FS-5U etc.) can be connected here. The pedal can be used to sustain the sound (p.74).

29 OUTPUT jacks (L (MONO), R)

Connect your amp or mixer system to these jacks. If you are using a monaural system, use the L (MONO) jack (p.16).

30 PHONES jack

An optional set of headphones (RH-20/80/120 etc.) can be connected here. Sound will be output from the OUTPUT jacks even if headphones are connected (p.16).

31 AC inlet

Connect the included Power cord to this inlet (p.16).

32 Power switch

This switch turns the power on/off (p.17).

Printing Conventions in This Manual

In order to present information as clearly as possible, the following conventions are used in this manual.

- Text or numerals enclosed in square brackets [] indicate buttons, sliders, or knobs on the panel. For example [WAVEFORM] indicates the Waveform button, and [RATE] indicates the Rate knob.
- Indications such as [DOWN]/[UP] mean that you may press either button.
- References such as (p.***) indicate pages in this manual to which you can refer.
- The dark/lit/blinking status of an indicator is distinguished as follows.



JP-8000

Quick Start

Step 1 Playing the Sounds

Connections

The JP-8000 does not contain an amplifier or speakers. In order to hear the sound, you will need to connect a keyboard amp, audio system, or headphones. Refer to the following diagram and connect the JP-8000 to your system.

- * Audio cables, MIDI cables, stereo headphones, expression pedal, and pedal switch are not included. You may purchase these items separately at your dealer.

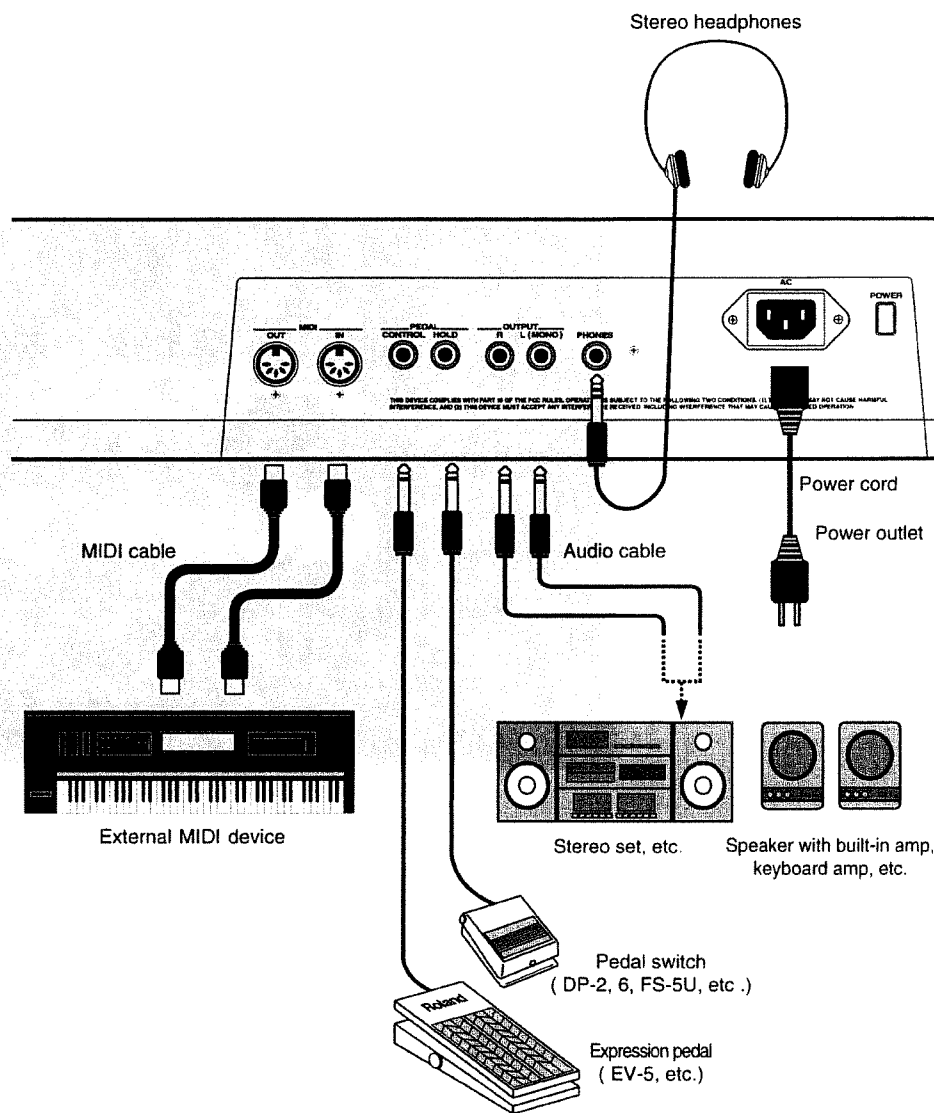

1. Before you begin making connections, check the following points.
 - Are the volume controls of the JP-8000 and of your mixer/amp system turned to the minimum position?
 - Is the power of the JP-8000 and of your mixer/amp system turned off?
- * Before connecting the JP-8000 to external devices, be sure to turn the volume control of all devices to the minimum position and turn their power off.

Restoring the Factory Settings (Initialize)

If you have modified the settings on your JP-8000 after you purchased it, you may find it difficult to follow the explanations in this Quick Start section. If this is the case, you can use the following procedure to restore the factory settings before you read through the Quick Start section.

- * When you perform the Initialize operation, the data in memory will be returned to the factory settings. If memory contains data that you wish to keep, use the Bulk Dump operation (p.97) to save your data to an external MIDI device before you Initialize.

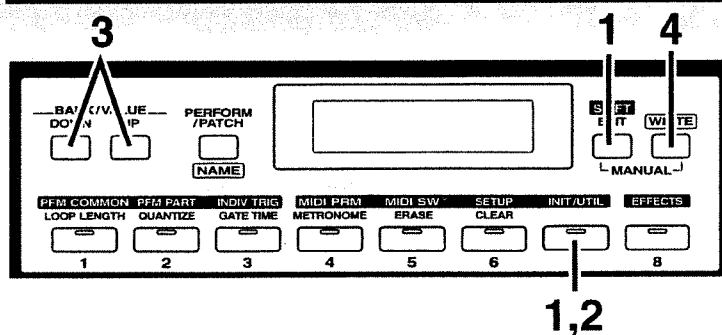

1. While holding down [SHIFT] ([EXIT]), press [INIT/UTIL] ([7]).

The [INIT/UTIL] indicator will light.

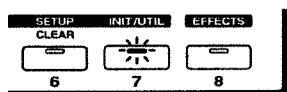

2. Press [INIT/UTIL] several times to access the Initialize display.

```
Initialize[WRITE]
PATCH:      TEMP
```

3. Use [DOWN/UP] several times to choose [FACTORY PRESET].

```
Initialize[WRITE]
FACTORY PRESET ←
```

To cancel without initializing, press [EXIT].

4. Press [WRITE].

The display will indicate "Completed," and then the previous display will reappear.

```
Completed
```

The factory settings have now been restored.

- ◆ It is also possible to select just a specified type of data (such as only Patches, or only RPS patterns, etc.) for restoration to the factory settings.

→ "Chapter 8. Restoring the Factory Settings (Initialize)" (p.91)

Listening to the Demo Songs

The JP-8000 contains demo songs that show off the musical potential of the instrument. Here's how to listen to these demo songs.

- * When you playback the demo songs, the Temporary Performance and Patch settings (p.50) will be lost. If you wish to keep these settings, save the Performance or Patch settings (p.27, p.54) before you listen to the demo playback.

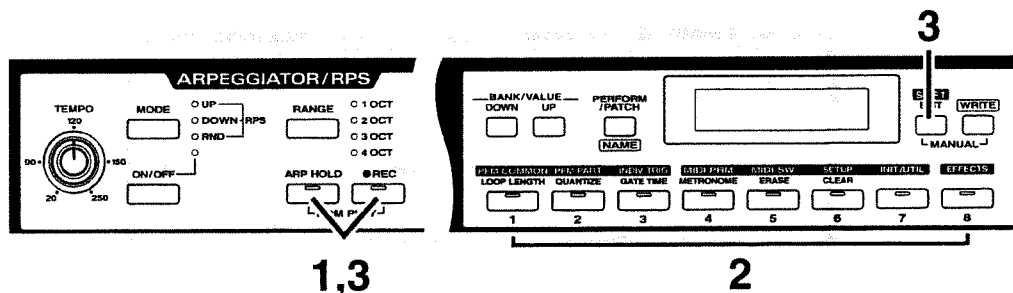

- 1.** Simultaneously press [ARP HOLD] and [REC].
The display will indicate "ROM PLAY", and the demo songs will playback consecutively.
- 2.** If you wish to listen to from in the middle of the song, press a key [1]–[8].
- 3.** To return to the condition in which you can play the keyboard of the JP-8000, once again simultaneously press [ARP HOLD] and [REC], or press [EXIT].

The previous display will reappear.

- * While the demo songs are playing back, playing the keyboard will not produce sound. Also, the musical data of the demo song playback will not be transmitted from the MIDI OUT connector.
- * All rights reserved. Unauthorized use of this material for purposes other than private, personal enjoyment is a violation of applicable laws.

.....

◆ [1] – [7]

Music by Mitsuru Sakaue Copyright © 1996, Roland Corporation

Mitsuru Sakaue

From his college days, Mitsuru Sakaue has been active as a keyboard player and arranger in studio and commercial music production. At present he is involved in production of commercials for TV and radio as a composer, arranger, keyboard player and computer music expert. His highly acclaimed musical abilities go beyond borders of musical genre. He is the chief director of the Idexs (Inc.) group of creative musical artists.

◆ [8]

Copyright © 1996, Roland Corporation

.....

Playing the Sounds

The JP-8000 contains a wide variety of sounds. In this section we will select *Performances* to hear the various sounds.

Performances can be selected by specifying a *Bank* (which contains eight Performances) and the *Number* of the desired Performance within the specified Bank.

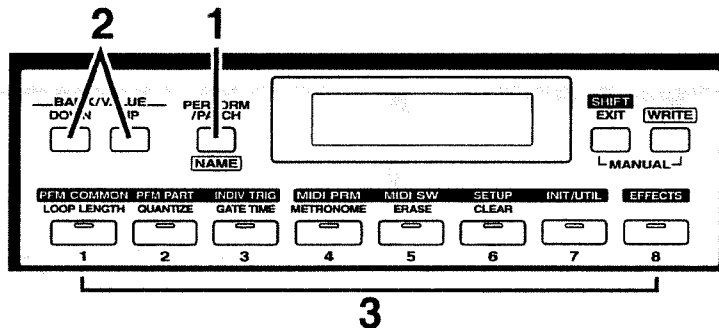

1. Make sure that the upper left of the display indicates "PERFORM."

If not, press [PERFORM/PATCH] to get the correct display.

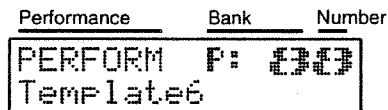

2. Use [DOWN/UP] to select a Bank (U:1-U:8, P:1-P8).

If you hold down one of the [DOWN]/[UP] buttons and then press the other button, the change will become more rapid in the direction of the first-pressed button. You can use this function whenever using the [DOWN]/[UP] buttons to specify a value.

3. Press [1]-[8] to select a Number (1-8).

The indicator of the button you pressed will light.

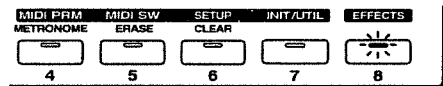

4. Play the keyboard to hear the sound.

The selected Performance will sound.

Select different Performances and play them.

-
- ◆ For more details on Performances,
 - "Patches and Performances" (p.48)
 - ◆ For details on Performance numbers and the contents of each,
 - "Performance List" (separate sheet)
-

Step 2. Modifying the Sound

In step 2 we will use the panel sliders and knobs etc. to modify the sound in real-time.

Each Performance is assigned settings for two sounds, which are called "Patches." By using the slides or knobs etc. to modify the settings of these Patches you can modify the sound in various ways.

The two Patches are assigned to the *Lower Part* and the *Upper Part* respectively. From the panel you can modify the settings of the Patch which is assigned to the Part whose [LOWER] or [UPPER] indicator is lit.

Using "Waveform" to Modify the Waveform

Now let's select and listen to a Waveform — the most basic element of a Patch. By using the sliders and knobs to modify the waveform you can create a variety of sounds.

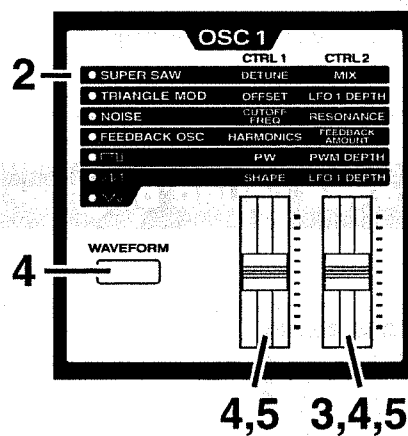

1. Select the Performance P:88 (p.20).

By playing the keyboard, you will hear the sound of the patch which is assigned to the Upper Part. Let's modify this sound.

2. In the OSC 1 section, make sure that "SUPER SAW" is selected.

	CTRL 1	CTRL 2
SUPER SAW	DETUNE	MIX
● TRIANGLE MOD	OFFSET	LFO 1 DEPTH
● NOISE	CUTOFF FREQ	RESONANCE

Play the keyboard and listen to SUPER SAW.

3. As you raise [CTRL 2] (MIX), the sound will become thicker as if several sounds were being played simultaneously.

4. Press [WAVEFORM] twice to select "NOISE."

● TRIANGLE MOD	OFFSET	LFO 1 DEPTH
NOISE	CUTOFF FREQ	RESONANCE
● FEEDBACK OSC	HARMONICS	FEEDBACK AMOUNT
● [F] [L]	PW	PWM DEPTH

Leave [CTRL 2] (RESONANCE) at the position shown in the illustration, and move [CTRL 1] (CUTOFF FREQ) to change the sound in various ways.

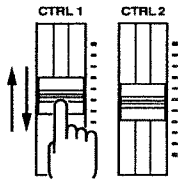

5. Using the same procedure, listen to the sound of other waveforms.

Move [CTRL 1]/[CTRL 2] to change the sound in various ways.

- ◆ For details on the settings of the OSC 1 section
→ "Selecting the Basic Waveform for the Sound (1) (Oscillator 1)" (p.55)
- ◆ For details on other OSC -related settings
→ "Selecting the Basic Waveform for the Sound (2) (Oscillator 2)" (p.57)
→ "Modifying the Waveform and Pitch of the Sound (Oscillator Common)" (p.58)

Using "Cutoff Frequency" to make the sound brighter/darker

Let's try modifying the brightness of the sound.

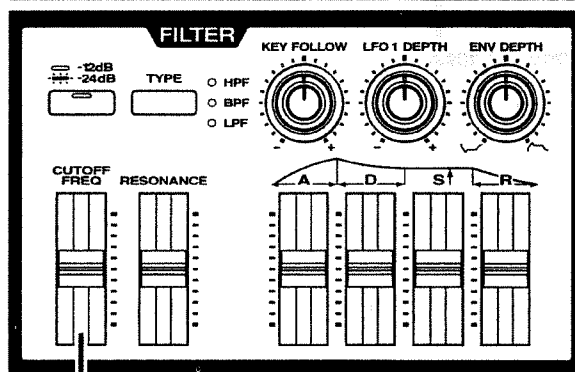

2

1. Select Performance P:88 (p.20).

By playing the keyboard, you will hear the Upper Patch sound. Let's modify this sound.

2. While playing the keyboard, move the FILTER section [CUTOFF FREQ] slider.

Raising the slider will make the sound sharper and brighter.

Lowering the slider will make the sound mellower and darker.

- ◆ For details on [CUTOFF FREQ]
→ "Modifying the Brightness (Filter)" (p.59)

Using "Resonance" to Add Character to the Sound

Now let's give the sound more character.

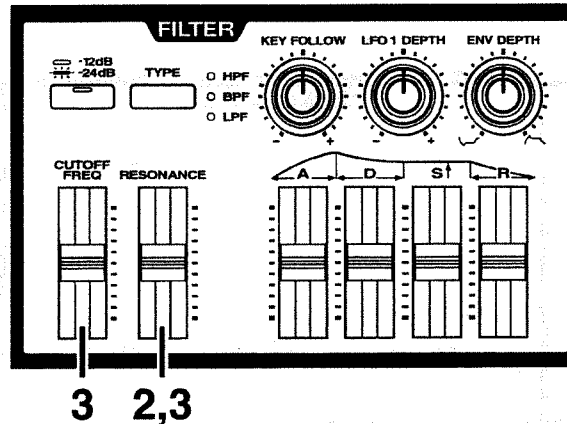

1. Select the Performance P:88 (p.20).
By playing the keyboard, you will hear the Upper Patch sound. Let's modify this sound.
2. As you play the keyboard, move the FILTER section [RESONANCE] slider.
Raising the slider will give the sound a more distinct character.
Lowering the slider will make the sound more natural.
* With excessively high settings of [RESONANCE], you may hear an additional sound that is different than the sound of the Patch, so excessively high settings should normally be avoided. (This phenomenon is called "oscillation.")
3. Leave [RESONANCE] at the position shown in the illustration, and now try moving [CUTOFF FREQ].

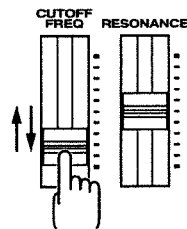

You will hear a "miew miew" or "auwh auwh" sound typical of synthesizers. A combination of changes in [CUTOFF FREQ] and [RESONANCE] is one of the most frequently used sound modifications on synthesizers.

-
- ◆ For details on [RESONANCE],
→ "Modifying the Brightness (Filter)" (p.59)
-

Using "LFO 1" to Add Modulation to the Sound

The LFO 1 waveform is independent of OSC 1 (even if the waveforms themselves are the same), and is used to modulate the sound (i.e., to apply cyclic change). Let's change the sound by using the LFO 1 to modulate the pitch.

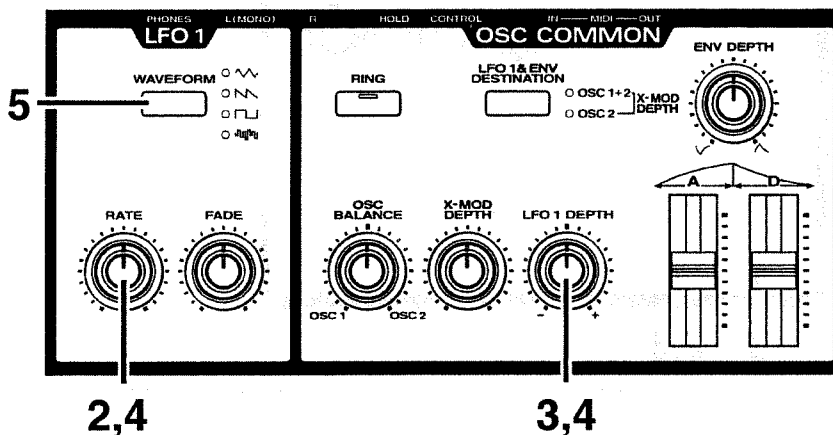

1. Select the Performance P:88 (p.20).

By playing the keyboard, you will hear the Upper Patch sound. Let's modify this sound.

2. Rotate the LFO 1 section [RATE] knob to the position shown in the illustration.

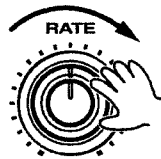

3. Rotate the OSC COMMON section [LFO 1 DEPTH] knob to the position shown in the illustration.

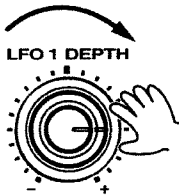

4. Play the keyboard, and notice how the sound is modulated.

The sound cyclically becomes higher or lower.

Rotating [LFO 1 DEPTH] will increase/decrease the amount of modulation.

Rotating [RATE] will modify the speed of modulation.

5. By pressing the LFO 1 section [WAVEFORM] button, you can change the way in which the sound is modulated.

Try out the different waveforms.

- ◆ Rotate the FILTER section [LFO1 DEPTH] toward the right, and the brightness will change cyclically.
 - "Modifying the brightness (Filter)" (p.59)
- ◆ Rotate the AMP section [LFO1 DEPTH] toward the right, and the volume will change cyclically.
 - "Modifying the volume (Amplifier)" (p.62)
- ◆ For details on the settings of the LFO1 section
 - "Modulating the Sound (LFO1)" (p.63)
- ◆ You can also add modulation at the desired timing while you play.
 - Adding Cyclic Change (Modulation Lever (LFO2))" (p.73)

Using "Tone Control" to adjust the tone

The Tone Control knobs are used to adjust the low/high frequency ranges of the sound, so that the tonal quality is to your taste. Let's use the Tone Control knobs to emphasize the low range.

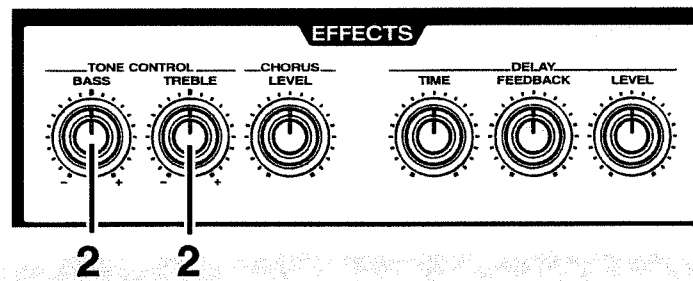

1. Select Performance P:88 (p.20).
By playing the keyboard, you will hear the Upper Patch sound. Let's modify this sound.
2. While playing the keyboard, rotate the TONE CONTROL section [BASS] knob to the position shown in the diagram.

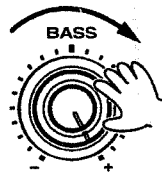

The low range will be emphasized more than when the [BASS] setting was low, producing a solid sound. If you also rotate [TREBLE] toward the right in the same way to emphasize the high range, the sound will have both a solid bottom and a crisp top.

- ◆ For details on the settings of the TONE CONTROL section
 - "Modifying the tone (Tone Control) (p.64)

Using "Chorus" to Broaden the Sound

By using Chorus, even single notes can be given a broad and spacious sound that is characteristic of multiple sounds occurring at once.

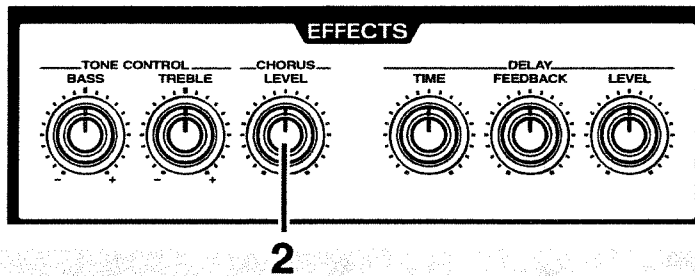

- 1. Select the Performance P:88 (p.20).**
By playing the keyboard, you will hear the Upper Patch sound. Let's modify this sound.
- 2. While playing the keyboard, rotate the CHORUS section [LEVEL] knob.**
This will adjust the depth of the chorus effect.

.....
◆ For details on the settings of the CHORUS section
 > "Adding Spaciousness and Depth to the Sound (Chorus)" (p.64)
.....

Using "Delay" to Add Echo to the Sound

Let's use Delay to add an echo-like effect to the sound.

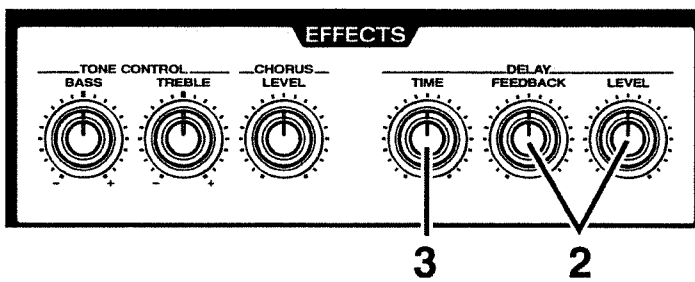

- 1. Select the Performance P:88 (p.20).**
By playing the keyboard, you will hear the Upper Patch sound. Let's modify this sound.
- 2. Rotate the DELAY section [FEEDBACK] and [LEVEL] knobs to the positions shown in the illustration.**

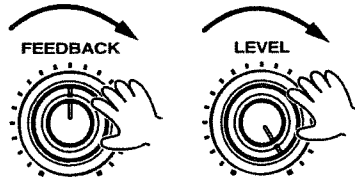

3. Play the keyboard and listen to the sound.

An echo effect will be applied. (This effect is called "Delay.") Rotating the [TIME] knob will modify the intervals at which the delay sound is heard.

-
- ◆ For details on the settings of the DELAY section
→ "Adding an Echo Effect (Delay)" (p.65)
-

Storing a Performance

Now that you have worked through the examples in Step 2 and created a sound that's to your liking, let's write the Performance into memory.

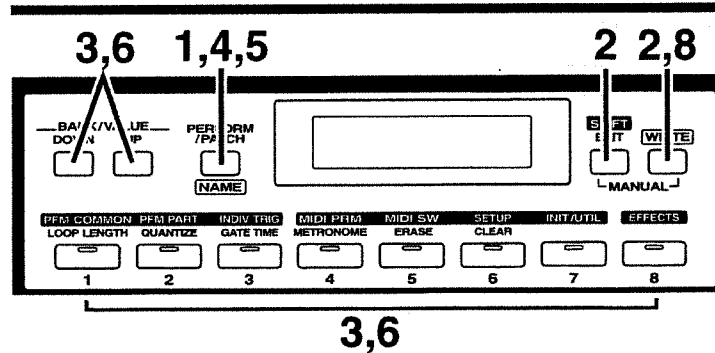

Once you modify the sound with a slider/knob and button, then "*" (asterisk) will appear at the left of the Performance number, indicating that the settings of the selected Performance have been modified.

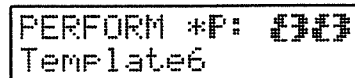

If you select a different Performance while the asterisk is displayed, the current settings will be lost. If you wish to keep the current settings, you must use the following procedure to write them to a User Performance (a Performance whose number begins with a "U"). You can assign a name of up to 16 characters to your Performance.

- * The new modified Performance will be written over the User Performance that previously existed in that memory.

1. Press [PERFORM/PATCH] to appear in "PERFORM" the upper left of the display.

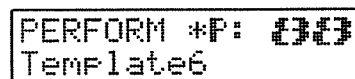

2. Press [WRITE].

The following display will appear, and the " _ " (cursor) will appear below the Performance number.

```
Write PERFORM ##
Template6
```

To cancel the Performance write procedure, press [EXIT].

* If you do not wish to modify the Performance number and the Performance name, skip steps 3-7.

3. Use [DOWN]/[UP] and [1]-[8] to select the writing destination for the Performance.

4. Press [NAME] ([PERFORM/PATCH]).

Now you can input the Performance name.

The cursor will move to the beginning of the second line of the display.

```
Write PERFORM ##
Template6
```

* When the cursor is on the first line, the name of the saving destination Performance will be displayed. When the cursor is on the second line, the name of the newly modified Performance will be displayed.

5. Press [NAME] and move the cursor to the location where you wish to input a character.

6. Use [DOWN]/[UP] to specify the character.

```
Write PERFORM ##
Template6
```

The following characters can be selected.

space, A-Z, a-z, 0-9, ! " # \$ % & ' () * + , - . / : ; < = > ? @ [\] ^ _ ` { | }
.....

When inputting characters, the [1]-[8] buttons have the following convenient functions.

- [1] : Move the cursor backward. If the cursor is already at the left edge, it will move to the Patch number location.
 - [2] : Display a space at the cursor location.
 - [3] : Display an "A" at the cursor location.
 - [4] : Display an "a" at the cursor location.
 - [5] : Display a "0" at the cursor location.
 - [6] : Switch between uppercase and lowercase characters.
 - [7] : Insert a space at the cursor location.
 - [8] : Delete the character at the cursor location, and shift subsequent characters to the left.
-

7. Repeat steps 5-6 to input the Performance name.

8. Press [WRITE].

The display will indicate "Completed" and the previous display will reappear.

```
Completed → PERFORM U: ##
NEW PERFORM NAME
```

The Performance has now been stored into memory.

- * The Patches stored within a Performance are displayed as "UPPER" and "LOWER." Be aware that the original Patch numbers are not displayed.
- * The Patch names of the Patches stored within a Performance cannot be modified directly. If you wish to store new Patch names into a Performance, refer to "To Modify the Patch Name of a Patch stored in a Performance" (p.54).

.....

- ◆ In addition to the operations explained in Step 2, each one of the front panel sliders and knobs etc. can be used to modify the sound.
 - "Chapter 3. Functions that Modify the Sound" (p.55)
- ◆ If you wish to restore the Performance that you overwrote to the factory settings
 - "Restoring only a specific User Patch or User Performance to the factory settings" (p.91)
- ◆ In addition to the sound settings, a variety of other settings such as the Key Mode and Arpeggiator settings etc. can also be stored in a Performance.
 - "Patches and Performances" (p.48)
- ◆ Patch settings can be stored by themselves separately from Performances.
 - "Storing a Patch" (p.54)

.....

Step 3. Shortcut! Convenient Functions of the JP-8000

Adjusting Many Sliders at Once (Ribbon Controller)

This section explains how multiple sliders/knobs can be adjusted simultaneously. This is done using the Ribbon Controller. By using the ribbon controller, a single movement of your finger can produce the same result as when multiple sliders/knobs are moved simultaneously.

Let's make settings so that the sound will change as if [CUTOFF FREQ] and [RESONANCE] were moved simultaneously.

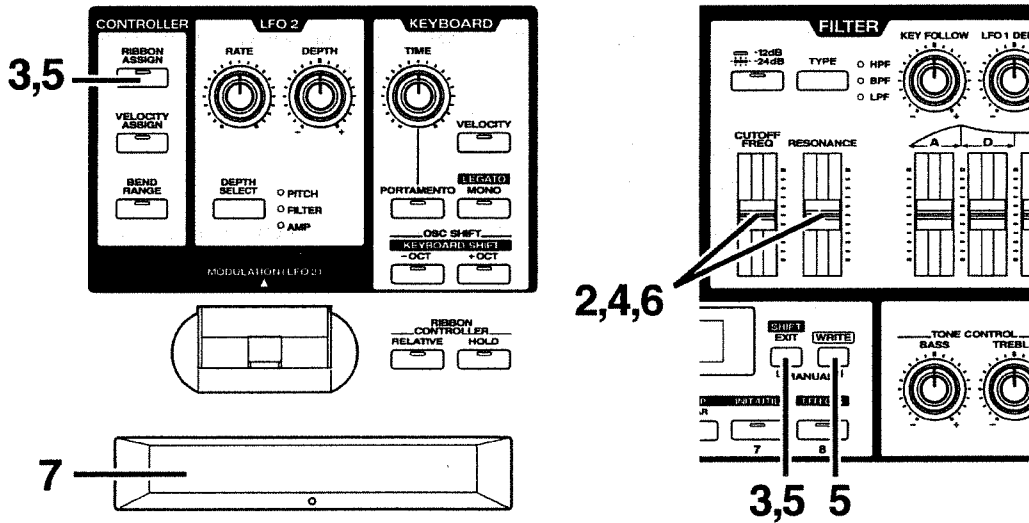

1. Select the Performance P:88 (p.20).

By playing the keyboard, you will hear the Upper Patch sound. Let's modify this sound by Ribbon Controller.

2. Move [CUTOFF FREQ] and [RESONANCE] to the positions shown in the illustration.

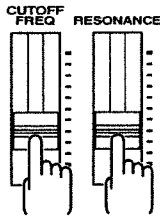

3. Press [RIBBON ASSIGN].

The indicator will begin blinking, and the following display will appear.

```
Ribbon Assign
(Not Assigned)
```

To cancel the procedure, press [RIBBON ASSIGN] or [EXIT].

4. Move [CUTOFF FREQ] and [RESONANCE] to the positions shown in the illustration.

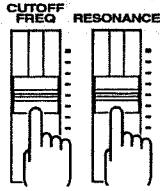

5. Press [RIBBON ASSIGN] or [EXIT].

The [RIBBON ASSIGN] indicator will change to lit, and the previous display will reappear.

Ribbon controller settings have now been made.

.....

● **If you make a mistake**

If you make a mistake while making ribbon controller settings, press [RIBBON ASSIGN], and when the following display appears press [WRITE].

```
Ribbon Assign
All Clear[WRITE]
```

The display will indicate "Completed" and the ribbon controller settings will be canceled.

Then re-do the procedure from step 2.

.....

6. Return [CUTOFF FREQ] and [RESONANCE] to the positions of step 2.

7. While playing the keyboard, press the center of the ribbon controller, and slide your finger toward the right edge.

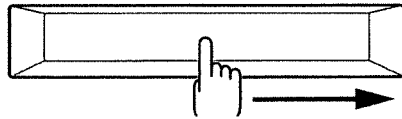

The same change in the sound will occur as when [CUTOFF FREQ] and [RESONANCE] are moved simultaneously.

Sliding your finger toward the left will produce the same change in the sound as when [CUTOFF FREQ] and [RESONANCE] are moved in the opposite direction.

.....

◆ **For details on the ribbon controller**

→ "Controlling Multiple Parameters Simultaneously (Ribbon Controller)" (p.66)

◆ **Your keyboard playing dynamics can produce the same effect as the ribbon controller.**

→ "Using Keyboard Dynamics to Affect Parameters (Velocity)" (p.68)

◆ **Ribbon controller settings can be saved in a Patch.**

→ "Storing a Performance" (p.27)

→ "Storing a Patch" (p.54)

.....

Producing Arpeggios when Chords are Played (Arpeggiator)

The JP-8000 allows you to automatically play an arpeggio (broken chord) simply by holding down two or more notes.

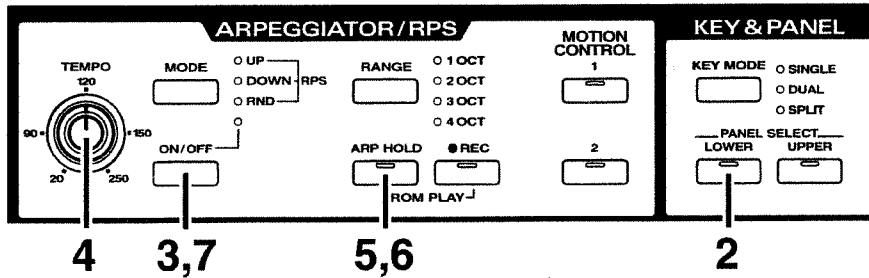

Here's how to produce the following arpeggio.



1. Select the Performance P:88 (p.20).
2. Press [LOWER].

By playing the keyboard, you will hear the Lower Patch sound. Let's play the arpeggio using this sound.

3. Press [ON/OFF].

The indicator will light, and the arpeggiator will be turned on.

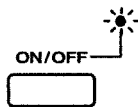

4. Hold down the following notes on the keyboard.

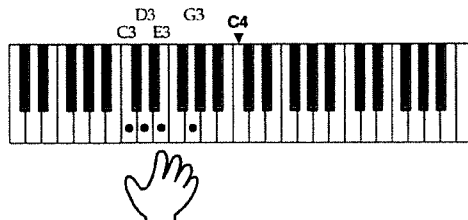

The arpeggio will begin to play.

The arpeggio will play as long as you continue holding the notes.

Rotate [TEMPO] to adjust the tempo to your liking.

5. If you press [ARP HOLD], the indicator will light and the arpeggio will continue to play even if you take your hand off the keyboard.

6. To stop the arpeggio, press [ARP HOLD] once again.

The indicator will go dark.

7. To turn off the arpeggiator, press [ON/OFF].

The indicator will go dark.

.....
◆ For details on arpeggio settings

→ "Playing Arpeggios (Arpeggiator)" (p.75)

◆ Arpeggiator settings can be saved in a Performance.

→ "Storing a Performance" (p.27)
.....

Playing Patterns with One Finger (RPS)

Normally, pressing a key on the keyboard will play only the note that was pressed. However RPS (Real-time Phrase Sequence) is a function that plays back a variety of musical patterns when a key is pressed, instead of the note for that key. If there are musical passages that you need to play repeatedly, you can assign each pattern to a key, and then play the desired pattern simply by pressing one key.

First let's listen to the patterns which are assigned to each key.

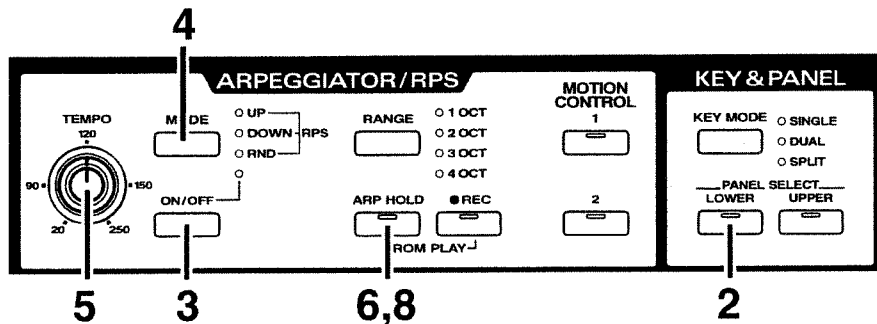

1. Select the Performance P:88 (p.20).

2. Press [LOWER].

By playing the keyboard, you will hear the Lower Patch sound. Let's play the patterns using this sound.

3. Press the [ON/OFF] switch to turn on the arpeggiator.

The indicator will lit.

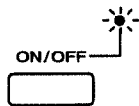

4. Press [MODE] several times to make all three indicators light, to select RPS.

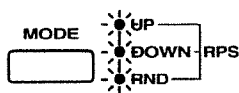

5. Press various keys and listen to the pattern that plays back for each key.

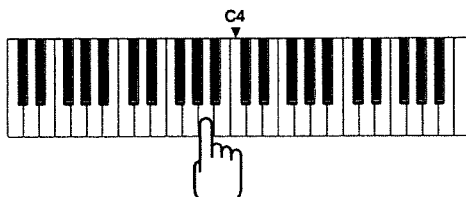

The pattern will continue repeating as long as you hold down the key.

Rotate [TEMPO] to adjust the tempo to your liking.

6. If you press [ARP HOLD], the indicator will light and the pattern will continue playing even if you take your hand off the keyboard.

3. Press [CLEAR] ([6]).

The indicator will blink, and the following display will appear.

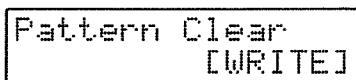

To cancel the pattern clear operation, press [CLEAR] or [EXIT].

4. Press [WRITE].

The display will indicate "Completed," and the sound will stop.



The pattern that had been assigned to the right-most key has been cleared.

5. Press [EXIT].

The [REC] indicator will go dark.

- ◆ To restore the cleared pattern to the factory settings
 - "Chapter 8. Restoring the Factory Settings (Initialize)" (p.91)

■ **Creating a Pattern**

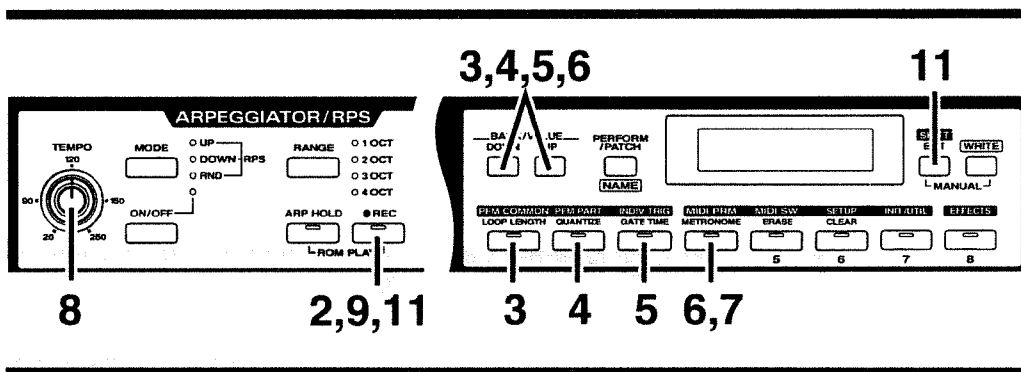

Let's create a pattern like the following.



- 1.** Follow steps 1-4 on page 34 to prepare for pattern playback.
- 2.** Hold down [REC] and press the right-most key.

The indicator will blink, and the following display will appear.



```
Pattern(C 6) REC
[STBY] M= 1 B= 4
```

3. Press [LOOP LENGTH] ([1]).

The indicator will light, and the pattern length will appear in the display.

Since in this example we will be creating a one-measure pattern, use [DOWN]/[UP] several times to select "1".

```
Loop Length
1
```

4. Press [QUANTIZE] ([2]).

The indicator will light, and the display will indicate the shortest note value that will be recorded.

Use [DOWN]/[UP] several times to select "♩".

```
Input Quantize
♩
```

.....

The operation in step 4 sets the Quantize function. Quantize is a function that "tightens up" the timing of the notes you play, aligning them to precise intervals of the specified note value. Normally you should set this to the shortest note value that you wish to record.

.....

5. Press [GATE TIME] ([3]).

The indicator will light, and the display will indicate the note duration that will be recorded.

Since in this example we will be inputting staccato notes, use [DOWN]/[UP] several times to select "STACCATO."

```
Gate Time Ratio
STACCATO
```

6. Press [METRONOME] ([4]).

The indicator will light, and the display will indicate the type of metronome sound and the volume.

Use [DOWN]/[UP] several times to select "Type1: VOLUME 2".

```
Metronome
Type1: VOLUME 2
```

7. Press [METRONOME] or [EXIT].

The [METRONOME] indicator will go dark, and the previous display will reappear.

8. Rotate [TEMPO] to select a tempo that you find convenient for recording.

While the [REC] indicator is blinking, recording will not take place even if you play the keyboard. You can practice the phrase while listening to the metronome sound to keep in tempo.

This completes preparations for recording.

Now let's record the pattern.

9. Press [REC].

The indicator will change to lit, and recording will begin.

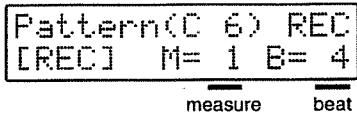

10. Play the musical example given at the beginning of this section, and record it.

11. Press [REC] or [EXIT].

The [REC] indicator will go dark, and recording will end.

12. Press the right-most key, and listen to the pattern playback.

- ◆ For details on settings for recording
 - "Settings for Recording" (p.77)
- ◆ For details on recording
 - "Recording a Pattern" (p.78)
- ◆ You can copy a pattern to a different key.
 - "Copying a Pattern" (p.80)

■ If You Make a Mistake While Recording

If you make a mistake while recording, use the following procedure to erase the wrong note.

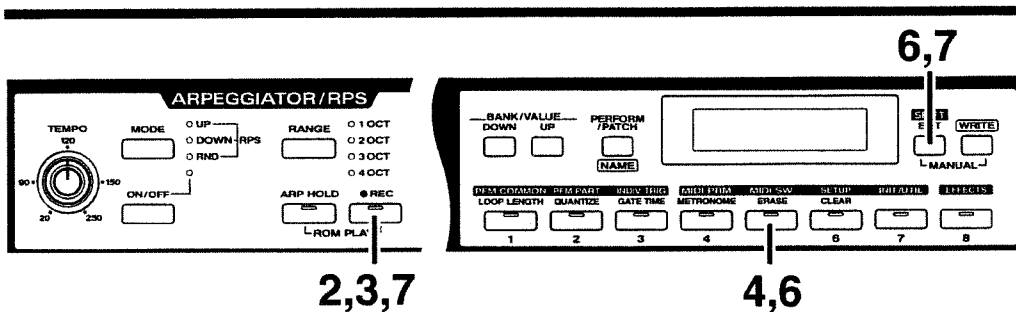

1. Follow steps 1–4 on page 34 to prepare for pattern playback.

2. Hold down [REC] and press the right-most key.

The indicator will begin blinking.



3. Press [REC] once again.
The indicator will change to lit, and recording will begin.

4. Press [ERASE] ([5]).
The indicator will light, and the following display will appear.

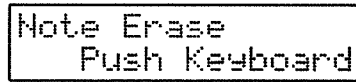

5. At the timing that the wrong note sounds, press the key for that note. While you continue holding that key, all notes on that key will be erased.

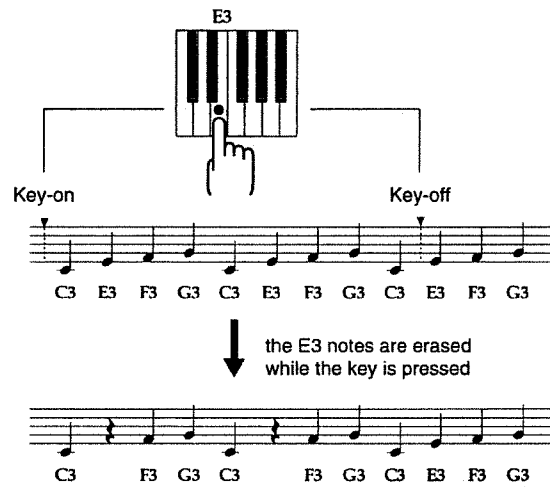

6. When all the wrong notes have been erased, press [ERASE] or [EXIT].
The indicator will go dark, and the previous display will reappear. You will be in normal recording mode, and can now record new notes.

7. To end recording, press [REC] or [EXIT].
The [REC] indicator will go dark, and recording will end.

-
- ◆ A range of notes between specified keys can be erased from a pattern.
→ "Erasing Unwanted Notes " (p.79)
-

Easily Controlling Complex Tonal Changes (Motion Control)

Normally, it is all you can do to move one or two sliders/knobs as you play, but there may be times at which you would like to operate more sliders/knobs to produce more complex tonal changes. In such cases you can use Motion Control. Motion Control is a function that can store movements (motions) of two or more sliders/knobs.

While playing back the pattern that you created in the previous section, let's playback a Motion to modify the sound.

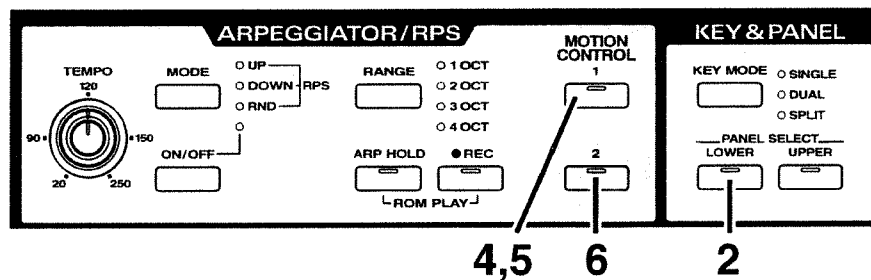

1. Select the Performance P:88 (p.20).
2. Press [LOWER].
By playing the keyboard, you will hear the Lower Patch sound. Let's modify this sound by Motion Control.
3. Follow steps 1-4 on page 34 to prepare for pattern playback, and playback the pattern of the C6 key (p.34).

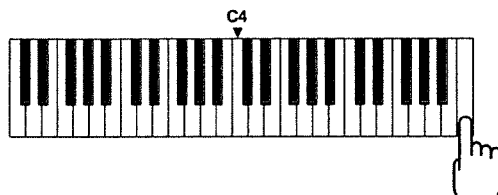

4. Press MOTION CONTROL [1].
The indicator will blink, and the Motion of [1] will playback.
The tone will change as though various sliders/knobs are being moved simultaneously.
5. To stop the Motion, press [1] once again.
The indicator will go dark.
6. In the same way, listen to the Motion of [2].

- ◆ For details on playing back a Motion
→ "Playing Back a Motion" (p.81)
- ◆ To change the tone in additional ways while playing back a Motion
→ "Moving Sliders or Knobs While Playing Back Motions" (p.81)
- ◆ To playback a Motion simultaneously when a Pattern is selected
→ "Playing Back the Motion From the Beginning Each Time a Key is Pressed (Motion Restart)" (p.82)

■ Preparing to Record a Motion (Clearing a Motion) ●●●●●●●●●●

In the same way as before recording a pattern, you must first prepare a place for the newly recorded Motion. Use the following procedure to clear (erase) Motion [2].

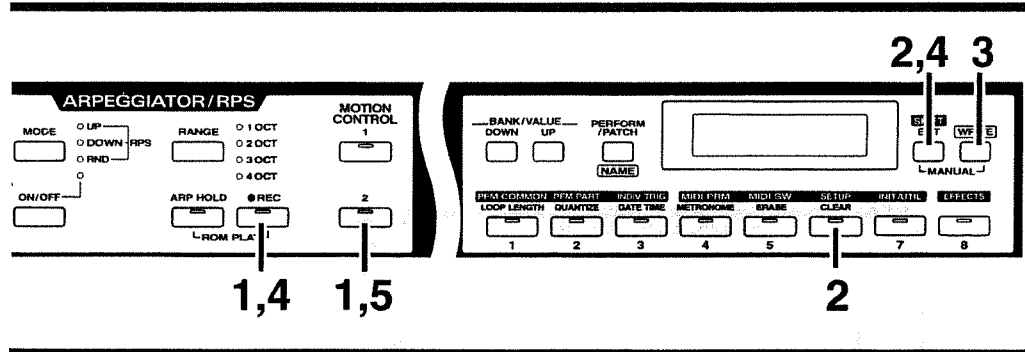

1. Hold down [REC] and press MOTION CONTROL [2].
The [REC] and [2] indicators will blink, and the following display will appear.

```
Motion(A-2) REC
[STBY] M= 1 B= 4
```

2. Press [CLEAR] ([6]).
The indicator will light, and the following display will appear.

```
Motion Clear
[WRITE]
```

To cancel the Motion Clear operation, press [CLEAR] or [EXIT].

3. Press [WRITE].
The display will indicate "Completed," and then the previous display will reappear.

```
Completed → Motion(A-2) REC
[STBY] M= 1 B= 4
```

Motion [2] has now been erased.

4. Press [EXIT].
The [REC] indicator will go dark.
5. Press MOTION CONTROL [2].
The indicator will go dark.

◆ To restore a Motion that you erased
→ "Chapter 8. Restoring the Factory Settings (Initialize)" (p.91)

■ Recording a Motion

Now let's create a Motion for the pattern that we recorded in the previous section for the C6 key.

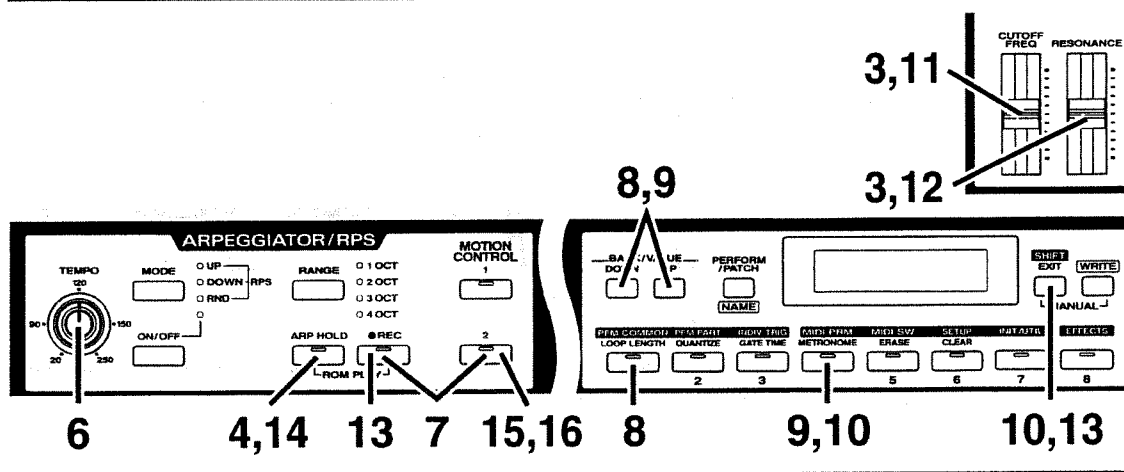

1. Select the Performance P:88.
2. Press [LOWER].
The indicator will light, and the Lower Patch will be selected.
3. Move the [CUTOFF FREQ] and [RESONANCE] to the center position.
4. Press [ARP HOLD].
The indicator will light.
5. Follow steps 1-4 on page 34 to prepare for pattern playback, and playback the pattern of the C6 key.
Since Hold is On, the pattern playback will continue to repeat even if you release the key.
6. While listening to the pattern, rotate [TEMPO] to set a tempo that will be convenient for recording.
7. Hold down [REC] and press MOTION CONTROL [2] in time with the beginning of the pattern.
The [REC] and [2] indicators will blink, and the following display will appear.

```
Motion(A-2) REC
[STBY] M= 1 B= 4
```

8. Press [LOOP LENGTH] ([1]).
The indicator will light, and the display will show the length of the Motion.
Since in this example we will be creating a Motion that is four measures long, use [DOWN]/[UP] several times to select "4".

```
Loop Length 4
```

9. Press [METRONOME] ([4]).

The indicator will light, and the type and volume of the metronome sound will be displayed.
Use [DOWN]/[UP] several times to select "Type1: VOLUME 2".

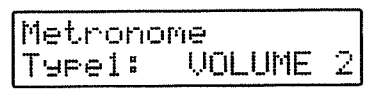

10. Press [METRONOME] or [EXIT].

The indicator will go dark, and the previous display will reappear.
This completes preparations for recording.
Now let's record a Motion.

11. Starting when the count is "M=1 B=1", move [CUTOFF FREQ] as follows.

The [REC] indicator will change to lit, and recording will begin.

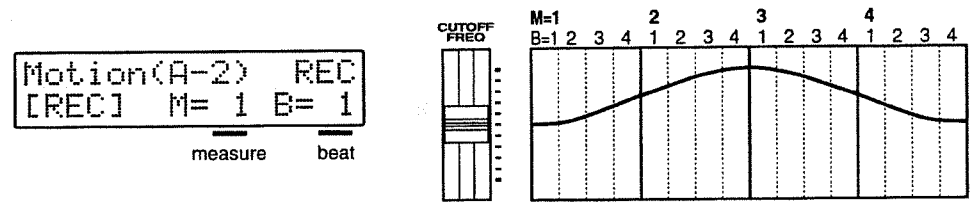

At the end of the fourth measure, recording will automatically end, and the [REC] indicator will change to blinking.

12. Starting when the count is "M=1 B=1", move [RESONANCE] as follows.

The [REC] indicator will change to lit, and recording will begin.

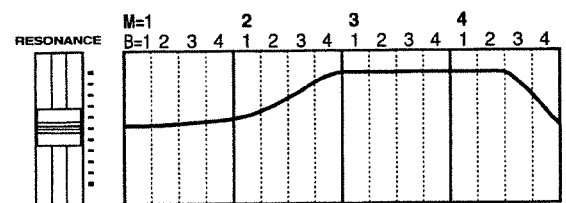

At the end of the fourth measure, recording will automatically end, and the [REC] indicator will change to blinking.

13. Press [REC] or [EXIT].

The [REC] indicator will go dark, and recording will end.

14. Press [ARP HOLD] to stop pattern playback.

15. Press MOTION CONTROL [2] to stop Motion playback.

16. While playing back the pattern of the C6 key, press MOTION CONTROL [2] to hear the change in tone created by the Motion that you recorded.

-
- ◆ For details on recording settings
→ "Settings for Recording" (p.83)
 - ◆ For details on recording
→ "Recording a Motion" (p.83)
-

■ If You Make a Mistake While Recording •••••

If you make a mistake while recording a Motion, use the following procedure to correct it.

If you don't like the Motion that you recorded

When a Motion is recorded, movements of the same slider/knob are overwritten. This means that if you wish to re-do a Motion, simply re-record the movement of that slider/knob. The old movement will be overwritten by the newly recorded movement.

If you moved the wrong slider or knob by mistake

If you moved the wrong slider or knob, use the following procedure to erase the movements of that slider or knob.

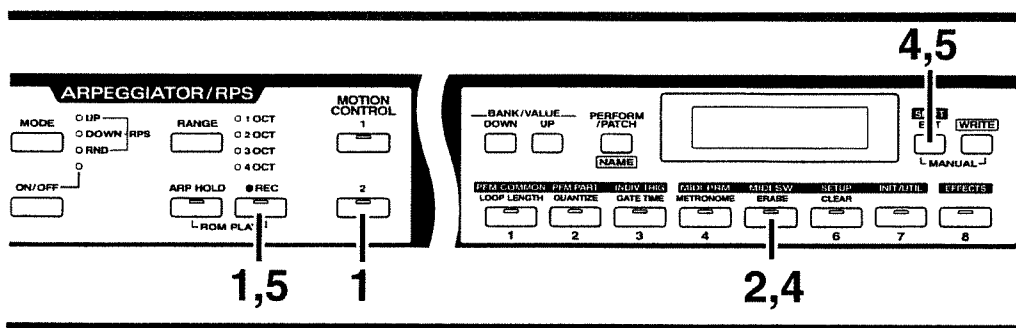

1. Hold down [REC] and press MOTION CONTROL [2].

The [REC] and [2] indicators will blink.

2. Press [ERASE] ([5]).

The indicator will light, and the following display will appear.

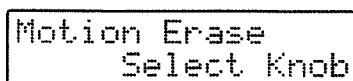

3. Move the slider or knob that you moved by mistake through its entire range of movement.

When you move the slider or knob through its entire range, its data will be erased.

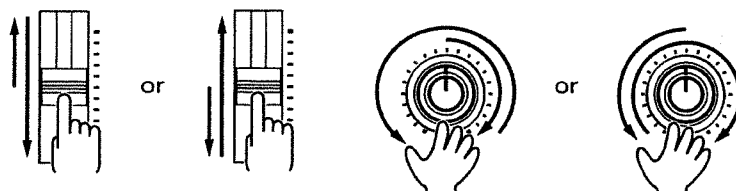

4. After you have erased the movement for the incorrectly-moved slider or knob, press [ERASE] or [EXIT].

The [ERASE] indicator will go dark, and the previous display will reappear. Now you can move the slider/knob to record its movement.

5. To end recording, press [REC] or [EXIT].

The [REC] indicator will go dark, and recording will end.

JP-8000

Advanced Use

Chapter 1. Overview of the JP-8000

How the JP-8000 is Organized

The JP-8000 consists of a controller section, a sound source section, and a sequencer section.

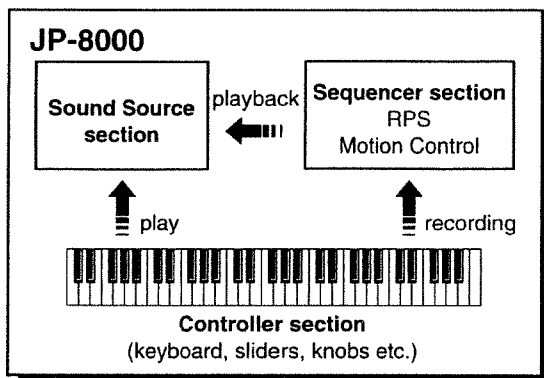

Controller

The Controller section includes the keyboard, the buttons, sliders and knobs on the panel, pitch bend lever / modulation lever, ribbon controller, and pedals connected to the rear panel. By operating these controllers you can play sounds and modify them.

Sound Source

This is the section that actually produces the sound. Messages from the JP-8000's controller and sequencer sections tell the sound source when and how to produce sound. MIDI messages from an external device can also play the sound source.

■ Maximum Polyphony

The JP-8000's sound source is able to produce up to 8 notes (voices) at once. If incoming data requests more than this number of notes, the last-received notes will be given priority, and already-sounding notes will be turned off one by one, starting with the oldest. Please be aware of this when using sounds that have a long decay or when using RPS.

Sequencer

The Sequencer section records keyboard playing and slider movements as MIDI messages, and plays back the recorded MIDI messages. MIDI messages recorded in the sequencer can also be transmitted from the MIDI OUT connector to control external MIDI devices. The JP-8000's sequencer records and plays back RPS patterns and Motions.

Patches and Performances

Patches

On the JP-8000, each musical sound that you can play is called a Patch. The JP-8000 has 256 different Patches: 128 User Patches and 128 Preset Patches. (Refer to "About Memory," p.50.)

Patches have the following structure, and can be modified by using the panel buttons, sliders and knobs to adjust the sound.

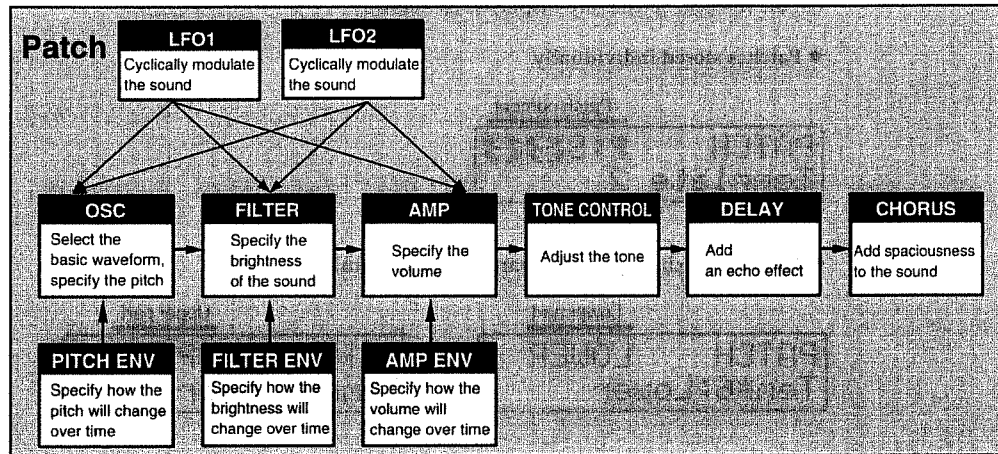

Parts

On the JP-8000, two Patches are always selected, and you can choose to play just one or both Patches. The two Patches are assigned to locations referred to as the *Upper Part* and the *Lower Part*. When you select a Patch, you are actually selecting the Patch that is assigned to one of these Parts. You may think of the Part as being analogous to a musician, and the Patch as the instrument that the musician is playing.

Performances

The Patch selection for the Upper and Lower Parts, settings of the key and panel section, arpeggiator/RPS settings, and a variety of other settings (Performance Parameters, p.85) are stored together as a *Performance*. The JP-8000 has 128 Performances, and as with Patches, they are divided into 64 User Performances and 64 Preset Performances. (Refer to "About Memory," p.50).

Since it is difficult to quickly change a large number of settings while you are playing, you can make things easy for yourself by saving suitable settings as a Performance. Then you can simply select the appropriate Performance to make all the necessary settings at once.

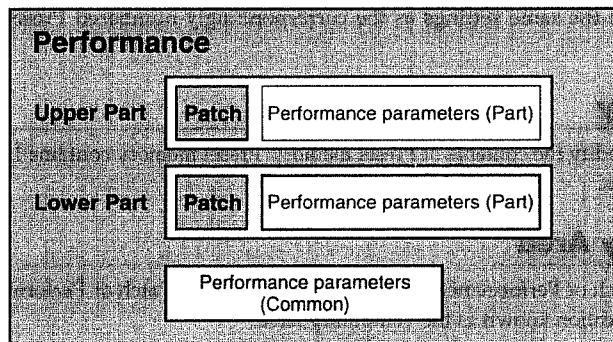

On the JP-8000, the Patch numbers that are stored as part of each Performance do not simply refer to Patches that are kept separately in memory — the actual settings of the entire Patch can be stored in the Performance itself. This means that when you save a Performance, you don't need to perform a separate Save operation to save the Patch settings that are used by that Performance. It also means that if you rewrite the settings of the Patch used by a Performance, other Performances that use that Patch will not be affected.

Patches which are saved as part of a Performance are managed separately from Patches which are stored individually. Each individual Patch has its own Patch number, by which it is identified. However Patches which are saved as part of a Performance have no Patch numbers, and are identified as "the Upper (or Lower) Patch of the Performance".

◆ When you select a Performance

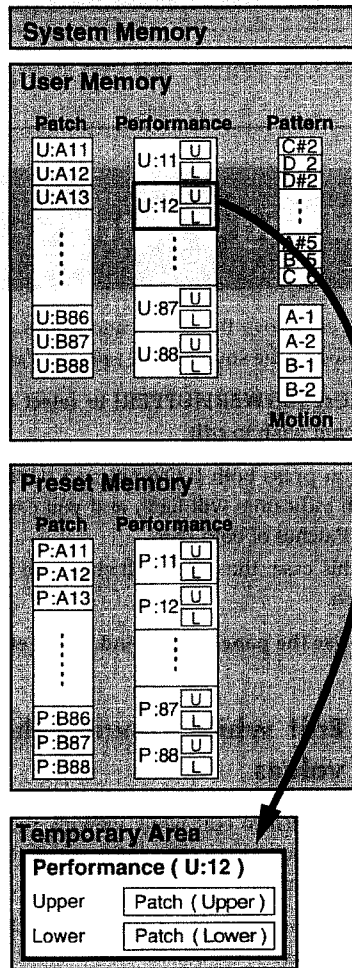

◆ When you select a Patch

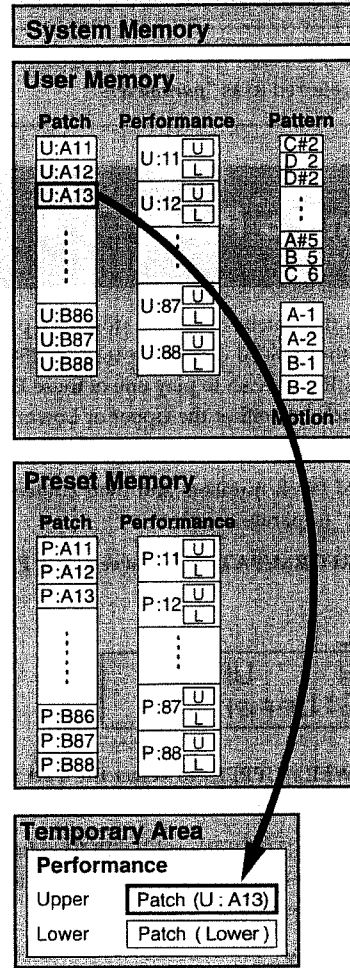

The contents of memory are preserved even when the power is turned off, and can be called up at any time. However the data in the Temporary Area is lost when the power is turned off.

When you modify Patch or Performance settings, your modifications affect only the data in the Temporary Area, and do not directly affect the settings in memory. If you wish to keep the modifications that you have made, you must write the settings from the Temporary Area into User Memory.

In the case of Pattern, Motion, and System settings, your settings are written directly into memory, so you don't need to perform a separate operation to save the data.

Chapter 2. Patch Editing Procedure

In this owner's manual, the process of modifying settings is referred to as "editing," and each of the settings that can be changed are referred to as "parameters."

Selecting a Patch

In addition to the Patches that are stored as part of each Performance, the JP-8000 contains a total of 256 User and Preset Patches. If you wish to play one of these Patches, call the desired Patch into either the Upper or Lower Part of the Performance.

* For a list of Patch numbers and their contents, refer to "Patch List" (separate sheet).

1. Press [PERFORM/PATCH] to access the Patch select display.

Patch



PATCH UPPER
Temp6: Upper

2. Press [LOWER]/[UPPER] to select the Part into which the Patch will be called.

You can press both [LOWER] and [UPPER] simultaneously to make both indicators light, and select the Patch for both Parts at the same time.



to select the Lower Patch



to select the Upper Patch

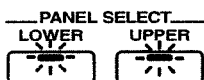

to select the Patch for both Parts simultaneously

3. Use [DOWN]/[UP] to select the bank (U:A1-U:B8, P:A1-P:B8).

The bank indication in the display will change.

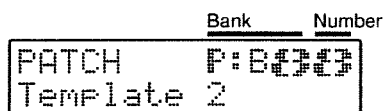

Patch Bank Number
PATCH P:B0003
Template 2

4. Press [1]-[8] to select a number (1-8).

The indicator of the button you pressed will light, and the number in the display will change.

The Patch has now been selected.

Editing a Patch

You can move the sliders and knobs etc. of the front panel to modify the sound of the selected Patch.

1. Use [LOWER]/[UPPER] to select the Part whose Patch you wish to edit.

If you press both [LOWER] and [UPPER] simultaneously, both indicators will light, and you can simultaneously edit the Patches of both Parts.

In this case, the panel will show the settings of the Upper Patch.

2. Use the panel sliders and knobs etc. to edit the Patch.

Edit while viewing the slider/knob values

If you wish to edit while viewing the value of the slider/knob, you can use the following procedure to make the parameter value appear in the display.

* It is not possible to view the [VOLUME] value in the display.

1. Hold down [SHIFT] ([EXIT]), and move the slider/knob.

The value of the slider/knob you moved will appear in the display.

By holding down [SHIFT] and press [DOWN]/[UP] you can modify the value in steps of 1.

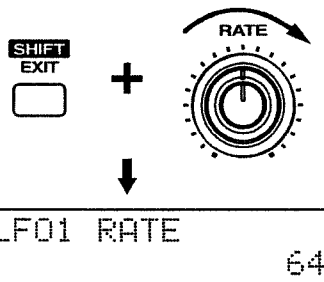

* When a slider/knob is moved, the displayed value may not change in single steps. In this case, you can use [DOWN]/[UP] to set the value.

2. When you release [SHIFT], the previous display will reappear.

* Sometimes, moving a slider/knob will not make the displayed value change in increments of 1. In such cases, use [DOWN]/[UP] to set the value.

Checking the current value of a parameter (Temporary Scope)

When you wish to check the current value of a parameter (the parameter value in the temporary area), use the following procedure to view the value.

1. Hold down [SHIFT] ([EXIT]) and press [INIT/UTIL] ([7]).

The [INIT/UTIL] indicator will light.

2. Press [INIT/UTIL] to access the Temporary Scope page.

```
Temporary Scope
Select Knob
```

3. Move the slider/knob of the parameter whose value you wish to check.

The parameter name and temporary value of the slider/knob you moved will appear in the display.

By pressing [DOWN]/[UP] you can modify the value in steps of 1.

4. To end Temporary Scope, press [EXIT].

You can also view the width of the parameter change assigned to the Ribbon Controller (p.66) or the Velocity (p.68) (Ribbon Scope/Velocity Scope).

1. Press [RIBBON ASSIGN] while appearing the Temporary Scope display.

The indicator will blink, and the display indicate "Ribbon Scope" or "Velocity Scope".

2. Move the slider/knob of the parameter whose value you wish to check.

The Parameter name and the width of the parameter change of the slider/knob you moved will appear in the display.

By pressing [DOWN]/[UP] you can modify the value in steps of 1.

3. When you press [RIBBON ASSIGN], [VELOCITY ASSIGN] or [EXIT], the Temporary Scope display will appear.

Resetting the Sound to the Panel Settings (Manual)

The Manual function matches the parameter values to the current slider/knob positions. When editing a Patch to modify the sound, the parameter values will not always necessarily match the positions of the sliders/knobs. However if the Manual function is used, the sound will match the settings of the sliders/knobs, which is convenient when you are creating a sound from scratch.

If you enter Manual Mode from the Patch select display, the sound of that Patch will change to match the slider/knob positions.

If you enter Manual Mode from the Performance select display, the sound of the Patch of the selected Part will change to match the slider/knob positions.

< Procedure >

Simultaneously press [SHIFT] ([EXIT]) and [WRITE].

The following display will appear, and then an asterisk will blink at the left of the Patch or Performance number.

```
Manual
```

The sound will match the positions of the knobs and sliders.

Storing a Patch

When you have created a sound that you like, you can save the settings. Patch settings can be saved by themselves, independently from Performances. The settings of each section marked with a white numeral in a black box in "Front and Rear Panel" (p.10) can be saved as a User Patch (a Patch starting with "U"). As with Performances, each Patch can be given a name of up to 16 characters.

* The User Patch that was previously stored in that number will be overwritten by the new modified Patch.

1. Press [PERFORM/PATCH] to access the Patch select display.

When you modify the Patch settings, an "*" (asterisk) will appear at the left of the Patch number (just as when a Performance is modified), indicating that the selected Patch is being edited.

2. Press [WRITE].

The following display will appear, and a "_" (cursor) will appear under the Patch number.

```
Write PATCH B##
Template 2
```

To cancel the Patch store operation, press [EXIT].

* If you do not wish to modify the Patch number and the Patch name, skip steps 3-7.

3. Use [DOWN]/[UP] and [1]-[8] to select the storing destination Patch number.

4. Press [NAME] ([PERFORM/PATCH]).

Now you can enter the Patch name.

The cursor will move to the beginning of the second line in the display.

```
Write PATCH B##
Template 2
```

* When the cursor is on the first line, the name of the saving destination Patch will be displayed. When the cursor is on the second line, the name of the newly modified Patch will be displayed.

5. Press [NAME] to move the cursor to the location where you wish to enter a character.

6. Use [DOWN]/[UP] to specify the character.

The following characters can be selected.

space, A-Z, a-z, 0-9, ! " # \$ % & ' () * + , - . / : ;
< = > ? @ [\] ^ _ ` { | }

When inputting characters, the [1]-[8] buttons have the following convenient functions.

- [1] : Move the cursor backward. If the cursor is already at the left edge, it will move to the Patch number location.
- [2] : Display a space at the cursor location.
- [3] : Display an "A" at the cursor location.
- [4] : Display an "a" at the cursor location.
- [5] : Display a "0" at the cursor location.
- [6] : Switch between uppercase and lowercase characters.
- [7] : Insert a space at the cursor location.
- [8] : Delete the character at the cursor location, and shift subsequent characters to the left.

7. Repeat steps 5-6 to enter the Patch name.

8. Press [WRITE].

The display will indicate "Completed" and then the previous display will reappear.

The Patch has now been saved.

■ To Modify the Patch Name of a Patch Stored in a Performance

1. Select the Performance whose Patch name you wish to modify.
2. Press [PATCH/PERFORM] to access the Patch select display.
3. Use [LOWER]/[UPPER] to select the Part whose Patch name you wish to modify.
4. Use the steps 2, 4-6 given above to input the Patch name.
5. Press [EXIT].
6. Press [PERFORM/PATCH] to access the Performance select display.
7. Press [WRITE] twice to store the Performance.

Chapter 3. Functions that Modify the Sound

Chapter 3 explains the sound-related parameters.

All of the parameters explained in this chapter can be set independently for each Patch.

Selecting the Basic Waveform for the Sound (1) (Oscillator 1)

The OSC 1 (Oscillator 1) section selects the waveform that is the basis for the synthesizer's sound.

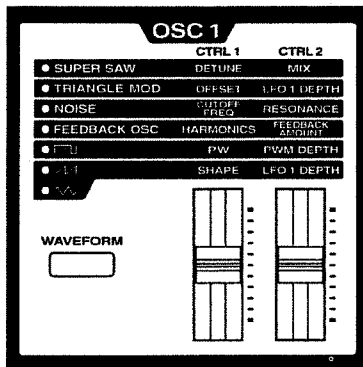

[WAVEFORM] / [CTRL 1]/[CTRL 2] (Control 1/2)

[WAVEFORM] selects the OSC 1 waveform, and [CTRL 1]/[CTRL 2] modify parameters unique to that waveform.

■ SUPER SAW

This sounds like seven sawtooth waveforms sounding simultaneously. Pitch-shifted sounds are added to a central sound. It is especially suitable for creating thick string-type sounds, and allows you to produce a thick sound even when the Key Mode is Single.

DETUNE: Adjust the degree of pitch detuning. As the slider is raised, the pitch will be detuned more greatly, making the sound more spacious.

MIX: Adjust the volume of the detuned sounds relative to the central sound. As the slider is raised, the detuned sounds will become louder, making the sound thicker.

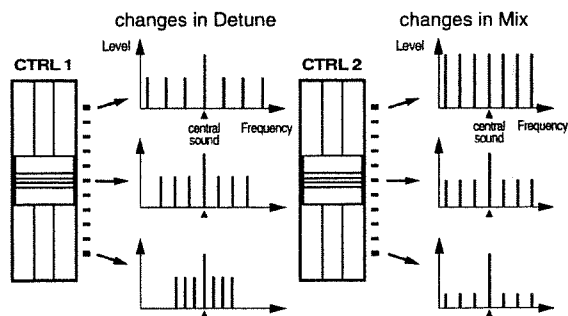

■ TRIANGLE MOD (Triangle Modulation)

This is a modification of a triangle wave, with a large number of overtones. Since there is much energy in the overtones and little in the fundamental, the result is similar to applying an HPF (high pass filter, p.59) to a square wave.

OFFSET: Specify the way in which the triangle wave will be shaped. As the slider is raised, the waveform will be modified more significantly, producing a greater proportion of overtones.

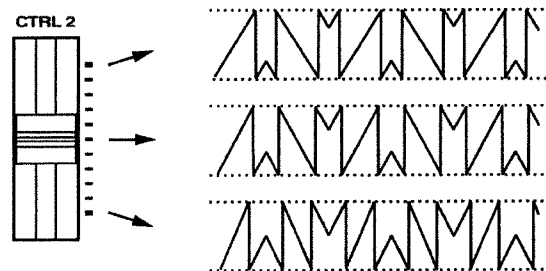

LFO 1 DEPTH: Adjust the amount of effect which LFO 1 (p.63) will have when it is applied to Offset. As the slider is raised, Offset will change more.

■ NOISE

By applying a LFO (low pass filter, p.59) to noise, many different "colors" of noise can be produced.

CUTOFF FREQ: Set the cutoff frequency of the LPF. As the slider is raised, the noise will have more high frequency components, and at the same time the volume will also increase. (Lowering the slider all the way may result in no sound at all.) The noise will also be different depending on the key that you press.

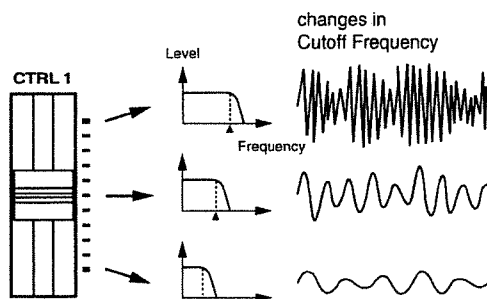

RESONANCE: This regulates the emphasis that is applied to the region at the cutoff frequency. As the slider is raised, the sound will have a greater sense of pitch. If the slider is raised all the way, a sine wave will result.

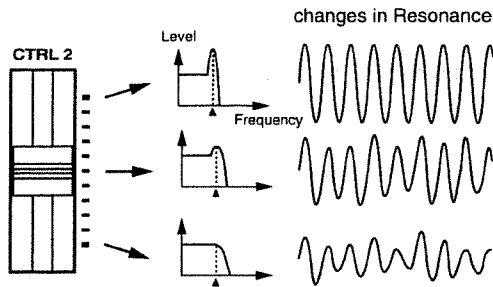

■ **FEEDBACK OSC (Feedback Oscillator)**

This sound is similar to electric guitar feedback, and is especially suitable for solo sounds. When Feedback Oscillator is selected, only one note at a time will sound (MONO, p.70).

FEEDBACK AMOUNT: Adjust the amount of feedback to adjust the level of the harmonics.

HARMONICS: Vary the sound of the harmonics.

■  **(Square wave)**

This sound is similar to a woodwind instrument. It also widely used in making typical "synthesizer" sounds.

PW (Pulse Width): Set the width (pulse width) of the square wave. As the slider is raised, the pulse width will change, producing a thicker sound with more overtones.

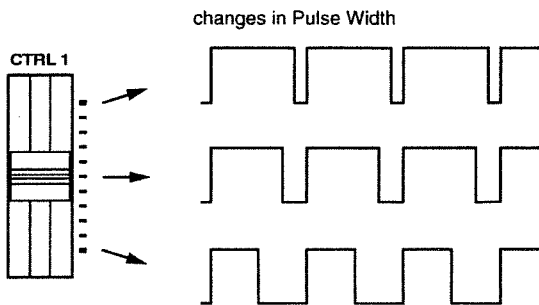

PWM DEPTH: The technique of applying LFO 1 to the Pulse Width is referred to as Pulse Width Modulation (PWM). PWM Depth determines how greatly PWM will be applied. As the slider is raised, Pulse Width will be modulated more greatly, creating a broader and more "smeared" sound.

■  **(Sawtooth wave)**

This waveform is used for nearly all instruments except for woodwinds. Many sounds unique to synthesizers can be created using this waveform.

SHAPE: Specify the degree to which the sawtooth wave will be deformed. When the slider is at either end of its range, the sound will have a strong fundamental, and will be suitable for thick bass sounds etc. When the slider is in the center position, the sound will be thin, as though an HPF were applied to it.

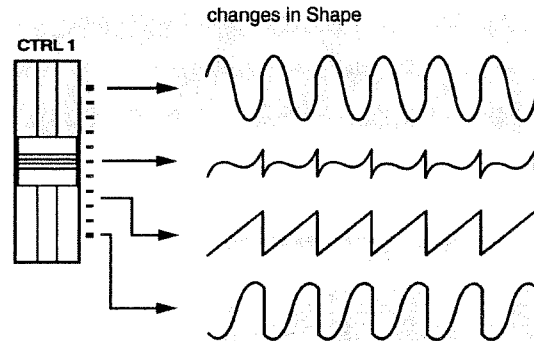

LFO 1 DEPTH: When LFO 1 is applied to Shape, this parameter specifies how greatly Shape will be affected. As the slider is raised, Shape will be affected more greatly.

● **Shape for sawtooth waveforms**

Sawtooth wave sounds on different synthesizers differ in subtle ways, and the sound of the sawtooth wave often determines the character of the synthesizer itself.

On the JP-8000 you can use the Shape parameter to make fine adjustments to sawtooth wave sounds to create a variety of sawtooth waves, for an even greater range of sound-creating possibilities.

■  **(Triangle wave)**

This is a simple sound with few overtones. It is used for creating flute sounds etc.,

SHAPE: Specify the degree to which the triangle wave will be deformed. As the slider is raised, the waveform will be modified more greatly, producing a sound with more overtones. This will produce a sound similar to square wave with an LPF (low pass filter, p.59) applied to it.

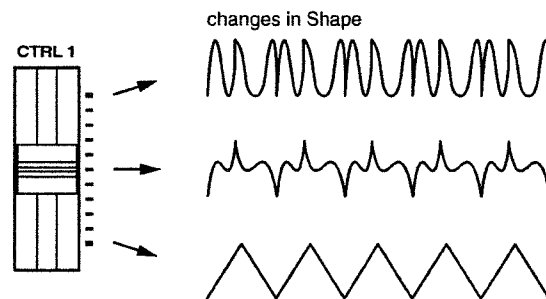



LFO 1 DEPTH: When LFO 1 is applied to Shape, this parameter specifies how greatly Shape will be affected. As the slider is raised, Shape will be affected more greatly.

Selecting the Basic Waveform for the Sound (2) (Oscillator 2)

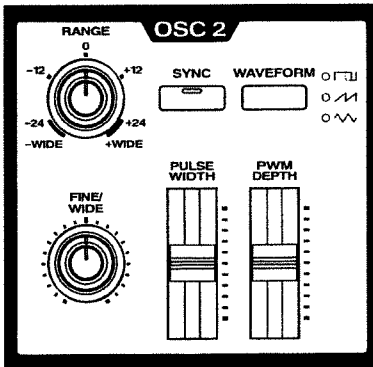
In the same way as for the OSC 1 section, this selects the waveform that will be the basis of the sound. By combining OSC 1 and OSC 2, a variety of sounds can be created.



[WAVEFORM]

Select one of three waveforms for OSC 2:  (square wave),  (sawtooth wave), or  (triangle wave). For details on each waveform, refer to "Selecting the Basic Waveform for the Sound (1) (Oscillator 1)" (p.55).

[SYNC]

This switches sync on/off. When this is on, the output waveform of OSC 2 will be synchronized to the output waveform of OSC 1 ("Functions using OSC 1 and OSC 2" (p.59)). I.e., each time the OSC 1 waveform returns to the beginning of its period, OSC 2 will also be forcibly reset to the beginning of its period, producing a complex waveform.

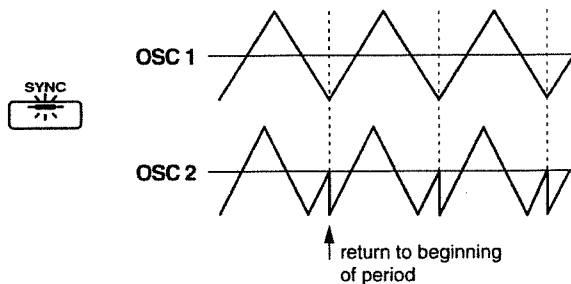

* If the effect of Sync is difficult to notice, rotate [OSC BALANCE] toward the right (toward OSC 2).

● Tonal changes using Sync

If you turn [SYNC] on and modify [RANGE] or [FINE/WIDE], the tone of OSC 2 will change in various ways while the pitch remains the same.

[RANGE]

Specify the pitch of OSC 2 in relation to OSC 1 over a range of +/-24 semitones (+/-2 octaves). As the knob is rotated toward the right the pitch of OSC 2 will rise. As it is rotated toward the left the pitch of OSC 2 will fall. With a setting of 0, OSC 2 will have the same pitch as OSC 1.

With settings of -WIDE or +WIDE, the [FINE/WIDE] knob can adjust the pitch of OSC 2 over a +/-4 octave range. However in this case, you must be sure to rotate the knob fully right or left.

* To make it easy for you to make accurate settings, the -24, -12, 0, +12 and +24 settings have a greater width than other settings.

[FINE/WIDE] (Fine tune/Wide)

When the [RANGE] setting is -24- +24, this knob provides a +/-50 cent (+/- 1/2 semitone) adjustment to the pitch specified by the [RANGE] setting. As this knob is rotated to the right, the OSC 2 pitch will rise. As it is rotated to the left, the OSC 2 pitch will fall. When this knob is in the center position, the pitch will be as specified by the [RANGE] setting.

When the [RANGE] knob is in the fully left (-WIDE) or fully right (+WIDE) position, this knob can be rotated toward the left to adjust the pitch -4-0 octaves, or toward the right to adjust the pitch 0- +4 octaves.

◆ When [RANGE] is -24- +24



◆ When [RANGE] is -WIDE

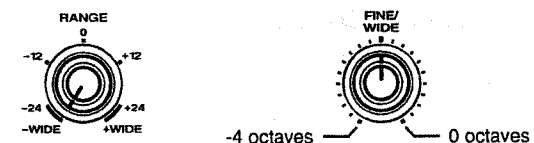

◆ When [RANGE] is +WIDE

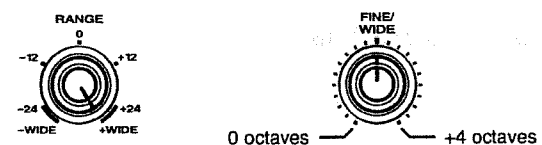

* To make it easy for you to make accurate settings, the center setting has a greater width.

● Giving the sound more spaciousness

If you select the same waveform for OSC 1 and OSC 2, set [RANGE] to 0 and use [FINE/WIDE] to create a slight difference in pitch, the sound will appear more spacious (the Detune effect).

[PULSE WIDTH]

This sets the pulse width when Waveform is set to square wave. For details on Pulse Width, refer to "Selecting the Basic Waveform for the Sound (1) (Oscillator 1)" (p.55).

[PWM DEPTH]

This sets the degree to which Pulse Width Modulation (PWM) will be applied when Waveform is set to square wave. For details on PWM, refer to "Selecting the Basic Waveform for the Sound (1) (Oscillator 1)" (p.55).

Modifying the Waveform and Pitch of the Sound (Oscillator Common)

In the OSC COMMON (Oscillator Common) section you can make settings related to the OSC 1 and OSC 2 sections, and settings related to the pitch.

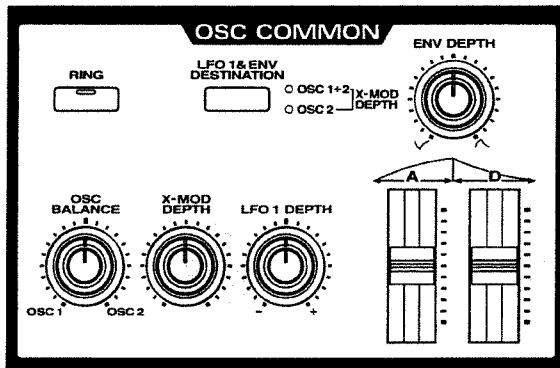

[OSC BALANCE] (Oscillator Balance)

This adjusts the balance between OSC 1 and OSC 2. As the knob is rotated toward the left, the volume of OSC 1 will become louder. As it is rotated toward the right the volume of OSC 2 will become louder. In the center position, OSC 1 and OSC 2 will have the same volume.

[RING] (Ring Modulator)

This switches the Ring Modulator on/off. When this is on, the indicator will light, and the sound will become more metallic. This is suitable for creating bell sounds, etc.

Ring Modulator multiplies the OSC 1 and OSC 2 waveforms to create a sound which includes new overtones that were not present in either of the original waveforms ("Functions using OSC 1 and OSC 2", p.59). Since large numbers of inharmonic overtones are present, the sound will have a dissonant, un-pitched feeling.

- * If the Ring Modulator effect is difficult to hear, rotate [OSC BALANCE] toward the right (the OSC 2 position).

[X-MOD DEPTH] (Cross Modulation Depth)

Cross Modulation is when OSC 2 modify the frequency of OSC 1 ("Functions using OSC 1 and OSC 2", p.59). [X-MOD DEPTH] adjusts the depth of this Cross Modulation. As the knob is rotated toward the right, the sound of OSC 1 will become more complex, with more overtones, and will be suitable for creating metallic sounds and sound effects.

- * If the OSC1 section [WAVEFORM] is set to SUPER SAW or NOISE, the Cross Modulation effect can not be obtained.
- * If the Cross Modulation effect is difficult to hear, rotate [OSC BALANCE] toward the left (the OSC 1 position).

● Tonal changes using Cross Modulation

Leave [X-MOD DEPTH] raised, and move [RANGE] or [FINE/WIDE] to modify the tone in various ways without changing the pitch.

[LFO 1 & ENV DESTINATION] (LFO 1 & Envelope Destination)

Select one of the following three possibilities to specify how LFO 1 (p.63) and the envelope generator will be applied.

OSC 1+2 (Oscillator 1+2): LFO 1 and the envelope will be applied to OSC 1 and OSC 2.

OSC 2 (Oscillator 2): LFO 1 and the envelope will be applied to the pitch of OSC 2.

X-MOD DEPTH (Cross Modulation Depth): LFO 1 and the envelope will be applied to Cross Modulation Depth. In this case, both the OSC 1+2 and the OSC 2 indicators will light.

- * If you have selected Cross Modulation Depth, read "Cross Modulation Depth" for "Pitch" in the following explanations.

[LFO 1 DEPTH]

Specify the depth for when LFO 1 is applied to the pitch. As the knob is rotated from the center position toward the right, the change will become greater. As it is rotated from the center toward the left, the LFO 1 waveform will be inverted, and change will become greater in the opposite direction. When the knob is in the center position, LFO 1 will not affect the pitch.

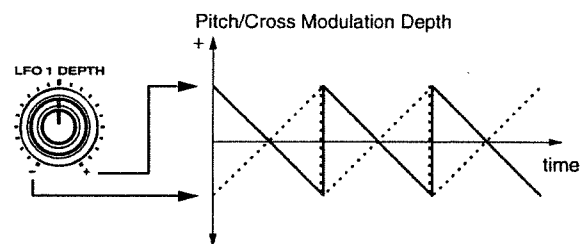

[ENV DEPTH] (Envelope Depth)

Specify the depth of the pitch envelope. As the knob is rotated from the center position toward the right, the change will become greater. As it is rotated from the center toward the left, the envelope shape will be inverted, and change will become greater in the opposite direction. When the knob is in the center position, the pitch envelope will not affect the pitch.

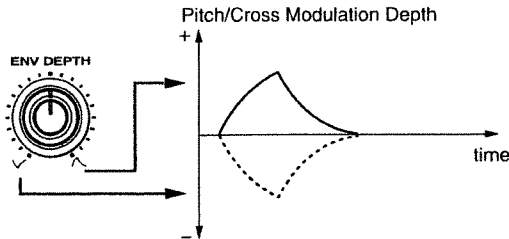

* When applying a positive (+) envelope to Cross Modulation, the effect will be more apparent if [X-MOD DEPTH] is set to a low setting. When applying a negative (-) envelope, the effect will be more apparent if [X-MOD DEPTH] is set to a high setting.

[A] (Attack Time) / [D] (Decay Time)

Specify the Attack Time and Decay Time of the pitch envelope. The value will increase as the slider is raised.

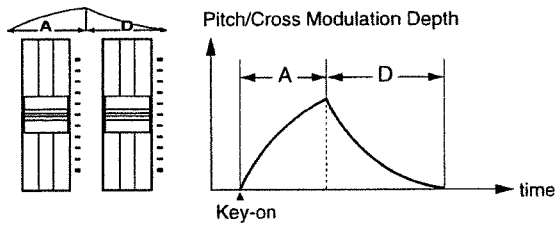

A: The time from when the key is pressed until the maximum pitch change is reached.

D: The time from when the maximum pitch change is reached until normal pitch is reached.

● Functions using OSC 1 and OSC 2

Functions which use OSC 1 and OSC 2 (Sync, Ring Modulator, Cross Modulation) are applied as shown in the following diagram to modify the sound.

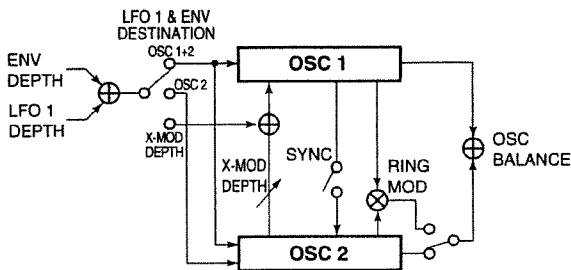

Modifying the Brightness (Filter)

Sound consists of partials (overtones) at many frequencies. The filter allows a specific range of frequencies to pass (or restricts the way that they pass), thereby modifying the brightness of the sound. The FILTER section allows you to select the Type of this filter, and to make the output waveform change in various ways to modify the brightness.

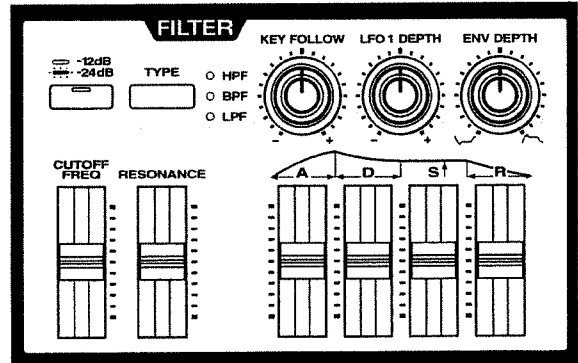

[TYPE]

Select one of the following three filter types.

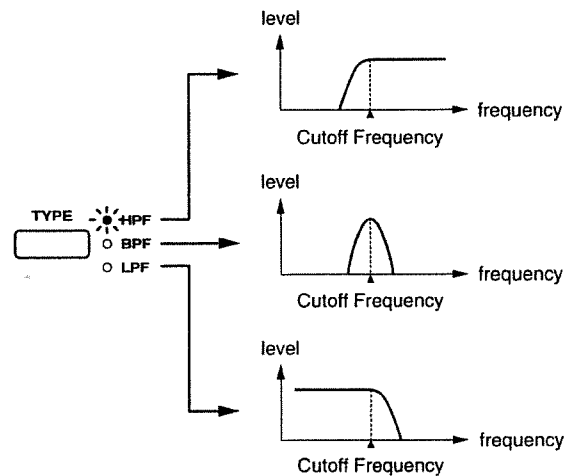

HPF (High Pass Filter): This type of filter allows partials higher than the cutoff frequency to pass. This is useful when you want the sound to be bright and sharp.

BPF (Band Pass Filter): This type of filter allows partials in the region of the cutoff frequency to pass. This will emphasize the mid-range, and is suitable for creating sounds with a unique character.

LPF (Low Pass Filter): This type of filter allows partials lower than the cutoff frequency to pass. This is the most common type of filter, and is useful when you want to make the sound more mellow.

[-12dB/-24dB] (Cutoff Slope)

This selects the slope of the filter.

When the indicator is dark the slope will be more gradual (-12 dB/oct). When [-12dB/-24dB] is pressed to make the indicator light, the filter will have a steep slope (-24 dB/oct), making a clearer distinction between the overtones which pass through and those which do not.

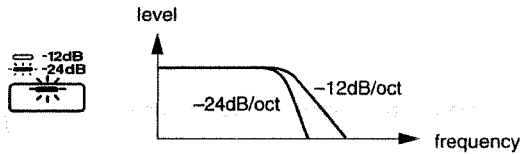

[CUTOFF FREQ] (Cutoff Frequency)

This sets the cutoff frequency of the filter. Cutoff frequency is the parameter which specifies the frequency at which the filter will begin restricting (cutting off) the partials. By modifying the cutoff frequency you can control the brightness of the sound. As the slider is raised, the cutoff frequency will become higher, producing a brighter tone.

● Filter Type and Cutoff Frequency

When the filter is set to HPF, raising the cutoff frequency will decrease the lower partials, making the sound brighter. At the same time, the volume will also decrease. With high settings of this parameter, some waveforms may produce no sound at all.

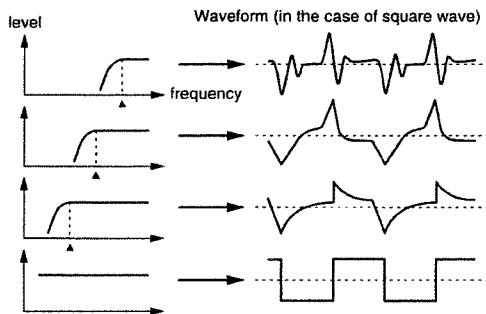

When the filter is set to BPF, only the partials in the frequency range specified by the cutoff frequency will be allowed to pass. With high settings of this parameter, some waveforms may produce no sound at all.

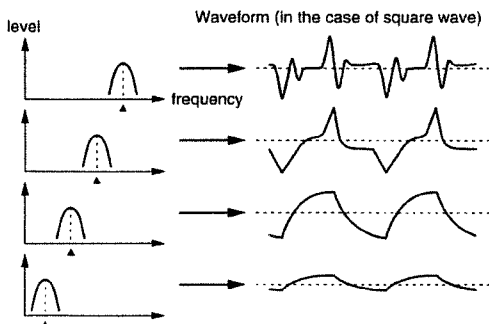

When the filter is set to LPF, lowering the cutoff frequency will decrease the upper partials, making the sound more mellow. At the same time, the volume will also decrease.

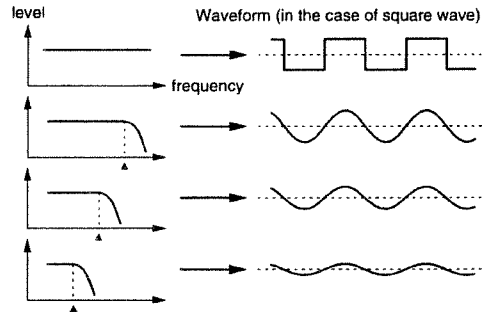

[RESONANCE]

As this slider is raised, the partials in the region of the cutoff frequency will be emphasized, producing a distinctive sound. If the slider is raised even further, a new sound will be heard in addition to the sound of OSC 1 and OSC 2 (this is known as oscillation), so normally you should avoid excessively high settings of this parameter.

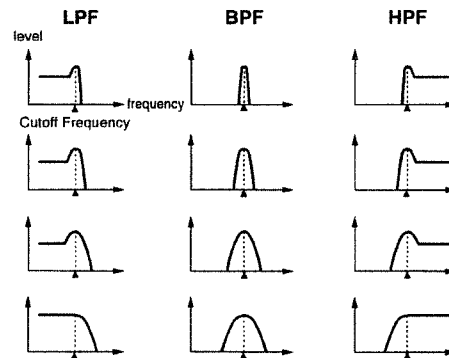

[KEY FOLLOW]

This sets the Key Follow depth for the filter. When the filter is a LPF, a central setting of Key Follow will cause the cutoff frequency to remain fixed, and unaffected by the pitch of the sound (i.e., the note that you played). This means that as you play higher notes, there will be fewer partials in the sound, making it increasingly more mellow in comparison to lower notes. As the knob is rotated toward the right, higher notes will have a correspondingly higher cutoff frequency, allowing high notes to remain bright. Key Follow to +32, the sound will be the same brightness for all keys. Conversely, when the knob is rotated toward the left of center, playing higher notes will cause the cutoff frequency to become lower, meaning that high notes will be even more mellow than when the knob is in the center position.

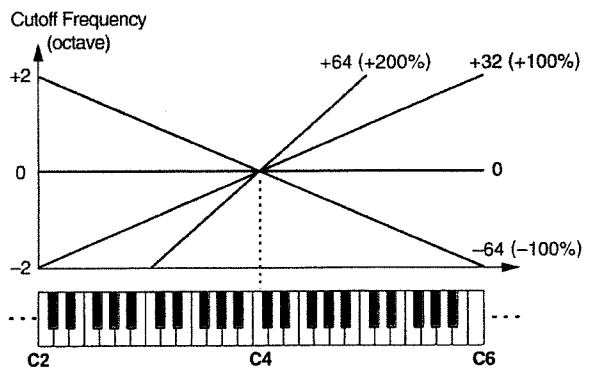
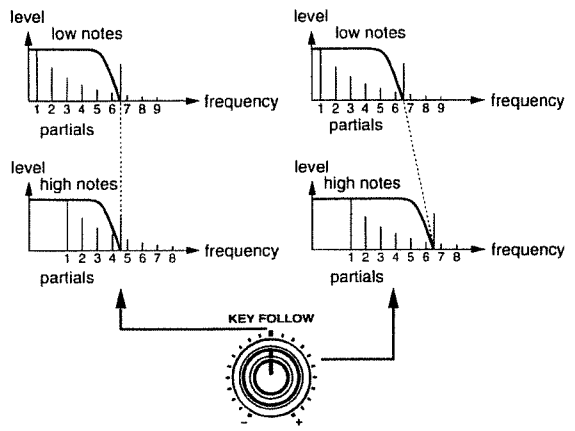

For both HPF and BPF, raising the Key Follow setting will allow you to play all notes with the same brightness.

- * When [CUTOFF FREQ] is set to the center position, the Key Follow effect will be clearly noticeable.

● Ways to use Key Follow

If you are playing a brass-type sound for a solo, you might rotate [KEY FOLLOW] to the left of center so that high notes will be more mellow. If you are playing the brass sound as a backing part, you might rotate [KEY FOLLOW] to the right of center so that the tone will remain flat.

[LFO 1 DEPTH]

When LFO 1 (p.63) is applied to cutoff frequency, this parameter determines the depth of the effect. As the knob is rotated to the left of center, the effect will increase. As the knob is rotated to the right of center, the LFO 1 waveform will be inverted, and the effect will increase. With a setting in the center position, LFO 1 will not affect the cutoff frequency (brightness).

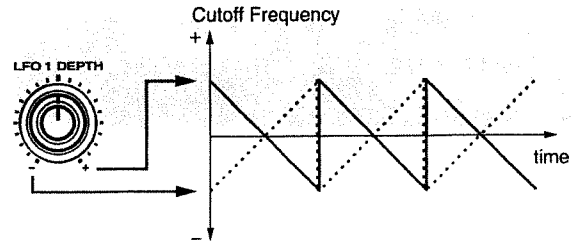

[ENV DEPTH] (Envelope Depth)

This adjusts the depth of the filter envelope. As the knob is rotated to the right of center, the filter envelope will have a greater effect. As the knob is rotated to the right of center, the filter envelope will be inverted, and it will have a greater effect. With a setting in the center position, the filter envelope will not affect the brightness.

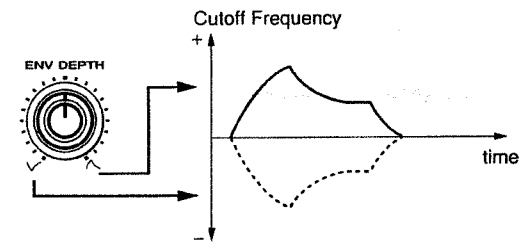

- * If the Individual Trigger switch (p.88) is ON, and the Trigger Destination is FILTER or FILTER&, there will be no filter envelope effect if you play only the keyboard of the JP-8000 (the Upper Part when the Key Mode is Split). If you want the filter envelope to have an effect, turn the Individual Trigger switch OFF.
- * When applying a positive (+) envelope, the effect will be more apparent if [CUTOFF FREQ] is set to a low setting. When applying a negative (-) envelope, the effect will be more apparent if [CUTOFF FREQ] is set to a high setting.

[A] (Attack Time) / [D] (Decay Time) / [S] (Sustain Level) / [R] (Release Time)

These parameters set the Attack Time, Decay Time, Sustain Level, and Release Time of the filter envelope. Raising a slider will increase the corresponding value.

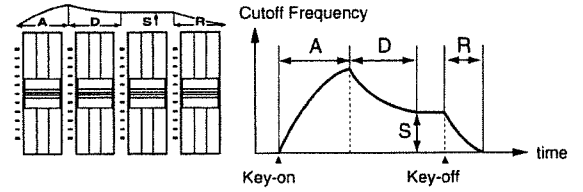

- A: The time from when the note is played until the maximum brightness is reached
- D: The time until the brightness reaches a steady level
- S: The level at which the brightness will remain steady
- R: The time from when the note is released until the sound disappears

Modifying the Volume (Amplifier)

The parameters of the AMP (Amplifier) section modify the volume, and how the sound begins and ends.

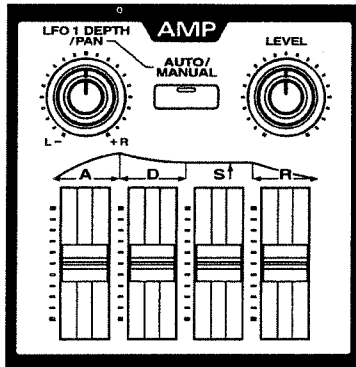

[LEVEL]

Specify the volume of the Patch. The volume will increase as the knob is rotated toward the right.

The [LEVEL] setting is saved in the Patch, so if you want each Patch to have a different volume, you can set each Patch accordingly. In contrast, [VOLUME] is used to adjust the volume of the entire JP-8000.

[AUTO/MANUAL]

Select one of three ways in which the volume or pan (stereo position) will change.

OFF (dark): LFO 1 (p.63) will cyclically modulate the volume.

AUTO PAN (lit orange): LFO 1 will cyclically shift the panning between left and right.

MANUAL PAN (lit red): Adjust [LFO1 DEPTH] to pan the sound to left or right.

- * The LFO 1 Fade Time setting has no effect on Auto Pan.
- * In the following cases, the Auto Pan and Manual Pan effects will be unavailable.
 - ◆ When the sound is being input in MONO from the OUTPUT jacks.
 - ◆ When Output Assign (p.85) is set to PARALLEL OUT.

[LFO 1 DEPTH/PAN]

When [AUTO/MANUAL] is OFF (dark) or Auto Pan (lit orange), this parameter determines how greatly LFO 1 will be applied to Level or Pan. Rotating the knob toward the right of center will produce greater change. Rotating the knob toward the left of center will invert the LFO 1 waveform, and produce greater change in the opposite direction. With a central setting, LFO 1 will not affect level or pan.

When [AUTO/MANUAL] is set to Manual Pan (lit red), rotating the knob toward the right of center will pan the sound toward the right, and rotating it toward the left of center will pan the sound toward the left. With a central setting, the sound will be heard from the center.

- ◆ When [AUTO/MANUAL] is dark / lit orange

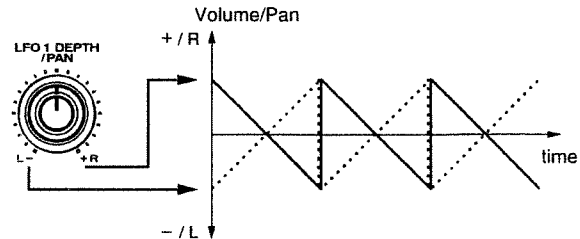

- ◆ When [AUTO/MANUAL] is lit red

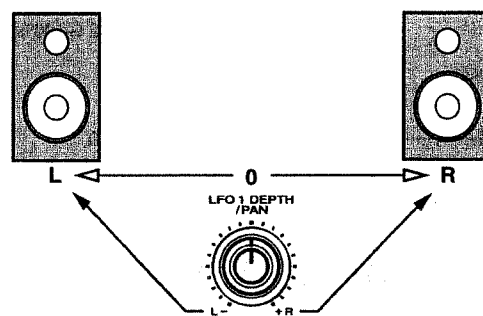

[A] (Attack Time) / [D] (Decay Time) / [S] (Sustain Level) / [R] (Release Time)

These parameters set the Attack Time, Decay Time, Sustain Level, and Release Time of the amplifier envelope. Raising a slider will increase the corresponding value.

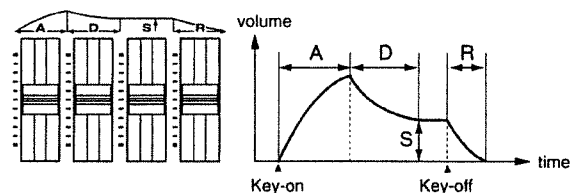

A: The time from when the note is played until the maximum volume is reached

D: The time until the volume reaches a steady level

S: The level at which the volume will remain steady

R: The time from when the note is released until the sound disappears

- * If the Individual Trigger switch (p.88) is ON, and the Trigger Destination is AMP or FILTER&, the amplitude envelope will not have an effect nor will there be any sound if you play only the keyboard of the JP-8000 (the Upper Part when the Key Mode is Split). If you want notes to sound, turn the Individual Trigger switch OFF.

● **Example of different envelopes**

The following two Patches of the JP-8000 contain typical amplifier envelope settings.

If you wish to create a decay-type sound like that of a piano, or a sustain-type sound like that of an organ, an easy way to do so is to select one of the following Patches and adjust the sliders and knobs to your liking.

P: B87: Decay-type envelope

P: B88: Sustain-type envelope

Modulating the Sound (LFO 1)

The LFO 1 (Low Frequency Oscillator) section outputs a waveform, just as the OSC 1 and OSC 2 sections. However while the OSC 1 and OSC 2 waveforms are used to produce the sound itself, the LFO 1 waveform is used to cyclically modulate the pitch, brightness, or volume of the sound.

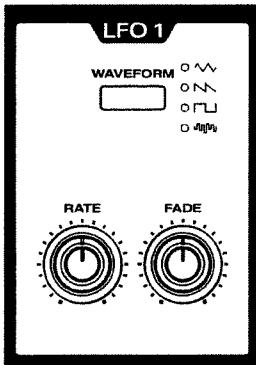

[WAVEFORM]

Select one of the following four choices as the LFO 1 output waveform. The sound will be modulated in the way indicated by the selected LFO 1 waveform.

(Triangle wave): The sound will be modulated continuously. This waveform is suitable for vibrato effects, etc.

(Sawtooth wave): When the sound reaches its minimum setting, it will then return to the maximum, and then begin to fall again. If the [LFO 1 DEPTH] in the OSC COMMON, FILTER, and AMP sections is rotated to the left of center, the direction will be inverted. (When the sound reaches its maximum setting, it will return to the minimum and then begin to rise again.)

(Square wave): The sound will alternate between two settings.

(Sample and hold): The sound will switch randomly between various settings.

● **Ambulance siren**

An ambulance siren effect can be produced by selecting square wave for LFO 1 and modulating the pitch.

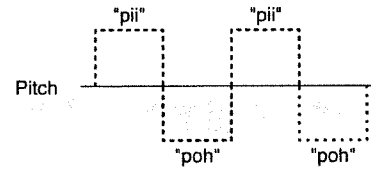

Increasing the [RATE] setting will produce a sound similar to a telephone ringer.

The width of the pitch change can be adjusted by the OSC COMMON section parameter [LFO 1 DEPTH].

[RATE]

This sets the modulation speed for LFO 1. At the knob is rotated to the right, the modulation speed will increase.

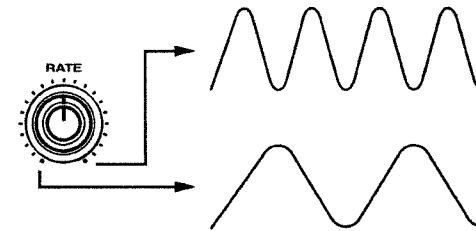

* The LFO 1 Rate can be synchronized to the MIDI Clock messages of a sequencer, etc. For details refer to "LFO Sync" (p.87), and "Synchronizing Chorus, Delay, and LFO 1" (p.96).

[FADE] (Fade Time)

Specify the time from when you press the key and the LFO 1 begins to apply until the modulation reaches the amount specified by the Depth setting of each section. Rotating the knob toward the right will lengthen the time until the full amount of modulation is reached.

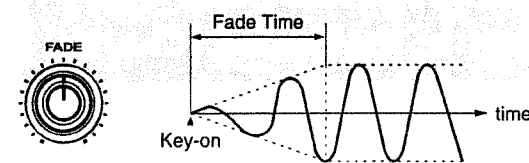

Modifying the Tone (Tone Control)

The TONE CTRL. (Tone Control) section lets you emphasize or attenuate the low or high ranges of the sound to adjust the tone to your preference.

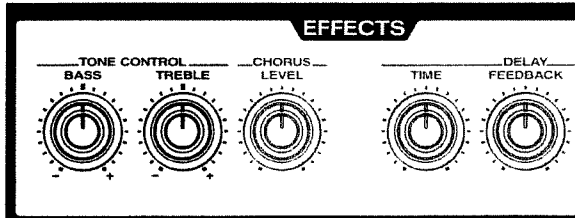

[BASS]

This knob emphasizes/attenuates the low frequency range. Rotating the knob toward the right of center will emphasize the low frequency range, producing a more solid sound. Rotating it toward the left of center will attenuate the low frequency range.

[TREBLE]

This knob emphasizes/attenuates the high frequency range. Rotating the knob toward the right of center will emphasize the high frequency range, producing a more crisp sound. Rotating it toward the left of center will attenuate the high frequency range.

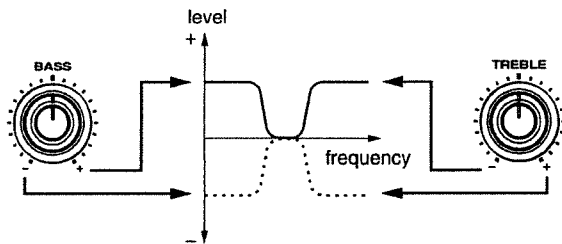

Adding Spaciousness and Depth to the Sound (Chorus)

Chorus is a function that adds spaciousness and depth to the sound. The settings of the CHORUS section determine how the Chorus effect is applied. You can also select the type of chorus in the [EFFECTS] setting in the lower line of the display.

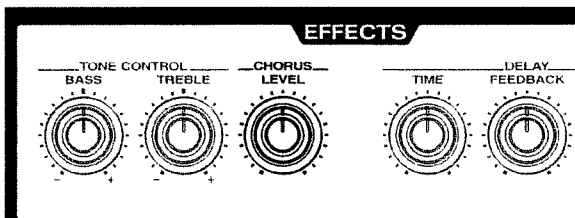

[LEVEL]

Specify the amount of the chorus effect. As the knob is rotated toward the right, chorus will be applied more heavily.

Changing the type of Chorus (Chorus Type)

The type of chorus can be changed as appropriate for the sound or song that you are playing. The JP-8000 provides 12 types of chorus.

SUPER CHORUS SLW: Slow chorus with deep modulation.

SUPER CHORUS MID: Chorus with medium modulation.

SUPER CHORUS FST: Fast chorus with shallow modulation.

SUPER CHORUS CLR: Chorus with a transparent feeling. More chorus will be applied to the high range, producing a light sensation.

FLANGER SLOW: Flanger with delayed modulation.

FLANGER DEEP: Flanger with deep modulation.

FLANGER FAST: Flanger with fast modulation.

DEEP PHASING SLW: Slow phasing with deep modulation.

JET PHASING: An effect reminiscent of a jet airplane taking off and landing.

TWISTING: An effect as though the sound were being twisted.

FREEZE PHASE 1/2: A short delay. This is effective in adding a metallic resonance.

1. Hold down [SHIFT] ([EXIT]) and press [EFFECTS] ([8]).

The [EFFECTS] indicator will light.

2. Press [EFFECTS] to access the Chorus Type setting page.

```
Chorus Type
SUPER CHORUS SLW
```

3. Use [DOWN]/[UP] to select the desired Chorus Type.

4. When you have finished, press [EXIT].

The previous display will reappear.

The Chorus Type has now been selected.

* The chorus Rate (speed of modulation) can be synchronized to MIDI Clock messages from a sequencer, etc. For details refer to "Chorus Sync" (p.86), and "Synchronizing Chorus, Delay, and LFO 1" (p.96).

Adding an Echo Effect (Delay)

Delay is an effect that adds echoes to the sound. The settings of the DELAY section affect how the delay sound is heard. You can also select the type of delay in the [EFFECTS] setting in the lower line of the display.

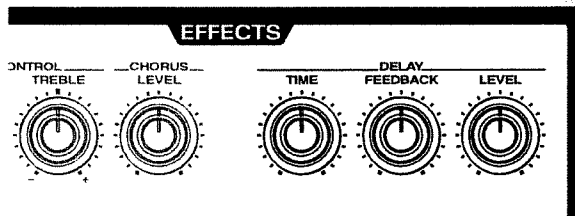

[LEVEL]

Specify the amount of the delay sound relative to the original (undelayed) sound. As the knob is rotated toward the right, the delay sound will become louder.

[TIME] (Delay Time)

Specify the time (interval between delays) from when a key is pressed to play a sound until when the delayed sound is heard. As the knob is rotated toward the right, the time will become longer.

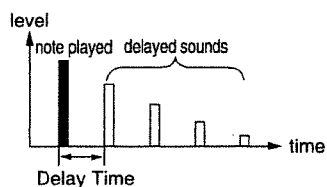

* It is also possible to synchronize the Delay Time to the MIDI Clock messages from a sequencer, etc. For details refer to "Delay Sync" (p.86), and "Synchronizing Chorus, Delay, and LFO 1" (p.96).

[FEEDBACK]

Specify the amount of feedback for the delayed sound; i.e., the way in which the delayed sounds will gradually diminish over time. With small amounts of feedback, the delayed sounds will diminish quickly after you release the key. As the knob is rotated toward the right, the feedback will increase, and the delayed sounds will diminish over a longer interval after you release the key.

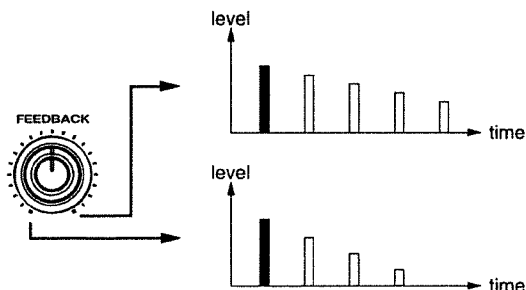

Changing the type of delay (Delay Type)

The type of delay can be changed as appropriate for the sound or song that you are playing. The JP-8000 provides 5 types of delay.

PANNING L->R: The delayed sound is assigned to left and right in the order of left → right.

PANNING R->L: The delayed sound is assigned to left and right in the order of right → left.

PANNING SHORT: The delayed sound is assigned to left and right in the order of left → right. The delay time is 1/4 of PANNING L->R.

MONO SHORT: The delayed sound is assigned to the center. The delay time is the same as PANNING SHORT.

MONO LONG: The delayed sound is assigned to the center. The delay time is twice that of PANNING L->R/R->L.

* The delay time will differ depending on the delay type. When [TIME] is rotated fully toward the right, the delay time for each delay type will be as follows.

- MONO LONG= 1250 ms (1.25 seconds)
- PANNING L->R/R->L= 625 ms
- PANNING SHORT, MONO SHORT= 156 ms

* In the following cases, the panning delay effect cannot be obtained.

- ◆ If the sound is being sent from the output jacks in MONO.
- ◆ If Output Assign (p.85) is set to PARALLEL OUT.

1. Hold down [SHIFT] ([EXIT]) and press [EFFECTS] ([8]).

The [EFFECTS] indicator will light.

2. Press [EFFECTS] to access the Delay Type setting page.

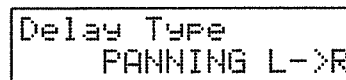

3. Use [DOWN]/[UP] to select the desired Delay Type.

4. When you have finished, press [EXIT].

The previous display will reappear.

The Delay Type has now been selected.

● Effect connections

The effects (Tone Control, Delay, Chorus) of the JP-8000 are connected as follows.

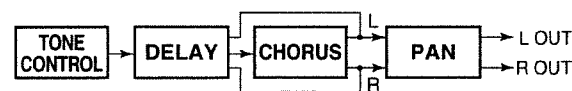

Chapter 4. Taking Advantage of the Performance Functions

In addition to the parameters which were explained in chapter 3, the JP-8000 provides a variety of functions that you can use to modify the sound in real-time.

Controlling Multiple Parameters Simultaneously (Ribbon Controller)

The ribbon controller allows the sound to be modified as if many sliders/knobs were moved at the same time. Also, you can press or release a given spot on the ribbon controller to create instantaneous tonal changes that would be impossible to create by moving the slider/knobs.

Other than Relative (p.67) and Hold (p.67), all ribbon controller settings can be made independently for each Patch. The Relative and Hold settings apply to the entire JP-8000.

■ Parts to which the ribbon controller effect will apply

The Parts to which the ribbon controller effect will apply will depend on the Key Mode.

Single, Split: The effect will apply to the Patch of the Part selected by Panel Select.

Dual: Regardless of the Panel Select setting, the effect will apply to the Patches of both Parts. If you wish to apply an effect only to the Patch of one or the other Part, you can erase the ribbon controller settings of the other Patch.

■ Parameters which can be modified by the ribbon controller

The parameters of any sliders/knobs except for [VOLUME] and [TEMPO] can be modified by the ribbon controller.

When controlling following parameters by Ribbon Controller, a positive (+) setting will allow control in the positive (+) direction, and a negative (-) setting will allow control in the negative direction. It is not possible to control the parameter through the center (0) position.

- ◆ [LFO1 DEPTH] of the OSC Common section
- ◆ [ENV DEPTH] of the OSC Common section
- ◆ [LFO1 DEPTH] of the Filter section
- ◆ [ENV DEPTH] of the Filter section
- ◆ [LFO1 DEPTH/PAN] of the Amp section (except when Manual Pan)
- ◆ [DEPTH] of the LFO2 section

Ribbon Controller Settings

Here you can specify the range over which the parameter will change when you move your finger from the center to the right edge of the ribbon controller. The range of change that occurs when you move from the center to the left edge will be set automatically.

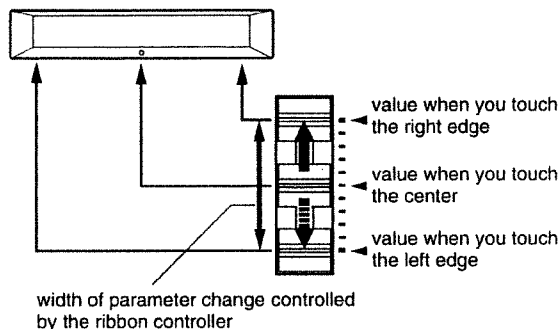

By moving the slider/knob in the opposite direction, you can also make settings so that the parameter value decreases when the ribbon is touched further toward its right edge.

1. Move the sliders/knobs to create the sound that will be heard when the ribbon controller is touched in the center (or when the ribbon controller is not touched).

These operations will determine the basic values from which the various parameters will begin to change.

2. Press [RIBBON ASSIGN].

The indicator will blink, and the ribbon controller assign page will appear.

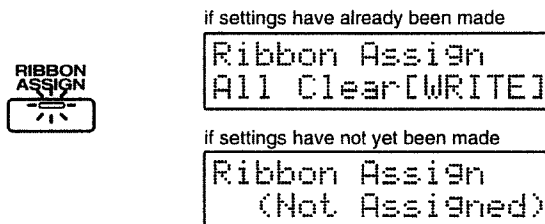

To cancel the settings, press [RIBBON ASSIGN] or [EXIT].

3. Create the sound that will be heard when the ribbon control is touched at the right edge.

These operations will determine the width over which the parameters will change.

4. Press [RIBBON ASSIGN] or [EXIT].

The indicator will change to lit, and the previous display will reappear.

This completes ribbon controller settings.

If ribbon controller settings have been made, the [RIBBON ASSIGN] indicator will always be lit. Conversely, if the [RIBBON ASSIGN] indicator is dark, no parameter changes have been assigned, and the sound will not change if you touch the ribbon controller.

5. Return the sliders/knobs to the positions in which they were set for step 1.

When the ribbon controller is operated, the various parameter values will change in the amount specified by step 3, relative to the current slider/knob positions.

This means that if you move the sliders/knobs after making settings, this will change the parameter values that are produced when you touch the center of the ribbon controller. The width of the change will not be affected.

- * When you wish to check the width of the parameter change, press [RIBBON ASSIGN] while appearing the Temporary Scope display, and then move the sliders/knobs (Ribbon Scope, p.53).

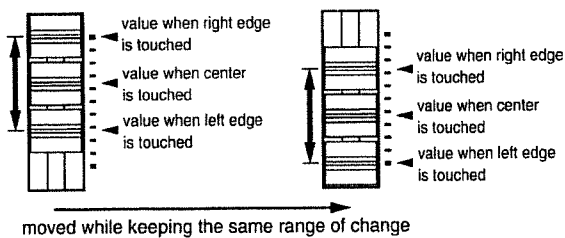

- * If the ribbon controller is used simultaneously with Velocity or Motion Control, any overlapping parameters will have their values added to produce the resulting change.

Using the Ribbon Controller to Change the Pitch

By including pitch bend in the ribbon controller settings, you can change the pitch at the same time that you modify other parameters.

The Bend Range (the width of the pitch change) is the same as the pitch bend lever's Bend Range (p.72).

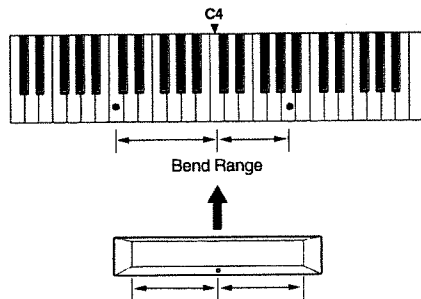

1. Press [RIBBON ASSIGN].

The indicator will blink, and the ribbon controller setting page will appear.

2. Move the Pitch Bend Lever to the right edge.

3. To end settings, press [RIBBON ASSIGN] or [EXIT].

The [RIBBON ASSIGN] indicators will change to lit, and the previous display will reappear.

Pitch settings have now been made for the ribbon controller.

Changing the Way the Sound is Controlled (Relative)

Each time you press [RELATIVE], you will switch the way in which the sound will change when you touch the ribbon controller.

When this is Off, the sound that results when you touch the center of the ribbon controller will be fixed, meaning that the sound will be different depending on where you touch the ribbon. When this is On the indicator will light, and the sound will initially remain unchanged regardless of where you touch the ribbon, and will change only when you move your finger. Thus, if you want the change to begin from the sound that you are now playing, set Relative On.



Sustaining the Change in the Sound (Hold)

Each time you press [HOLD], the Hold function will be switched on/off. When this is On the indicator will light, and the sound at the moment you take your finger off the ribbon controller will be maintained. When this is Off, the change in the sound will continue only as long as you continue pressing the ribbon controller.

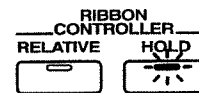

- * If you select a different Patch or Performance while still pressing the ribbon controller or while Hold is On, the changes produced by the ribbon controller will be added to the settings of the Patch, and the sound will be different than the original Patch.

Canceling the Settings of a Parameter

If you wish to cancel the settings only for a specific parameter of the parameters being controlled, use the following procedure to set the width of change to 0 for that parameter.

1. Move the slider/knob to the lowest (far left) position for the parameter whose settings you wish to cancel.

2. Press [RIBBON ASSIGN].

The indicator will blink, and the ribbon controller setting page will appear.

- Slightly raise (or rotate to the right) the slider/knob, and then return it to the lowest (far left) position.

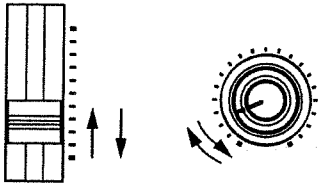

- Press [RIBBON ASSIGN] or [EXIT].

The indicator will light (or go dark if all parameters were canceled), and the previous display will reappear.

The parameter settings have now been canceled.

- Move the slider/knob to the desired position.

- * You can also set the width of change to 0 for that parameter by Ribbon Scope (p.53).

■ Canceling the bend range setting

- Press [RIBBON ASSIGN].

The indicator will blink, and the ribbon controller setting page will appear.

- Move the Pitch Bend Lever to the left edge.

- Press [RIBBON ASSIGN] or [EXIT].

The indicator will change to lit (or dark if all parameters have been canceled), and the previous display will reappear.

The bend range settings have now been erased.

Canceling the Settings of All Parameters

- Press [RIBBON ASSIGN].

The indicator will blink, and the ribbon controller setting page will appear.

- Press [WRITE].

The display will indicate "Completed."

All parameter settings have now been canceled.

- Press [RIBBON ASSIGN] or [EXIT].

The indicator will go dark, and the previous display will reappear.

Using Keyboard Dynamics to Affect Parameters (Velocity)

You can use velocity (the force (speed) at which notes are played/released) to simultaneously control multiple parameters in the same way as you can using the ribbon controller.

Velocity settings can be made independently for each Patch.

Velocity On/Off

Pressing [VELOCITY] will toggle Velocity on/off. When this is On, the indicator will light, and velocity will affect the sound as specified by your settings (see the following paragraphs). When this is Off, the sound will not change in response to your playing dynamics.



- * When Velocity is Off, sound will be produced as though the Note On velocity (the speed at which the key was pressed) and the Note Off velocity (the speed at which the key was released) were 80 (in a range of 127 steps). This also applies when note messages are received from an external MIDI device.

On the JP-8000, these are referred to as the standard velocity values.

■ Parameters which can be modified by velocity

The parameters of any sliders/knobs except for [VOLUME] and [TEMPO] can be modified by velocity.

The [R] of the Filter and Amp sections are controlled by Note-off velocity. All other parameters are controlled by Note-on velocity.

When controlling following parameters by velocity, a positive (+) setting will allow control in the positive (+) direction, and a negative (-) setting will allow control in the negative direction. It is not possible to control the parameter through the center (0) position.

- ◆ [LFO1 DEPTH] of the OSC Common section
- ◆ [ENV DEPTH] of the OSC Common section
- ◆ [LFO1 DEPTH] of the Filter section
- ◆ [ENV DEPTH] of the Filter section
- ◆ [LFO1 DEPTH/PAN] of the Amp section (except when Manual Pan)
- ◆ [DEPTH] of the LFO2 section

Velocity Settings

When you set the width of the parameter change that will occur when velocity changes from the standard value to the maximum value (127), the width of the parameter change that will occur when velocity changes from the standard value to the minimum value (0) will be set automatically.

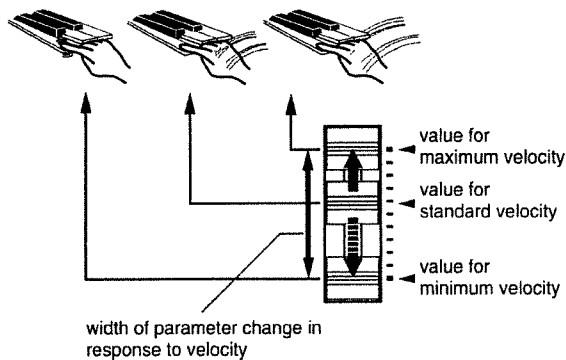

By moving the slider/knob in the opposite direction, you can also make settings that cause the parameter value to decrease as velocity increases.

1. Press [VELOCITY] to turn Velocity On.
2. Move the sliders/knobs to create the sound that will be produced by notes played with the standard velocity value.
3. Press [VELOCITY ASSIGN].

The indicator will blink, and the velocity assign page will appear.

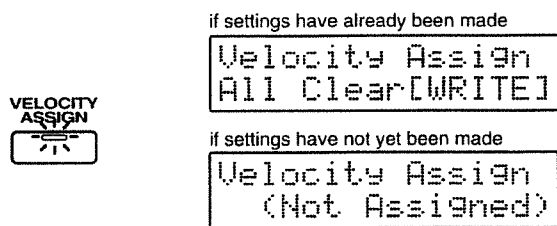

To cancel the settings, press [VELOCITY ASSIGN] or [EXIT].

4. Create the sound that will be produced by notes played with the maximum velocity.

These operations will determine the width over which the parameters will change.

5. Press [VELOCITY ASSIGN] or [EXIT].

The indicator will change to lit, and the previous display will reappear.

This completes velocity settings.

If velocity settings have been made, the [VELOCITY ASSIGN] indicator will always be lit. Conversely, if the [VELOCITY ASSIGN] indicator is dark, no parameter changes have been assigned, and the sound will not change in response to your playing dynamics even if the [VELOCITY] indicator is lit.

6. Return the sliders/knobs to the positions in which they were set for step 2.

When the keyboard is played with different velocities, the various parameter values will change in the amount specified by step 4, relative to the current slider/knob positions.

This means that if you move the sliders/knobs after making settings, this will change the parameter values that are produced when you play at the standard velocity. The width of the change will not be affected.

- * When you wish to check the width of the parameter change, press [VELOCITY ASSIGN] while appearing the Temporary Scope display, and then move the sliders/knobs (Velocity Scope, p.53).

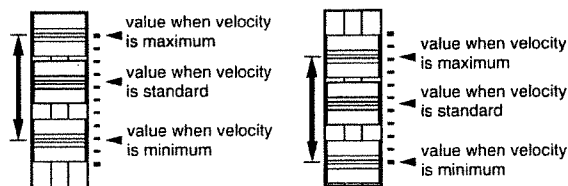

moved while keeping the same range of change

- * If velocity is used simultaneously with Ribbon controller or Motion Control, any overlapping parameters will have their values added to produce the resulting change.

● Brass instrument attacks

On brass instruments such as the trumpet, an "instability in pitch" occurs when breath is first blown into the instrument. The degree of this instability depends on the force of the breath.

By setting OSC COMMON [LFO 1 & ENV DESTINATION] to OSC 1+2, and setting OSC COMMON [PITCH ENV DEPTH] and AMP [LEVEL] for velocity, softly played notes will have little pitch change, and strongly played notes will have a large pitch change, producing a more realistic simulation of a brass instrument.

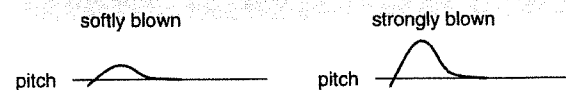

Canceling the Settings of a Parameter

If you wish to cancel the settings only for a specific parameter of the parameters being controlled, use the following procedure to set the width of change to 0 for that parameter.

1. Move the slider/knob to the lowest (or the far left) position for the parameter whose settings you wish to cancel.
2. Press [VELOCITY ASSIGN].

The indicator will blink, and the velocity setting page will appear.

3. Slightly raise (or rotate to the right) the slider/knob, and then return it to the lowest (far left) position.

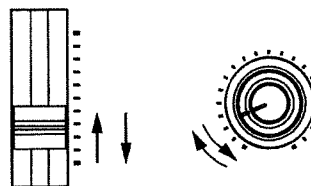

4. Press [VELOCITY ASSIGN] or [EXIT].

The indicator will light (or go dark if all parameters were canceled), and the previous display will reappear.

The parameter settings have now been canceled.

5. Move the slider/knob to the desired position.

* You can also set the width of change to 0 fir that parameter by Velocity Scope (p.53).

Canceling the Settings of All Parameters

1. Press [VELOCITY ASSIGN].

The indicator will blink, and the velocity setting page will appear.

2. Press [WRITE].

The display will indicate "Completed."

All parameter settings have now been canceled.

3. Press [VELOCITY ASSIGN] or [EXIT].

The indicator will go dark, and the previous display will reappear.

Playing Single Notes (Mono/Legato)

When using a solo instrument sound or when playing single-note solos, it is convenient to select Mono or Legato so that even if two keys are pressed simultaneously, notes will not overlap or be blurred.

Mono/Legato can be set independently for each Patch.

Mono On/Off

Pressing [MONO] will toggle Mono on/off. When this is on, the indicator will light, and single notes can be played. When this is Off, up to 8 notes can be played simultaneously.



Switching Mono/Legato

When the [MONO] indicator is lit, you can hold down [SHIFT] ([EXIT]) and press [MONO] to switch the status of the lit indicator (mono/legato). The dark status of the indicator will not change.

MONO (lit red): Notes will be articulated individually and clearly. If you combine this setting with Portamento, your playing will be smoothed.

LEGATO (lit orange): Only one note at a time will sound as same as MONO. This setting lets you play smoothly without breaks between notes only when you play legato.

About Legato

Legato generally refers to the playing technique in which two successive notes are played smoothly without a break. On the JP-8000, when you play the next key before taking your finger off the previously-played key, the new note will be played without an attack, and only the pitch will change, causing the new note to be smoothly connected.

Legato

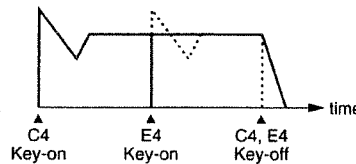

Attacks disappear and the notes are connected smoothly

Mono

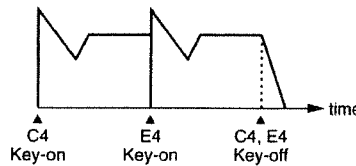

Each note has an attack

When to use Mono or Legato

It is effective to use Mono/Legato when you are playing wind instruments or analog synth sounds etc. with single-note lines, or when playing synth lead.

If Mono and Portamento are combined, the sound will always change smoothly. However if Legato is selected, two notes will be seamlessly joined only when you play legato. This allows you to use playing technique to determine whether notes will be slurred or not.

Smoothly Changing the Pitch Between Notes (Portamento)

Portamento is a function that smoothly changes the pitch from the first-played note to the pitch of the next-played note. It is effective to use Portamento when playing in Mono mode.

Portamento settings can be made independently for each Patch.

Portamento On/Off

Each time you press [PORTAMENTO], the Portamento effect will be turned on/off. When it is on the indicator will light, and the pitch of the sound will change smoothly, similarly to the way in which notes on a string instrument such as a violin can be shifted smoothly by sliding the finger which is pressing the string along the fingerboard without releasing the string. This effect is especially effective when playing sounds such as whistle or trombone.



Setting the Duration of the Pitch Change (Portamento Time)

Rotate [TIME] to set the time over which the pitch will change (Portamento Time). As the knob is rotated toward the right, the Portamento Time will become longer, and the pitch change will be slower.

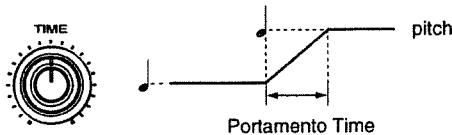

Playing in a Range Beyond the Keyboard (Oscillator Shift / Keyboard Shift)

If you wish to play notes in a range that extends higher or lower than the range of the JP-8000's keyboard, you can change the pitch produced by the keyboard in octave units. For example if you wish to play a bass sound in a range that is lower than the JP-8000's keyboard extends, you can simply press a button to shift the pitches of the keyboard downward an octave. The pitch can be changed in one-octave steps in the following two ways.

Oscillator Shift

This method changes the pitch of each Patch. It is convenient to use this method when you wish to change just the Patch of a specific Part in Dual or Split modes.

Pressing [-OCT] will lower the pitch in one-octave steps, and pressing [+OCT] will raise it in one-octave steps. Oscillator Shift can be set individually for each Patch.



- 2OCT ([-OCT] lit red) : Lower the pitch two octaves
- 1OCT ([-OCT] lit orange) : Lower the pitch one octave
- 0OCT (dark) : Normal pitch
- +1OCT ([+OCT] lit orange) : Raise the pitch one octave
- +2OCT ([+OCT] lit red) : Raise the pitch two octaves

Keyboard Shift

This method simultaneously changes the pitch of the Patches of both the Upper and Lower Part. Since the pitch of both Patches is changed simultaneously, this method is convenient when you wish to preserve the relative pitch of the two Patches, such as when using Dual mode.

Hold down [SHIFT] ([EXIT]) and press [-OCT]/[+OCT], and the Oscillator Shift buttons will change to the Keyboard Shift buttons. Keyboard Shift settings are displayed in the same way as Oscillator Shift settings, and the other button indicator will light green (refer to the diagram below).

To restore the buttons to the Oscillator Shift function, once again hold down [SHIFT] and press [-OCT]/[+OCT].

The Keyboard Shift setting is common to the entire JP-8000.

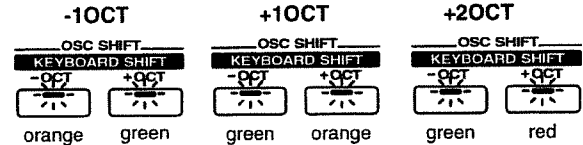

Differences between Oscillator Shift and Keyboard Shift

Oscillator Shift is a function that changes the pitch of the Patch itself. This means that, for example, if you set Oscillator Shift to +1 octave, Note messages received from MIDI IN will be played one octave higher. Conversely, Note messages transmitted from MIDI OUT will not be affected.

In contrast, Keyboard Shift changes the pitch of the keyboard. For example if you set Keyboard Shift to +1 Octave, the result is as if the keyboard were slid one octave toward the right, and notes that will sound will be one octave higher than the keys you play. In this case, Note messages that are one octave higher will be transmitted from MIDI OUT. Conversely, Note messages that are received at MIDI IN will not be played an octave higher than normal.

Transposing your Performance (Part Transpose)

Part Transpose allows you to modify the pitch that is produced when you play the keyboard, over a range of +/-2 octaves. When you need to adjust the key to other instruments or a vocal performer, you can use the Part Transpose function to change the pitch while still using the same fingering as before. This function also allows songs in a difficult key (with many sharps or flats) to be played in a simple key with easier fingering. Since Part Transpose can be set independently for each Part of a Performance, you can use it to create pitch differences between the pitch of the Parts to produce parallel harmony at a 4th or 5th interval.

* Note messages transmitted from MIDI OUT are not transposed.

Part Transpose Settings

1. Hold down [SHIFT] ([EXIT]) and press [PFM PART] ([2]).

The [PFM PART] indicator will light.

2. Press [PFM PART] to access the Part Transpose setting page.

```
Part Transpose
UPPER:          +5
```

3. Use [LOWER]/[UPPER] to select the Part whose setting you wish to change.
4. Use [DOWN]/[UP] to modify the value.
5. To end settings, press [EXIT].

The previous display will reappear.

This completes Part Transpose settings.

Changing the Pitch (Pitch Bend Lever)

When the pitch bend lever is moved to left or right, the pitch of the sounds you play will change.

Bend Range (the range of pitch change) can be set independently for each Patch.

Parts to which the Pitch Bend Lever effect will apply

The Part(s) to which the Pitch Bend Lever effect will apply will depend on the key mode.

Single, Split: The effect will apply to the Patch of the Part selected by Panel Select.

Dual: Regardless of Panel Select, the effect will apply to the Patches of both Parts. If you wish to apply the effect only to the Patch of a certain Part, set the Bend Range of that Patch to 0.

Bend Range Settings

The Bend Range is set using the keyboard. Centered on C4 (middle C), you can specify a range of up to +/-2 octaves in semitone steps.

1. Press [BEND RANGE].

The indicator will blink, and the Bend Range setting page will appear.

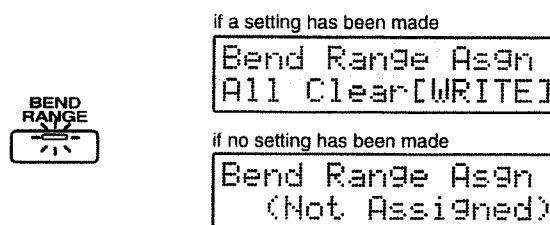

2. Press a key to the left of C4.

The range from C4 to that key will be the Bend Range available when the Pitch Bend lever is moved toward the left.

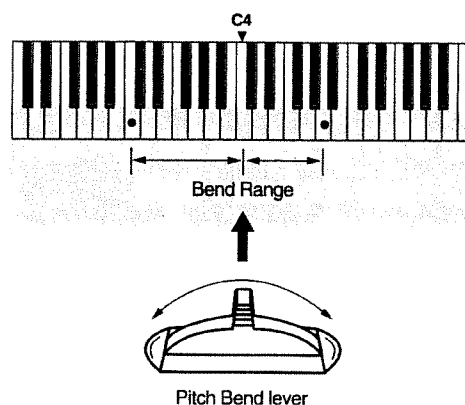

To cancel the setting, press [BEND RANGE] or [EXIT].

3. Press a key to the right of C4.

The range from C4 to that key will be the Bend Range available when the Pitch Bend lever is moved toward the right.

4. Press [BEND RANGE] or [EXIT].

The indicator will change to lit, and the previous display will reappear.

This completes Bend Range settings.

If Bend Range has been set, the [BEND RANGE] indicator will always be lit. Conversely, when the [BEND RANGE] indicator is dark, no setting has been made, and moving the Pitch Bend lever will not change the pitch.

.....

● **Guitar vibrato tailpiece simulation**

If the left Bend Range is set to the maximum (2 octaves), you will be able to produce a sudden drop in pitch similar to that produced by leaning on the vibrato arm of an electric guitar.

.....

Canceling the Bend Range Setting

1. Press [BEND RANGE].

The indicator will blink, and the Bend Range setting page will appear.

2. Press [WRITE] or press the C4 key.

The bend range settings have now been canceled.

3. Press [BEND RANGE].

The indicator will go dark, and the previous display will reappear.

■ To modify only the pitch of one side

If you wish to modify only the bend range for one side of the Pitch Bend lever, cancel the bend range settings and then re-make bend range settings just for the side that you wish to modify.

Adding Cyclic Change (Modulation Lever (LFO 2))

Chapter 3 explained how to use LFO 1 to cyclically modulate the sound, but you can also use the Modulation lever to apply modulation from LFO 2 at a different frequency than LFO 1. The LFO 2 waveform is triangle wave.

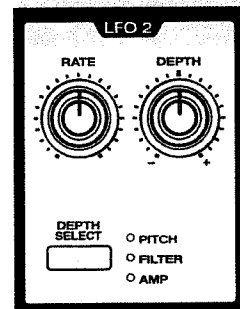

Since the sound will be affected only when you push the Modulation lever away from yourself, this is a useful way to add accents to your performance.

LFO 2 settings are made independently for each Patch.

■ Parts to which the Modulation Lever effect will apply

The Part(s) to which the Pitch Bend Lever effect will apply will depend on the key mode.

Single, Split: The effect will apply to the Patch of the Part selected by Panel Select.

Dual: Regardless of Panel Select, the effect will apply to the Patches of both Parts. If you wish to apply the effect only to the Patch of a certain Part, set the Depth of that Patch to 0.

■ Selecting the Object of Setting the Modulation Depth (Depth Select)

Press [DEPTH SELECT] to select one of the following three objects for which you will set the depth of modulation. When the Modulation lever is moved, the pitch, brightness, and volume will be modified simultaneously, each according to the Rate and the various Depth settings that you have made.

PITCH: Set the depth of the LFO 2 effect on pitch. This produces vibrato.

FILTER: Set the depth of the LFO 2 effect on the filter (brightness). This produces a wah effect.

AMP (amplifier): Set the depth of the LFO 2 effect on the amplifier (volume). This produces tremolo.

■ Setting the Modulation Depth (Depth)

Rotate [DEPTH] to set the depth of the LFO 2 effect on the currently selected Depth Select item (PITCH, FILTER, or AMP).

Rotating the knob to the right of center will produce a greater effect. Rotating the knob to the left of center will invert the LFO 2 waveform and produce a greater effect. With a setting of center, LFO 2 will not affect the sound.

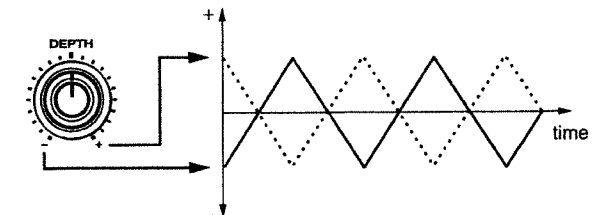

● Hints for use

By raising OSC COMMON [LFO 1 DEPTH], selecting FILTER for LFO 2 [DEPTH SELECT] and pushing the Modulation lever away from yourself, you can modify the pitch and brightness at different speeds.

.....

Setting the Modulation Speed (Rate)

Rotate [RATE] to set the speed of modulation for LFO 2. Rotating the knob toward the right will produce faster modulation.

The Rate setting is common to PITCH, FILTER, and AMP. These cannot be set separately.

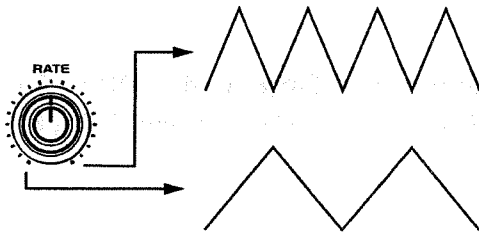

Using a Pedal to Control Your Performance (Control Pedal)

The Control Pedal allows you to adjust the volume or to control the parameters of the front panel sliders/knobs. You will need to connect an expression pedal to the Control Pedal jack.

The function of the Control Pedal can be set independently for each Performance.

OFF: No change will occur.

MODULATION: CC01: The same change will occur as when the Modulation lever is moved.

PANPOT: CC10: Pan (stereo position) will be modified.

EXPRESSION: CC11: The volume will be adjusted.

LFO1 RATE, LFO1 FADE – AMP LFO2 DEPTH, RIBBON UP, RIBBON DOWN: You can select one slider/knob from the front panel (with the exception of [VOLUME] and [TEMPO]) and use pedal operations to modify the corresponding parameter. RIBBON UP and RIBBON DOWN will produce the same changes as when the Ribbon Controller is operated (UP is from the center toward the right, and DOWN is from the center toward the left).

* CC indicates the Controller number (p.107).

Parts to which the Control Pedal effect will apply

The Part(s) to which the Control Pedal effect will apply will depend on the key mode and on the function that is selected.

Single, Split: The effect will apply to the Patch of the Part selected by Panel Select.

Dual (when MODULATION, PANPOT, EXPRESSION, RIBBON UP, or RIBBON DOWN is selected): Regardless of Panel Select, the effect will apply to the Patches of both Parts.

Dual (for other selections): The effect will apply to the Patch of the Part selected by Panel Select.

Pedal Settings

1. Hold down [SHIFT] ([EXIT]) and press [PFM COMMON] ([1]).

The [PFM COMMON] indicator will light.

2. Press [PFM COMMON] to access the Control Pedal Assign page.

```
Pedal Assign  
EXPRESSION:CC11
```

3. Use [DOWN]/[UP] to select the desired function.

To select a panel slider/knob (LFO 1 RATE-AMP LFO2 DEPTH), you can simply move the desired slider/knob and its function will be selected. To select the Ribbon Controller (RIBBON UP, RIBBON DOWN), press the right edge or the left edge of the Ribbon Controller.

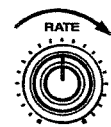

```
Pedal Assign  
LFO1 RATE
```

4. To complete the setting, press [EXIT].

The previous display will reappear.

This completes the Control Pedal function assignment.

Sustaining the Sound (Hold Pedal)

When a pedal switch is connected to the Hold Pedal jack, notes you play will be sustained as long as you press the pedal. The sound of newly-pressed keys will be layered onto currently-sounding notes. This is the same function as the damper pedal of a piano.

Parts to which the Hold Pedal effect will apply

The Part(s) to which the Hold Pedal effect will apply will depend on the key mode.

Single, Split: The effect will apply to the Patch of the Part selected by Panel Select.

Dual: Regardless of Panel Select, the effect will apply to the Patches of both Parts.

Chapter 5. Playing Arpeggios and Original Patterns (Arpeggiator / RPS)

The arpeggiator and the RPS function can be used to produce automatic playback from the keyboard.

Playing Arpeggios (Arpeggiator)

The arpeggiator (UP, DOWN, UP&DOWN, RANDOM) allows you to play arpeggios (broken chords) simply by holding a chord.

- * The data of the arpeggios will be transmitted from the MIDI OUT connector.

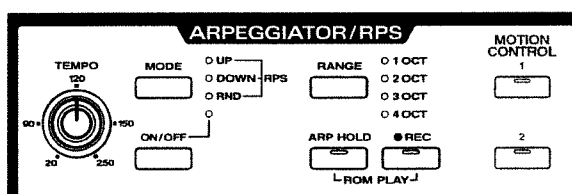

■ Parts which will be arpeggiated

The Part(s) which will be arpeggiated will depend on the key mode.

Single: The Part selected by Panel Select can be arpeggiated.

Dual: The sound of only the Upper/Lower, only the Upper, or both the Lower and Upper Parts can be layered. For details refer to "Selecting the Part for Arpeggiation in Dual Mode (Arpeggio Destination)" (p.76).

Split: Only the Lower Part will be arpeggiated. By setting Oscillator Shift to a positive (+) setting, you can cause the arpeggio to be played with notes higher than the Lower keyboard area.

Arpeggiator Settings

Arpeggiator Settings can be made independently for each Performance.

[ON/OFF]

Turn the arpeggiator/RPS on/off. When this is On the indicator will light, and the keyboard will play either arpeggios or original patterns. When this is Off the indicator will be dark, and the keyboard can be played normally.

[MODE]

Select one of the following five modes for the arpeggiator/RPS.

UP: The keys you press will sound in order of pitch beginning with the lowest.

DOWN: The keys you press will sound in order of pitch beginning with the highest.

UP&DOWN: The keys you press will sound in order of pitch, going from lowest to highest, and then back down to lowest. For this setting, both the UP and the DOWN indicators will light.

RND: The keys you press will sound in random order.

RPS: You can play original patterns simply by pressing a single key. For this setting, the UP, DOWN, and RND indicators will all be lit.

- * The Mode setting can be changed even when arpeggiator/RPS is off.

[RANGE]

Select one of the following four ranges in which the arpeggio will sound.

1 OCT : The arpeggio will sound in a one octave range (only the notes of the chord that you press).

2 OCT : The arpeggio will sound in a two-octave range.

3 OCT : The arpeggio will sound in a three-octave range.

4 OCT : The arpeggio will sound in a four-octave range.

- * When Mode is set to RPS, the Range setting has no effect.

- * The Range setting can be changed even when arpeggiator/RPS is off.

[ARP HOLD]

This switches Hold on/off for the arpeggiator/RPS. When Hold is On the indicator will light, and the arpeggio or RPS pattern will continue playing even if you take your fingers off the keys. If you play a different chord or key while the arpeggio or RPS pattern is being held, the arpeggio or pattern will change.

To stop the arpeggio or pattern, press [ARP HOLD] to turn Hold off. When Hold is off, the arpeggio or pattern will play only while you continue pressing the key(s).

- * If you have selected RPS as the Mode, you can press the C2 key (RPS STOP) to stop the patterns without turning Hold off.

[TEMPO]

This sets the tempo of the arpeggio/RPS and Motion Control (p.81). Rotating the knob toward the right will speed up the tempo.

- * It is also possible to synchronize the tempo to MIDI Clock messages transmitted by a sequencer etc. For details refer to "MIDI Sync" (p.90), and "Synchronizing the Arpeggio, Pattern, and Motion" (p.95).

Changing the Beat of the Arpeggio (Arpeggio Beat Pattern)

This setting determines the Beat Pattern of the arpeggio. The location of the accents and the note lengths of the arpeggio will change, modifying the beat (rhythm).

The Beat Pattern can be set independently for each Performance.

Beat Pattern types

1/4, 1/6, 1/8, 1/12, 1/16, 1/32, PORTA-A1-11, PORTA-B1-15, SEQUENCE-A1-7, SEQUENCE-B1-5, SEQUENCE-C1-2, SEQUENCE-D1-8, ECHO1-3, MUTE1-16, STRUMMING1-8, REFRAIN1-2, PERCUSSION1-4, WALKING BASS, HARP, RANDOM

* If you have selected RPS as the Mode, the Beat Pattern setting will have no effect.

1. Hold down [SHIFT] ([EXIT]) and press [PFM COMMON] ([1]).

The [PFM COMMON] indicator will light.

2. Press [PFM COMMON] to access the Beat Pattern setting page.

```
Arp Beat Pattern
1/4
```

3. Use [DOWN]/[UP] to set the value.
4. When you finish making settings, press [EXIT].

The previous display will reappear.

The Beat Pattern setting has now been made.

Selecting the Part for Arpeggiation in Dual Mode (Arpeggio Destination)

When the Key mode is Dual, you can select one of two ways in which the Upper or Lower Part will be arpeggiated.

The Arpeggio Destination can be set independently for each Performance.

LOWER & UPPER: Arpeggios will be played with the layered sounds of both the Upper and Lower Parts.

LOWER: Arpeggios will be played only in the Lower Part. For example, this would allow you to play chords in the Upper Part and play arpeggios in the Lower Part.

UPPER: Arpeggios will be played only in the Upper Part.

* The Arpeggio Destination setting is valid when UP, DOWN, UP&DOWN, or RANDOM is selected as the Mode. When RPS is selected, both Upper and Lower Parts will play the Pattern.

1. Hold down [SHIFT] ([EXIT]) and press [PFM COMMON] ([1]).

The [PFM COMMON] indicator will light.

2. Press [PFM COMMON] to access the Arpeggio Destination setting page.

```
Arpeggio Dest
LOWER & UPPER
```

3. Use [DOWN]/[UP] to set the value.
4. When you finish making settings, press [EXIT].

The previous display will reappear.

The Arpeggio Destination setting has now been made.

● Technique for simultaneously playing chords and arpeggios in Dual mode

If you set the Arpeggio Destination to LOWER, and simultaneously play chords and arpeggios, normally it will be possible to play chords of up to only 4 notes. However if you set Voice Assign (p.85) to 2-6, two voices will be assigned to the arpeggio (Lower) and 6 voices will be assigned to the chord (Upper), allowing you to play chords of up to 6 notes.

Playing Original Patterns with One Finger (RPS)

RPS (Realtime Phrase Sequence) is a function that lets you assign various musical patterns to each of the keys on the keyboard, and play them with just one finger. Each of the 48 keys of the keyboard with the exception of the C2 key (RPS STOP) can be assigned an original pattern that you record, and at any time you can play a desired pattern using just one finger.

* The data of the RPS Patterns will be transmitted from the MIDI OUT connector.

■ Parts which will play Patterns

The Part(s) which will play the Patterns will depend on the Key Mode.

Single: The Part selected by Panel Select will play the pattern.

Dual: The sound of both Upper and Lower parts will be layered and will play the pattern.

Split: Only the Lower Part will play the pattern.

■ Cautions when playing patterns in Split mode

When in Split mode, only the Lower keyboard area can playback patterns. This means that when playing patterns in Split mode, the patterns you wish to use must be assigned to the keys in the Lower area (“Copying a Pattern” (p.80)).

Also, when playing patterns in Split mode, you must make Voice Assign settings (p.85) so that the number of voices assigned to Lower is greater than the number of notes which occur at the same timing within the pattern. If the number of voices assigned to Lower is less than the number of notes which occur at the same timing within the pattern, the pattern cannot be played back correctly.

Setting the Timing at Which Patterns Will Switch (Pattern Trigger Quantize)

If while a certain pattern is playing back you press another key, the pattern of the later-pressed key will be selected. The Pattern Trigger Quantize setting determines the timing at which the next pattern is selected.

Pattern Trigger Quantize is common to the entire JP-8000.

OFF: Patterns will switch at the moment that a key is pressed.

BEAT: Patterns will switch at the beginning of the next beat that occurs after the key is pressed.

MEASURE: Patterns will switch at the beginning of the measure beat that occurs after the key is pressed.

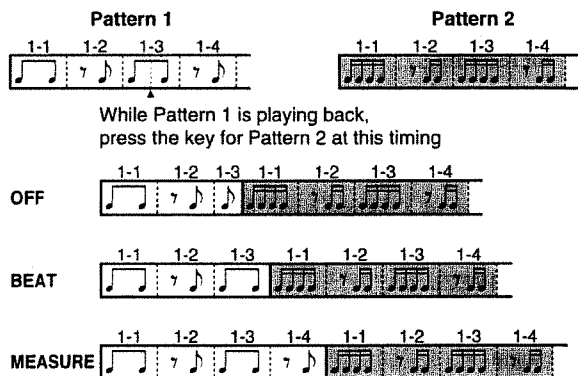

1. Hold down [SHIFT] ([EXIT]) and press [SETUP] ([6]).

The [SETUP] indicator will light.

2. Press [SETUP] to access the Pattern Trigger Quantize setting page.

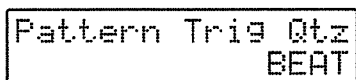

3. Use [DOWN]/[UP] to set the value.

4. When you finish making settings, press [EXIT].

The previous display will reappear.

This completes Pattern Trigger Quantize settings.

Settings for Recording

Before you record a pattern, you must set recording-related parameters during Recording Standby ([REC] blinking) or during Recording ([REC] lit). Press [LOOP LENGTH]-[METRONOME] ([1]-[4]) to select the parameter, and use [DOWN]/[UP] to set the value.

■ [LOOP LENGTH] 1-4 (measures)

Specify the number of measures in the pattern for recording/playback.

The pattern will be played/recorded repeatedly from the first measure to the number of measures that you specify.

◆ Loop Length: setting of 2 measures

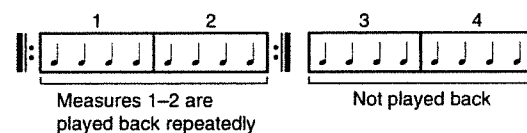

◆ Loop Length: setting of 4 measures

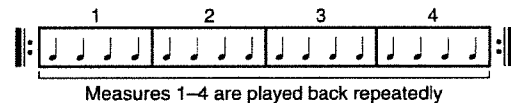

* Even if you shorten the Loop Length, the data of the measures not played back will not disappear. If you once again length the Loop Length, the original data will still be played back.

■ [QUANTIZE] (Input Quantize)

Input Quantize is a function that aligns the timing of notes played on the keyboard, moving their timing to precise intervals as they are recorded. If you use Input Quantize, your recording will be rhythmically “tight” even if the timing of your playing is slightly off.

OFF : Quantization will not be applied. Notes will be recorded at the timing that you played them.

: Notes will be aligned to the nearest 16th note triplet.

: Notes will be aligned to the nearest 16th note.

: Notes will be aligned to the nearest 8th note triplet.

: Notes will be aligned to the nearest 8th note.

: Notes will be aligned to the nearest quarter note triplet.

: Notes will be aligned to the nearest quarter note.

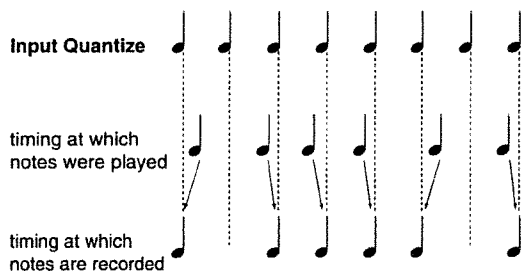

■ [GATE TIME] (Gate Time Ratio)

This sets the length of the notes being recorded, relative to the Input Quantize setting. This will cause notes to have a uniform length regardless of how they were played, and is useful when you wish to record mechanical-sounding phrases.

* If Input Quantize is turned Off, the Gate Time Ratio setting is ignored, and notes will be recorded with the length that they were played.

- REAL** : Notes will be recorded with the length that they were played.
- STACCATO** : Notes will be recorded with a short length (staccato).
- 33%** : Notes will be recorded with a length that is 33% of the Input Quantize setting.
- 50%** : Notes will be recorded with a length that is 50% of the Input Quantize setting.
- 66%** : Notes will be recorded with a length that is 66% of the Input Quantize setting.
- 100%** : Notes will be recorded with a length that is 100% of the Input Quantize setting.

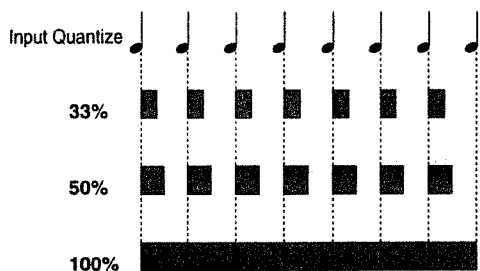

■ [METRONOME]

This selects the type of metronome sound and its volume.

Type1: VOLUME 4-1: A electronic sound (chirp) metronome will be heard.

OFF: The metronome will not sound.

Type2: VOLUME 1-4: A pulse sound (blip) metronome will be heard.

Recording a Pattern

Pattern recording will occur using a method called Loop Mix Recording, in which a pattern of a fixed length will be played back repeatedly, and new notes added to the previously-recorded notes.

* Do not turn off the power during pattern recording. Pattern or Motion data (including previously-recorded data) may be lost.

1. Press [ON/OFF] to turn on the Arpeggiator/RPS.
2. Press [MODE] to select RPS.
3. Hold down [REC], and press the key for which you wish to record a pattern.

The indicator will blink, and you will enter Recording Standby mode. The keyboard will be in normal playing condition.

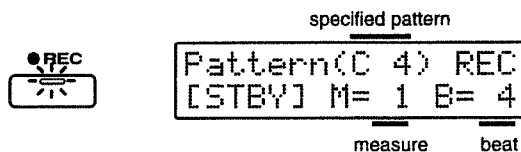

4. Press [LOOP LENGTH]-[METRONOME] ([1]-[4]) to set the recording parameters ("Settings for Recording", p.77).

After making settings, return to Recording Standby mode by pressing a button [1]-[4] whose indicator is lit or by pressing [EXIT].

5. Use [TEMPO] to specify a tempo that is comfortable for recording.

In Recording Standby mode (while [REC] is blinking), your playing on the keyboard will not be recorded. You can practice to try out the tempo.

* If you record a pattern when the Key Mode is Split, all keys will use the sound of the Lower Patch.

6. Press [REC].

The [REC] indicator will change to being lit, and recording will begin.

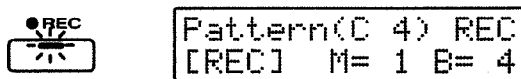

7. Listen to the metronome, and record in time with the count.

The notes you play will be successively layered.

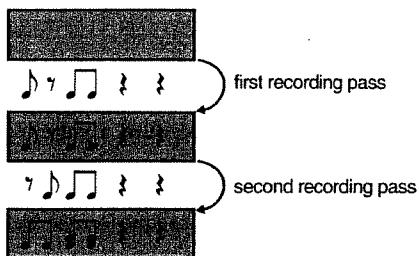

* Up to 8 notes can be recorded at the same timing.

8. During recording (while [REC] is lit) you can also modify the recording parameters.

By modifying Input Quantize and/or Gate Time Ratio setting etc., you can record notes of different length.

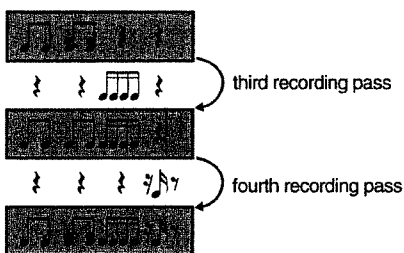

After you make settings, you can return to the recording display by pressing a button [1]-[4] whose indicator is lit or by pressing [EXIT].

9. To stop recording, press [REC] or [EXIT].

The [REC] indicator will go dark.

The pattern has now been recorded.

Erasing Unwanted Notes

During recording you can erase unwanted notes to correct your pattern. Use the keyboard to specify the note and duration that you wish to erase.

- * Do not turn off the power during the Pattern Erase operation. Pattern or Motion data (including previously-recorded data) may be lost.
- * It is not possible to erase unwanted notes during Recording Standby.

1. Enter record mode with the pattern that you wish to correct (p.78).

2. Press [ERASE] ([5]).

The following display will appear.

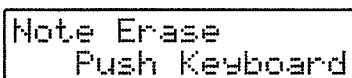

3. Erase the unwanted note(s).

If you wish to erase only a specific note, press that key. Notes of that key will be erased while you continue holding the key. If you wish to erase a specific range of notes, press the top and bottom key of that range. Notes in that range will be erased while you continue holding the key.

◆ Erasing the note(s) of just one key

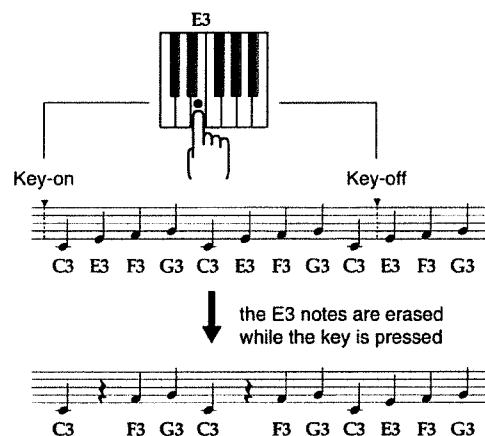

◆ Erasing the notes of a specific area

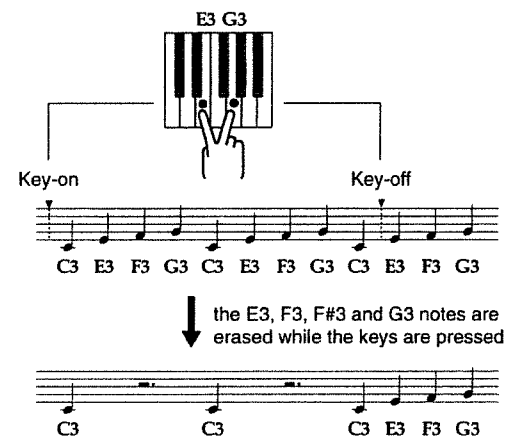

4. To resume recording, press [ERASE] or [EXIT].

You will return to recording mode.

5. To end recording, press [REC] or [EXIT].

The [REC] indicator will go dark, and recording will end.

Copying a Pattern

You can copy a pattern from one key to a different key.

* Do not turn off the power during the Pattern Copy operation. Pattern or Motion data (including previously-recorded data) may be lost.

1. Press [ON/OFF] to turn on the Arpeggiator/RPS.
2. Press [MODE] to select RPS.
3. Hold down [SHIFT] ([EXIT]) and press [INIT/UTIL] ([7]).

The [INIT/UTIL] indicator will light.

4. Press [INIT/UTIL] to access the Pattern Copy setting page.

```
Pattern Copy
FROM C 4[WRITE]
```

5. Press the key for the copy source pattern, and press [WRITE].
6. Press the copy destination key.

```
Pattern Copy
TO F#4[WRITE]
```

* Since the copied pattern will overwrite the pattern that is currently stored for the copy destination key.

To cancel the Pattern Copy operation, press [EXIT].

7. Press [WRITE].

The display will indicate "Completed".

This completes the Pattern Copy operation.

8. To end the Procedure, press [EXIT].

Erasing a Pattern

* If you perform the following procedure, a pattern you created will be cleared (erased). If you wish to keep the pattern data, either copy it to a different key or use Bulk Dump (p.97) to save the data on a sequencer etc. before erasing it.

* Do not turn off the power during the Pattern Clear operation. Pattern or Motion data (including previously-recorded data) may be lost.

1. Enter Recording Standby or recording mode for the pattern that you wish to clear (erase)(p.78).
2. Press [CLEAR] ([6]).

The following display will appear.

```
Pattern Clear
[WRITE]
```

To cancel the Pattern Clear operation without erasing the pattern, press [CLEAR] or [EXIT].

3. Press [WRITE].

The display will indicate "Completed," and then the previous display will reappear.

This completes the Pattern Clear operation.

4. To end recording, press [EXIT].

The [REC] indicator will go dark, and recording will end.

Chapter 6. Recording Slider/knob Movements (Motion Control)

The JP-8000 is able to record slider/knob movements up to 8 measures long, and play them back. By playing back the recorded slider/knob movements (Motions) in time with your music, you can add a variety of tonal changes to your playing. This function is called *Motion Control*.

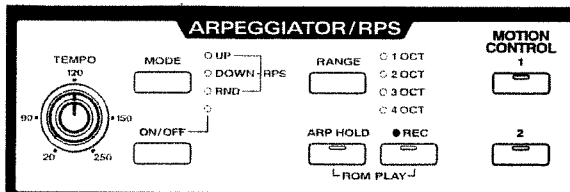

Playing Back a Motion

Motions allow you to apply complex tonal changes to arpeggio or pattern playback, or to your normal keyboard playing.

Motions will apply to the Part selected by Panel Select.

Motions can be played back in the following two ways.

■ Playing back a Motion to modify the tone while you continue playing

If you wish to playback a Motion to modify the tone while you continue to play, press [1]/[2] at the desired moment while you continue playing, and the Motion will playback. The tone will begin changing at the moment that the Motion is played back.

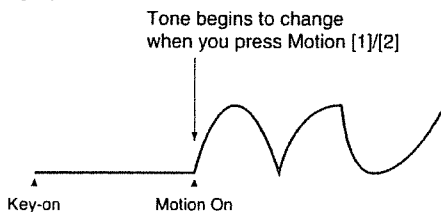

■ Playing back a Motion to modify the tone at the beginning of your playing

If you wish to playback a Motion to modify the tone from the beginning of your playing, first press [1]/[2] to start the Motion playing back, and then press a key to play the keyboard or playback a pattern. You may also make settings so that the Motion begins to playback at the moment that you press a key ("Playing Back a Motion From the Beginning Each Time a Key is Pressed (Motion Restart)," p.82).

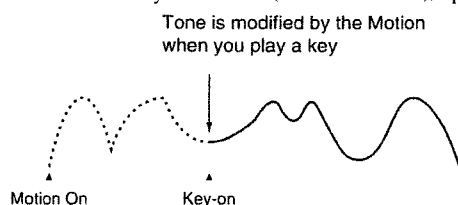

With either method, you can stop the Motion by pressing the button for the selected Motion to turn off the indicator.

When a Motion is stopped during play, the sound will not return to the original Patch settings, but will continue playing with the tone that was in effect at the end of the Motion. If you wish to bring back the original sound of the Patch, reselect the Patch.

- * The data of the Motions will be transmitted from the MIDI OUT connector.
- * If Motion Control is used simultaneously with the Ribbon Controller or Velocity, changes in the values of any overlapping parameters will be summed.

Moving Sliders or Knobs While Playing Back Motions

You can also move sliders or knobs to add further tonal changes while a Motion is playing back.

If you move a slider/knob whose movement was recorded in the Motion, the movement of the slider/knob will take priority, and the Motion-controlled tonal change will switch to the change being controlled by the slider/knob. If you then stop moving the slider/knob, the tone will again change according to the Motion when the Motion returns to the beginning.

If you move a slider/knob whose movement was not recorded in the Motion, the sound will change in the way that it normally does.

● Switching between Motions and Slider/Knob Movements

The sliders/knobs of the JP-8000 have 11 switch points. When a slider/knob is moved past one of these switch points, control over the parameter change will be transferred from the Motion to the slider/knob movement.

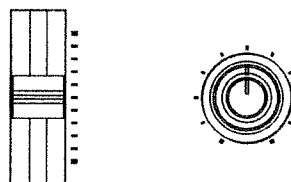

Playing Back a Motion From the Beginning Each Time a Key is Pressed (Motion Restart)

This setting lets you specify whether a Motion will be played back from the beginning each time a key is pressed.

Motion Restart can be set independently for each Performance.

OFF: The Motion will continue playing back even if you press a key again.

ON: If a key is pressed after all keys are released, the Motion will be played back from the beginning.

◆ Motion Restart OFF

Motion continues playing even if a new key is pressed

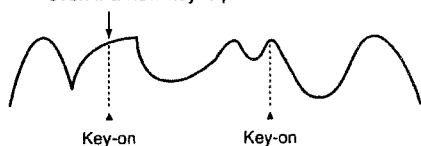

◆ Motion Restart ON

Motion plays back from the beginning when a key is pressed

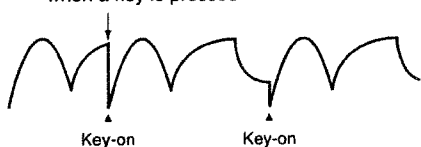

This means that when you record a Motion while playing back a Pattern, the Pattern and Motion will begin playback simultaneously when you press the key of the Pattern if Motion Restart is turned On. This is a convenient way to ensure that the start timing of the Pattern and Motion are aligned.

1. Hold down [SHIFT] ([EXIT]) and press [SETUP] ([6]).

The [SETUP] indicator will light.

2. Press [SETUP] to access the Motion Restart setting page.

```
Motion Restart
                OFF
```

3. Use [DOWN]/[UP] to set the value.
4. To complete the procedure, press [EXIT].

The previous display will reappear.

The Motion Restart setting has now been made.

Switching Motion Sets

The JP-8000 has two Motion Sets (SET A/SET B), with two motions in each set. Here you can select the Motion Set (A or B) that will be assigned to the panel buttons.

Motion Sets are common to the entire JP-8000.

1. Hold down [SHIFT] ([EXIT]) and press [SETUP] ([6]).

The [SETUP] indicator will light.

2. Press [SETUP] to access the Motion Set setting page.

```
Motion Set
                SET A
```

3. Use [DOWN]/[UP] to select the Motion Set.

4. To end the procedure, press [EXIT].

The previous display will reappear.

The Motion Set has now been selected.

Recording a Motion

Settings for Recording

Before you record a Motion, you must set recording-related parameters during Recording Standby ([REC] blinking). Press [LOOP LENGTH] or [METRONOME] ([1]–[4]) to select the parameter, and use [DOWN]/[UP] to set the value.

■ [LOOP LENGTH] 1–8 (measures)

Specify the number of measures in the Motion for recording/playback.

The Motion will be played/recorded repeatedly from the first measure to the number of measures that you specify.

◆ Loop Length: setting of 4 measures

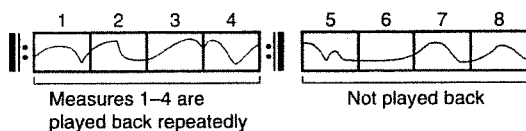

◆ Loop Length: setting of 8 measures

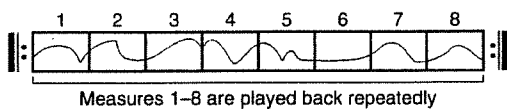

* Even if you shorten the Loop Length, the data of the measures not played back will not disappear. If you once again lengthen the Loop Length, the original data will still be played back.

■ [METRONOME]

This selects the type of metronome sound and its volume.

Type1: VOLUME 4–1: A electronic sound (chirp) metronome will be heard.

OFF: The metronome will not sound.

Type2: VOLUME 1–4: A pulse sound (blip) metronome will be heard.

Recording a Motion

Motion recording allows you to “layer” the movements of two or more knobs/sliders. Since recording will take place repeatedly over the measures that were specified by Loop Length, you can easily layer the movements of two or more knobs/sliders by operating them separately. However, moving a previously recorded knob/slider will cause the

previously recorded motion to be overwritten.

Recording will begin when you move a slider/knob, and will end automatically at the end of the last measure.

* Do not turn the power off while recording a Motion. Doing so could cause Pattern or Motion data (including previously recorded data) to be lost.

■ Parameters whose movement can be recorded in a Motion

The movement of sliders/knobs other than [VOLUME] and [TEMPO] can be recorded in a Motion.

1. Playback an arpeggio or pattern.

If you turn [ARP HOLD] on, the arpeggio or pattern will continue playing even if you release the keyboard.

If you will be recording the Motion with conventional playing, play the keyboard as desired.

2. Use [TEMPO] to set a tempo that will be comfortable for recording.

3. Hold down [REC] and press the button ([1]/[2]) to which the Motion will be recorded.

The [REC] and Motion button indicators will blink, and you will enter Recording Standby mode.

* If you turn the Motion Restart (p.82) before you record, when you record a Motion while playing back a Pattern, the Pattern and Motion will begin playback simultaneously when you press the key of the Pattern. This is a convenient way to ensure that the start timing of the Pattern and Motion are aligned.

```
Motion(A-1) REC
[STBY] M= 1 B= 4
```

4. Press [LOOP LENGTH] and [METRONOME] ([1], [4]) to set the recording parameters (“Settings for Recording”).

After making settings, return to Recording Standby by pressing the [1] or [4] button whose indicator is lit or by pressing [EXIT].

5. Recording will begin when you move a slider/knob.

If you move a slider/knob that has already been recorded, the previously recorded data will be erased as recording takes place.

Movements of other sliders/knobs will be added to the existing data.

```
Motion(A-1) REC
[REC] M= 1 B= 4
```

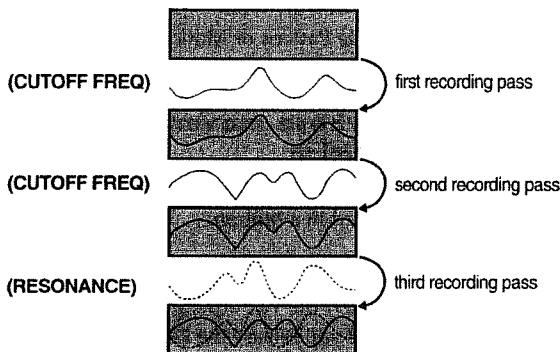

If at the end of the Motion you return the slider/knob to the same position it was in at the beginning of the Motion, the beginning and end of the Motion will be smoothly connected when the Motion is played back repeatedly.

6. To stop recording before the end of the motion, press [REC] or [EXIT].

The [REC] indicator will go dark, and recording will end.

7. If you continue recording to the end of the last measure, you will automatically exit recording and return to Recording Standby.

The [REC] indicator will change to blinking.

8. Repeat steps 5-7 to record more slider/knob movements.

9. Press [EXIT].

The indicator will go dark, and recording will end.

This completes Motion recording.

Erasing the Movement of a Slider or a Knob

A specific parameter can be erased from a Motion. Use the corresponding slider/knob to specify the parameter to be erased.

* Do not turn the power off while erasing a slider/knob movement from a Motion. Doing so could cause Pattern or Motion data (including previously recorded data) to be lost.

1. Enter recording standby for the Pattern that you wish to modify (p.83).

2. Press [ERASE] ([5]).

The following display will appear.

```
Motion Erase
Select Knob
```

3. For the parameter you wish to erase, move the corresponding slider or knob through its full range.

When the slider/knob is moved from end to end, its data will be erased.

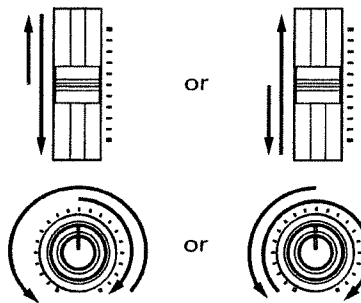

4. To resume recording, press [ERASE] or [EXIT].

You will return to Recording Standby mode.

5. To end recording, press [EXIT].

The [REC] indicator will go dark, and recording will end.

Erasing a Motion

* If you perform the following procedure, a Motion you created will be cleared (erased). If you wish to keep the Motion data, use Bulk Dump (p.97) to save the data on a sequencer etc. before erasing it.

* Do not turn off the power during the Motion Clear operation. Pattern or Motion data (including previously-recorded data) may be lost.

1. Enter Recording Standby mode for the Motion that you wish to clear (erase) (p.83).

2. Press [CLEAR] ([6]).

The following display will appear.

```
Motion Clear
[WRITE]
```

To cancel the Motion Clear operation without erasing the Motion, press [EXIT].

3. Press [WRITE].

The display will indicate "Completed," and then the previous display will reappear.

This completes the Motion Clear operation.

4. To end recording, press [EXIT].

The [REC] indicator will go dark, and recording will end.

Chapter 7. Performance/System Settings

In addition to the parameters that are edited directly by the sliders or knobs, the JP-8000 allows you to set a variety of other parameters. These parameters are assigned to [PFM COMMON]-[SETUP] ([1]-[6]) located below the display, and can be broadly categorized into Performance parameters which can be set independently for each Performance and System parameters which are common to the entire JP-8000.

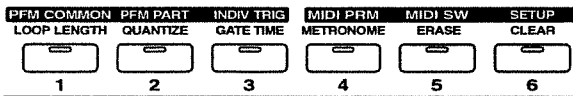

Making Performance/System Parameter settings

1. Hold down [SHIFT] ([EXIT]) and press [PFM COMMON]-[SETUP] ([1]-[6]).
The indicator of the button you pressed will light.
2. Press [PFM COMMON]-[SETUP] to select the parameter whose settings you wish to modify (refer to the sections below).
3. If you selected [PFM PART] or [EFFECTS] ([2] or [8]), press [LOWER]/ [UPPER] to select the Part whose settings you wish to modify.
4. Use [DOWN]/[UP] to modify the setting.
5. When you are finished making settings, press [EXIT].

The previous display will reappear.

Performance Parameter Functions

In addition to the Key Mode, Panel Select, and Arpeggiator/RPS settings that are set directly from the front panel, the following parameters can also be set for each Performance.

Settings for the Entire Performance (Performance Common)

[PFM COMMON]

■ Part Detune -50- +50

When the Key Mode is Dual, adjust the pitch difference between the Upper Part and Lower Part, up to a maximum of +/-50 cents (1/2 semitone). Positive (+) settings will raise the Upper pitch and lower the Lower pitch. Negative (-) settings will have the opposite effect.

● Creating a more spacious sound (2)

If you select the same Patch for both Upper and Lower and set Detune to approximately 20, the sound will appear more spacious.

■ Output Assign

This specifies how the Upper and Lower sounds will be output from the output jacks and the headphone jack.

MIX OUT: Both the Upper and Lower sounds will be output from both L and R.

PARALLEL OUT: The Lower sound will be output from L, and the Upper sound from R.

* With PARA-OUT is selected, the Auto Pan/Manual Pan (p.62) and Panning Delay (p.65) effects will not be obtained.

■ Pedal Assign OFF, MODULATION: CC01, PANPOT: CC10, EXPRESSION: CC11, LFO 1 RATE-RIBBON DOWN

This specifies the function that is assigned to the control pedal. For details refer to "Using a Pedal to Control your Performance (Control Pedal)" (p.74).

■ Voice Assign 6-2, 5-3, 4-4, 3-5, 2-6

When the Key Mode is Dual or Split, this setting specifies the number of voices that will be assigned to the Lower and Upper Parts respectively.

■ Split Point C-1-G9

When the Key Mode is Split, this setting specifies the split point. The keyboard will be divided into upper and lower areas around the specified split point.

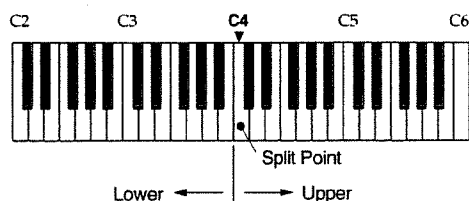

**■ Arpeggio Dest (Arpeggio Destination)
LOWER&UPPER, LOWER, UPPER**

When the Key Mode is Dual, this setting specifies whether arpeggios will be played for both the Upper and Lower Parts, or only for the Lower or Upper Part. For details refer to "Selecting the Part for Arpeggiation in Dual Mode (Arpeggio Destination)" (p.76).

■ Arp Beat Pattern (Arpeggio Beat Pattern)

1/4, 1/6, 1/8, 1/12, 1/16, 1/32, PORTA-A1-11, PORTA-B1-15, SEQUENCE-A1-7, SEQUENCE-B1-5, SEQUENCE-C1-2, SEQUENCE-D1-8, ECHO1-3, MUTE1-16, STRUMMING1-8, REFRAIN1-2, PERCUSSION1-4, WALKING BASS, HARP, RANDOM

This sets the Beat Pattern of the Arpeggio. The accent locations and note length of the arpeggio will change, modifying the beat (rhythm). For details refer to "Changing the Beat of the Arpeggio (Arpeggio Beat Pattern)" (p.76).

**Settings for Each Part
(Performance Part)**

Here you can make settings for the Part selected by Panel Select.

[PFM PART]

■ Part Transpose -24+ +24

Transpose the pitch that is sounded by the keyboard in semitone steps. For details refer to "Transposing your Performance (Part Transpose)" (p.72).

**■ Part MIDI CH (Part MIDI Channel)
1-16, OFF**

This sets the MIDI channel of the Part. Musical data from each Part will be transmitted and received on this MIDI channel. If you do not wish to use MIDI messages to select the Patch of a Part, or to transmit/receive musical data via MIDI, turn this setting OFF.

* If you set the Part MIDI channel to the same MIDI channel as the Performance Control channel (p.89), Performance selections will take priority, meaning that even when you attempt to use MIDI Program Change messages to change the Patch of the Part, the Performance will change instead. If you wish to select Patches via MIDI, select a different MIDI channel.

■ Chorus Sync

This setting lets you synchronize the Chorus Rate (p.64) to the tempo of the internal sequencer or to LFO 1.

OFF: Chorus Rate will not be synchronized to the tempo of the internal sequencer. The chorus will be applied according to the Chorus Type setting (p.64).

- ♪ (16th note) ♪ (8th note triplet)
- ♪ (dotted 16th note) ♪ (8th note)

- ♪ (quarter note triplet) ♪ (dotted 8th note)
- ♪ (quarter note) ♪ (half note triplet)
- ♪ (dotted quarter note) ♪ (half note)
- ♩ (whole note triplet) ♪ (dotted half note)
- ♩ (whole note) ♩ (double note triplet)
- ♩ (dotted whole note) ♩ (double note)

3-8 MEASURES:

Chorus Rate will be synchronized to the tempo of the internal sequencer, and the chorus will be applied at intervals of the specified note value or number of measures.

If MIDI Sync (p.90) is turned on, the Chorus Rate can be synchronized to the tempo of an external MIDI device.

LFO 1: Chorus Rate will be synchronized to the LFO 1 Rate.

● An example of using Chorus Sync

Let's try out the Chorus Sync effect.

1. Select Performance P:84.
2. Press [LOWER].
3. Play the keyboard to sound an arpeggio.
4. Move [TEMPO].

The Lower Patch will be selected.

The Chorus Rate will change in synchronization with the tempo.

■ Delay Sync

Specify whether or not the Delay Time will be synchronized to the tempo of the internal sequencer.

OFF: Delay Time will not be synchronized to the tempo of the internal sequencer. The delay will sound according to the [DELAY TIME] setting.

- ♪ (16th note) ♪ (8th note triplet)
- ♪ (dotted 16th note) ♪ (8th note)
- ♪ (quarter note triplet) ♪ (dotted 8th note)
- ♪ (quarter note) ♪ (half note triplet)
- ♪ (dotted quarter note) ♪ (half note):

Delay Time will be synchronized to the tempo of the internal sequencer, producing delayed sounds at intervals of the specified note value.

If MIDI Sync (p.90) is turned on, the Delay Time can be synchronized to an external MIDI Clock. If MIDI Sync is On but

no MIDI Clock messages are being received from an external device, delay sounds will be produced as though the sequencer tempo were set to 20.

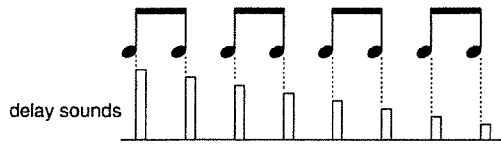

* On the JP-8000, it is not possible to make the delay time longer than 1250 ms (1.25 seconds) for a mono delay, or longer than 625 ms for a panning delay. If you attempt to set a Delay Time longer than that, the Delay Time will be halved, and the delays will sound at half the specified interval.

For tempo values slower than the following, the Delay Time will be halved.

- ♩ = 24 ♪ = 32
- ♩. = 36 ♩ = 48
- ♩ = 64 ♩. = 72
- ♩ = 96

.....

● **An example of using Delay Sync**

Let's try out the Delay Sync effect.

1. Select Performance P:84.

The Upper Patch will be selected.

2. Play the keyboard to sound an arpeggio.

3. Move [TEMPO].

The Delay Time will change in synchronization with the tempo.

If you wish to use Delay Sync as part of a sound that you create, you can do so easily by selecting the above Performance and moving the sliders or knobs to create the desired Performance.

.....

■ **LFO Sync**

This setting specifies whether or not the LFO 1 Rate will be synchronized to the tempo of the internal sequencer.

OFF: LFO 1 Rate will not be synchronized to the tempo of the internal sequencer. The sound will be modulated according to the LFO 1 section [RATE] setting.

- | | |
|--------------------------|-------------------------|
| ♩ (16th note) | ♩ (8th note triplet) |
| ♩. (dotted 16th note) | ♩ (8th note) |
| ♩ (quarter note triplet) | ♩. (dotted 8th note) |
| ♩ (quarter note) | ♩ (half note triplet) |
| ♩. (dotted quarter note) | ♩ (half note): |
| ♩ (whole note triplet) | ♩. (dotted half note) |
| ♩ (whole note) | ♩ (double note triplet) |
| ♩. (dotted whole note) | ♩ (double note) |

3-8 MEASURES:

LFO 1 Rate will be synchronized to the tempo of the internal sequencer, modulating the sound at intervals of the specified note value or number of measures.

If MIDI Sync (p.90) is turned on, the LFO 1 Rate can be synchronized to the tempo of an external MIDI device.

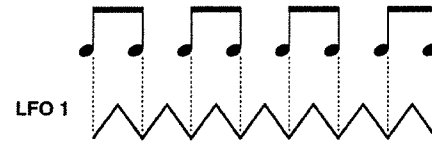

.....

● **An example of using LFO Sync**

Let's try out the LFO Sync effect.

1. Select Performance P:85.

The Upper Patch is selected.

2. Play the keyboard to sound an arpeggio.

LFO 1 will shift the panning between left and right (Auto Pan).

3. Move [TEMPO].

The LFO 1 Rate will change in synchronization with the tempo.

If you wish to create a sound using LFO Sync, an easy way to do so is to select the above Performance and then use the sliders and knobs to modify the sound to your liking.

.....

● **About Chorus/Delay/LFO Sync and MIDI Sync**

When Chorus/Delay/LFO Sync is set to a note value or measure interval, the MIDI Sync (p.90) setting will determine whether Chorus Rate, Delay Time, and LFO 1 Rate will be synchronized to the tempo specified by the JP-8000's [TEMPO] or to the tempo of an external MIDI device.

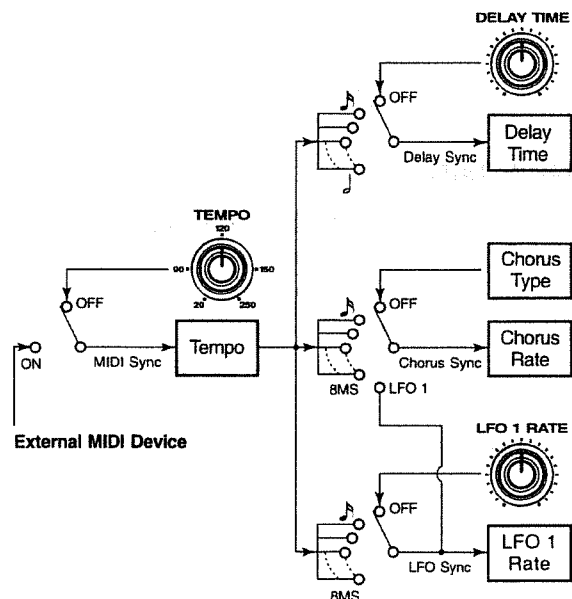

Starting an Individual Envelope While a Key Remains Pressed (Individual Trigger)

In normal playing, the pitch, filter, and amplitude envelopes will start at the moment that you play a key, causing the sound to begin changing. However on the JP-8000, you can cause just the filter or the amplitude envelope to start at a different timing than the other envelopes. This is referred to as the Individual Trigger function.

When you are playing the JP-8000 by itself and wish to use the Individual Trigger function, set Key Mode to Split. The timing of notes played in the Lower Part will start the envelope of the Upper Part.

For Single and Dual, the JP-8000's envelope will be started by note messages received from an external device.

Furthermore, the sound can be modified according to the Velocity Assign (p.68) settings by changing the velocity of the note data that is sent from the Lower Part or from an external device.

- * If the Individual Trigger switch is ON, there may be cases in which the filter envelope and/or amplitude envelope will not take effect when you play only the keyboard of the JP-8000 (the Upper Part when the Key Mode is Split), meaning that the notes may not sound as you expect. If you want the envelopes to take effect, turn the Individual Trigger switch OFF.

Example: Using the Individual Trigger function when playing the JP-8000 by itself (Key Mode: Split)

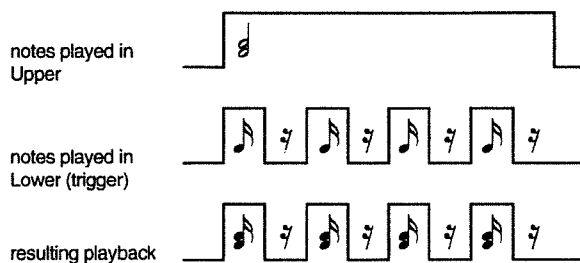

[INDIV TRIG]

■ Indv Trig Switch (Individual Trigger Switch)

This switches Individual Trigger on/off.

OFF: Note messages from the Lower Part and from an external device will be played normally.

ON: Note messages from the Lower Part and from an external device will function as envelope triggers.

■ Trig Destination (Trigger Destination)

Select the envelope that will be started by the note messages from the Lower Part and from an external device.

This effect will be more apparent if you increase the [ENV DEPTH] of the FILTER section (if FILTER is selected) or the [LEVEL] (if AMP is selected), so that the sound will be sharply articulated. (In addition, set [FREQ] to a low setting if you have selected FILTER.)

FILTER: Note messages from the Lower Part or from an external device will start the filter envelope.

AMP: Note messages from the Lower Part or from an external device will start the amplifier envelope.

FILTER& : Note messages from the Lower Part or from an external device will start the filter envelope and the amplifier envelope.

■ Trig Source CH (Trigger Source Channel) 1-16

Specify the MIDI channel on which the note messages used as triggers will be transmitted and received. Set this to a MIDI channel that is different than the Part MIDI channel (p.86).

- * If you are using note messages from the Lower Part of the JP-8000 as the trigger, note messages from the Lower Part will be transmitted on the Trigger Source Channel.

■ Trig Source Note (Trigger Source Note)

When note messages from an external device are used as the trigger, you can specify the keys of the note messages that will be treated as triggers.

- * If you are using note messages from the Lower Part of the JP-8000 as the trigger, note messages from all keys of the Lower Part will function as triggers, regardless of this Trigger Source Note setting.

C-1-G9: Note messages of the specified key will function as triggers. Note messages of other keys can be used for normal playing.

ALL: Note messages of all keys will function as triggers.

.....

● An example of using Individual Trigger

Let's try out the Individual Trigger function using the Upper Part and Lower Part of the JP-8000.

1. Select Performance P:83.
2. Press and hold any desired notes in the Upper Part.
3. Play keys in the Lower Part.

The notes of the Upper Part will sound in synchronization with the timing of the arpeggio.

If you wish to create a sound using Individual Trigger, an easy way to do so is to select the above Performance and then adjust the sliders and knobs to your liking to create the desired Performance.

.....

System Parameter Functions

These settings are common to the entire JP-8000.

* For details on MIDI, refer to "What is MIDI?" (p.107).

MIDI Settings (1) (MIDI Parameters)

[MIDI PRM]

■ Perform Ctrl CH (Performance Control Channel) 1-16, OFF

This selects the MIDI channel on which MIDI Program Change messages will be transmitted and received to select Performances. If you do not wish to select Performances via MIDI, turn this OFF.

■ Remote Ctrl CH (Remote Control Channel) 1-16, ALL, OFF

By setting the Remote Control Channel to the transmit channel of an external MIDI device, you can use the keyboard and controllers of the external MIDI device in exactly the same way as the keyboard and controllers of the JP-8000 itself. You will be able to use the external MIDI device to playback arpeggios or patterns, or record patterns or Motions.

■ Device ID (Device ID Number) 17-32

This sets the Device ID Number.

Each type of MIDI device has its own model ID number, which allows it to be distinguished from other types of device. However when MIDI data is transmitted/received between two or more identical devices, this is not enough to distinguish them, since their model IDs are the same. This is why a Device ID Number is provided so that two or more JP-8000 units can be distinguished. With the factory settings, the Device ID Number is set to 17. If you are using only a single JP-8000, there is no need to change this.

■ Tx/Rx Edit Mode (Edit Transmit/Receive Mode)

This setting determines the type of MIDI message that will be used to transmit and receive editing data when the JP-8000's sliders/knobs except for [VOLUME] and [TEMPO] are moved.

For the MIDI messages that are assigned to each slider/knob in MODE1 and for the factory setting of MODE2, refer to "Transmit/Receive Setting List" (p.116).

* If MODE2 is used to transmit and receive slider/knob movements, the communication method will fall outside of the MIDI Specification. Be aware that this mode uses MIDI in a non-standard way.

* If you want the JP-8000 to receive the MIDI message that it transmitted, the Edit Transmit/Receive Mode must be the same during both transmission and reception. If different settings are used, the MIDI messages cannot be received.

MODE1: Editing data of the sliders/knobs will be transmitted and received using the prescribed MIDI messages.

MODE2: Editing data of the sliders/knobs, you can specify the MIDI messages that will be used to transmit and receive editing data. The MIDI message that will be assigned to each controller is set by the Transmit/Receive Settings.

■ Tx/Rx Setting (Transmit/Receive Setting)

The MIDI message assigned to each slider/knob when the Edit Transmit/Receive Mode is MODE2, and the MIDI message assigned to the Ribbon Controller can be specified here. The Ribbon Controller can be assigned separate MIDI messages for the right-hand (UP) and left-hand (DOWN) areas.

While this setting page is displayed, moving a slider or knob (or in the case of the Ribbon Controller, pressing the right- or left-hand side) will cause the MIDI message assigned to that controller to appear in the display. Now you can use [DOWN]/[UP] to specify the desired MIDI message.

* While this setting page is displayed, the MIDI messages will not transmit if you move the sliders/knobs.

* The Transmit/Receive Setting of the ribbon controller is always valid, regardless of whether the Edit Transmit/Receive mode is set to MODE1 or MODE2.

* If you want the JP-8000 to receive the MIDI message of the slider/knob that it transmitted, the Transmit/Receive Setting must be the same during both transmission and reception. If different settings are used, the MIDI messages cannot be received.

The following MIDI messages can be assigned to each controller.

OFF: No MIDI message will be assigned. Moving the controller will not cause MIDI message to be transmitted.

MODULATION: CC01-CC31, CC33-PHASER:CC95, AFTERTOUCH, EXCLUSIVE: The corresponding MIDI message will be assigned.

* EXCLUSIVE cannot be assigned to the Ribbon Controller.

* CC indicate the controller number (p.107).

MIDI Settings (2) (MIDI Switch)

[MIDI SW]

■ Local Switch

This specifies whether or not the controller section will be disconnected from the internal sound source section (p.48).

* To avoid problems such as failure to sound, the Local Switch will automatically be turned ON when the JP-8000 is powered on.

OFF: The controller section will be disconnected from the sound source section. Messages from an external device will control the sound source section. However if the Edit Transmit/Receive Switch (p.90) is Off, the controller section will be able to control the sound source section.

ON: The controller section will be connected to the sound source section. The JP-8000's controllers will control the sound source.

■ **MIDI Sync**

This specifies whether or not the tempo will be synchronized to MIDI Clock messages received from an external device.

OFF: The internal sequencer will operate using the [TEMPO] setting. Any MIDI Clock messages received from an external device will be ignored.

ON: The internal sequencer will synchronize to MIDI Clock messages while receive MIDI Clock messages from an external device.

* Some external MIDI devices do not transmit MIDI Clock messages unless they are recording or playing back. If such an external MIDI device is connected, be aware that the tempo cannot be synchronized to MIDI Clock unless the external MIDI device is recording or playing back.

■ **Tx/Rx Switch (Edit Transmit/Receive Switch) OFF, ON**

This setting specifies whether MIDI messages will be transmitted/received when panel buttons, sliders and knobs are used to edit a Patch or Performance, or System settings. However if this is OFF, reception of exclusive messages will be determined by the setting of the Exclusive Receive Switch.

■ **Rx Exclusive SW (Exclusive Receive Switch) OFF, ON**

This specifies whether or not exclusive messages will be received.

■ **Tx/Rx ProgChg SW (Program Change Transmit/Receive Switch)**

This specifies how Program Change and Bank Select messages will be transmitted and received when you select sounds on an external MIDI device from the JP-8000, or when you select JP-8000 Patches or Performances from an external MIDI device.

OFF: Program Change and Bank Select messages will be neither transmitted nor received.

PC: Only Program Change messages will be transmitted and received.

BANK SEL + PC: Program Change and Bank Select messages will be transmitted and received.

Tuning / Other Settings (Setup)

[SETUP]

■ **Master Tune 427.5-452.9 (Hz)**

1cent steps for a pitch adjustment of +/- 50 cents. This is displayed as a frequency (Hz).

● **Concerning tuning**

The setting 427.5 Hz-452.9 Hz indicates the pitch of A4 (middle A). This is referred to as "standard pitch," and is the note that is normally used to indicate the pitch of an instrument. Two or more instruments can be tuned by setting their A4 pitches to match.

■ **Power Up Mode**

This specifies the state that the panel settings will be in when the power is turned on.

PERFORM P:11: The P:11 Performance will be selected.

LAST-SET: The panel will be in the state it was when the power was turned off.

■ **LCD Contrast 1-8**

This adjust the brightness of the display. Adjust it for best visibility.

■ **Pattern Trig Qtz (Pattern Trigger Quantize) OFF, BEAT, MEASURE**

This specifies the timing at which patterns will be switched. For details refer to "Setting the Timing at Which Patterns Will Switch (Pattern Trigger Quantize)" (p.77).

* When MIDI Sync is ON, Trigger Quantize can be applied to the start timing of an arpeggio or pattern.

■ **Motion Restart OFF, ON**

This specifies whether a Motion will be played back from the beginning each time a key is pressed. For details refer to "Playing Back a Motion From the Beginning Each Time a Key is Pressed (Motion Restart)" (p.82).

■ **Motion Set SET A, SET B**

This selects the Motion Set. For details refer to "Switching Motion Sets" (p.82).

Chapter 8. Restoring the Factory Settings (Initialize)

The Patch, Performance, Pattern, Motion, and System settings of the JP-8000 can be restored to the factory settings or standard settings.

* When the Initialize procedure is executed for data other than PATCH:TEMP or PERFORM:TEMP, the data for the specified type of setting will be restored to the factory values. If you have important data that you wish to keep, use the Bulk Dump operation (p.97) to save the data on an external MIDI device before you perform an Initialize operation.

Procedure

1. Hold down [SHIFT] ([EXIT]) and press [INIT/UTIL] ([7]).

The [INIT/UTIL] indicator will light.

2. Press [INIT/UTIL] to access the Initialize setting page.

```
Initialize[WRITE]
PATCH:      TEMP
```

3. Use [DOWN]/[UP] to select the type of data that will be initialized (refer to the explanations that follow).

To cancel without initializing, press [EXIT].

4. Press [WRITE].

The display will indicate "Completed," and the previous display will reappear.

This completes the Initialize operation.

Types of Initialization

PATCH: TEMP: The Temporary Patch will be set to a standard setting (p.92).

PATCH: USER ALL: All User Patches will be returned to their factory settings.

PERFORM: TEMP: The Temporary Performance will be set to a standard setting (p.92).

PERFORM: USER ALL: All User Performances will be returned to their factory settings.

PATTERN: ALL: All Patterns will be returned to their factory settings.

PATTERN: C#2-C4: The C#2-C4 Patterns will be returned to their factory settings.

PATTERN: C#4-C6: The C#4-C6 Patterns will be returned to their factory settings.

PATTERN: CURRENT: The currently selected Pattern (the Pattern of the last-pressed key) will be returned to the factory setting.

MOTION: ALL: All Motions will be returned to their factory settings.

MOTION: SET A-1: Motion A-1 will be returned to the factory setting.

MOTION: SET A-2: Motion A-2 will be returned to the factory setting.

MOTION: SET B-1: Motion B-1 will be returned to the factory setting.

MOTION: SET B-2: Motion B-2 will be returned to the factory setting.

FACTORY PRESET: All User Patches, User Performances, Patterns, Motion Control, and System settings will be returned to their factory settings.

■ Returning only a specific User Patch or User Performance to the factory setting

With the factory settings, User Patches and User Performances contain the same data as the correspondingly-numbered Preset Patches and Preset Performances. If you wish to return only a specific User Patch or User Performance to the factory setting, use the following procedure.

1. Select the Preset Patch or Preset Performance of the number corresponding to the User Patch or User Performance that you wish to return to the factory setting.
2. Save the settings to the correspondingly-numbered User Patch or User Performance.

● Standard Settings

When **PATCH : TEMP** is executed, Patch parameters will be set as follows.

When **PERFORM : TEMP** is executed, the Upper/Lower Patch parameters and Performance parameters will be set as follows.

◆ Patch parameters

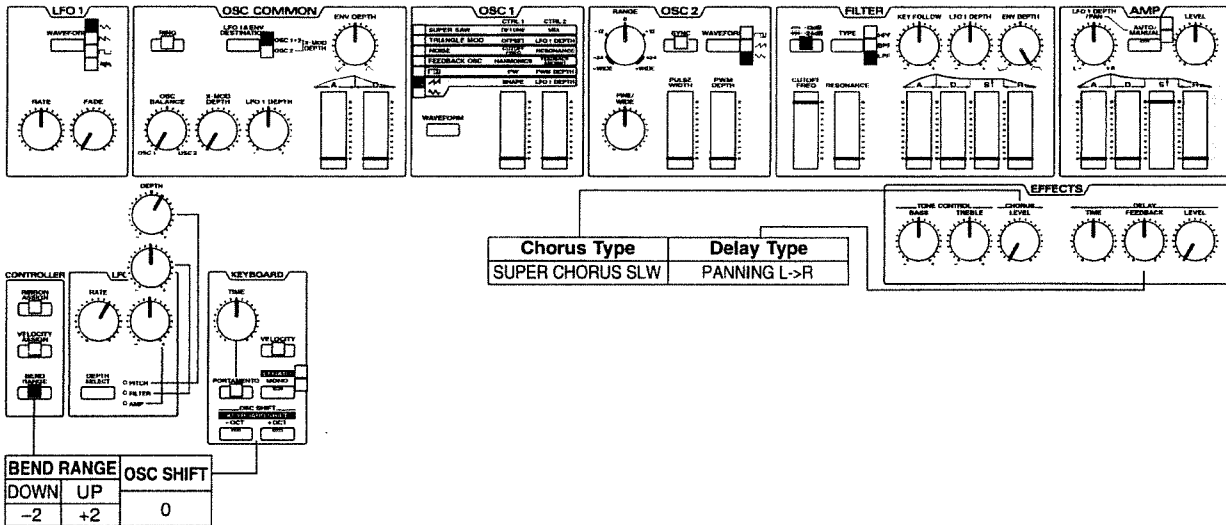

◆ Performance parameters

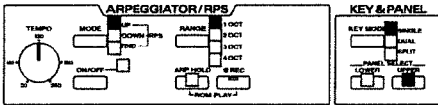

PFM COMMON ((1))		PFM PART ((2))		INDIV TRIG ((3))	
		L	U		
Part Detune	0	0	0	Indiv Trig Switch	OFF
Output Assign	MIX OUT	2	1	Trig Destination	FILTER
Pedal Assign	EXPRESSION	OFF	OFF	Trig Source CH	15
Voice Assign	4-4	OFF	OFF	Trig Source Note	ALL
Split Point	C 4	LFO Sync	OFF		
Arpeggio Dest	LOWER & UPPER				
Arp Beat Pattern	1/16				

Chapter 9. Using MIDI

Chapters 1 through 8 have explained mainly how to use the JP-8000 on its own. Now that you understand how to operate the JP-8000, let's move on to see how the JP-8000 can be connected with other MIDI devices for even more musical potential. When the JP-8000 is used by itself, a maximum of only 8 simultaneous notes can be produced, and only two Parts can be played. However by using MIDI, you can play a different sound module in the background while you play a solo on the JP-8000 or layer the sound of the JP-8000 with the sound of a different synthesizer, in this way controlling two or more MIDI devices as if they were a single instrument.

Chapter 9 will introduce several ways in which the JP-8000 can be connected with other MIDI devices.

- * For details on setting System parameters, refer to "Chapter 7. Performance/System Settings" (p.85).
- * MIDI cables are not included with the JP-8000. You will need to purchase them separately.

Controlling External MIDI Devices

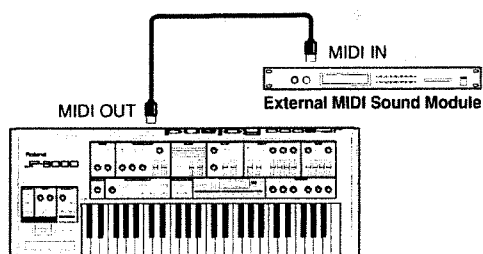

Playing External MIDI Sound Sources

Here's how you can play an external MIDI sound source from the keyboard of the JP-8000.

1. Use a MIDI cable to connect the JP-8000's MIDI OUT connector to the MIDI IN connector of the external MIDI sound source.
2. Set the MIDI channel of each JP-8000 Part to the receive channel of the sound of the external MIDI sound source that you wish to play.
[PFM PART]: Part MIDI CH
3. When you play the keyboard of the JP-8000, the notes will be sounded on the external MIDI tone source.

Selecting Sounds on an External MIDI Sound Source

When you select a Patch on the JP-8000, Program Change (p.107) and Bank Select (p.107) messages are transmitted on the Upper/Lower MIDI channels. When you select a Performance, the Program Change and Bank Select messages corresponding to the selected Performance are transmitted on the Performance Control channel.

The external MIDI sound source will receive these Program Change and Bank Select messages, and will change the sound for the corresponding MIDI channel.

- * Since the Bank Select messages that the JP-8000 is able to transmit are limited (refer to the table of the next page), for some external MIDI sound sources there will be limitations on the sounds that can be selected. For details refer to the owner's manual for your MIDI sound source.

1. Use a MIDI cable to connect the JP-8000's MIDI OUT connector to the MIDI IN connector of the external MIDI sound source.
2. If you want sounds to be selected on the external MIDI sound source when you change Patches, set the JP-8000's Part MIDI channel to match the Receive Channel of the external MIDI sound source.

[PFM PART]: Part MIDI CH

If you want sounds to be selected on the external MIDI sound source when you Performances, set the JP-8000's Performance Control Channel to match the Receive Channel of the external MIDI sound source.

[MIDI PRM]: Perform Ctrl CH

3. Set the Program Change Receive/Transmit Switch to BANK SEL + PC.

[MIDI SW]: Tx/Rx ProgChg SW

4. Select Patches or Performances on the JP-8000.

Program Change messages (or Program Change and Bank Select messages) will be transmitted, and the sound of the external MIDI sound source will change.

- * If the desired sound is not selected, set Program Change Receive/Transmit Switch to PC, and manually select the appropriate bank on the external MIDI sound source beforehand.
- * If the program numbers on the external MIDI sound source are expressed as 0-127, subtract 1 from the program number in the following table.

Patches	Bank Select (MSB/LSB)	PC#
User Patches		
A11–A88	50H/00H	1–64
B11–B88	50H/00H	65–128
Preset Patches		
A11–A88	51H/00H	1–64
B11–B88	51H/00H	65–128
Performances	MSB/LSB	PC#
User Performances		
1–64	51H/00H	1–64
Preset Performances		
1–64	51H/00H	1–64

* MSB is the value of controller number 0, and LSB is the value of controller number 32.

* PC# is the program number.

● About MIDI patchers

When several external MIDI devices are connected, the signal will gradually become degraded as the distance from the transmitting device increases, eventually producing reception errors. If you wish to connect three or more external devices, we recommend that you use a MIDI patcher (optional: A-880) and make connections as shown in the following diagram.

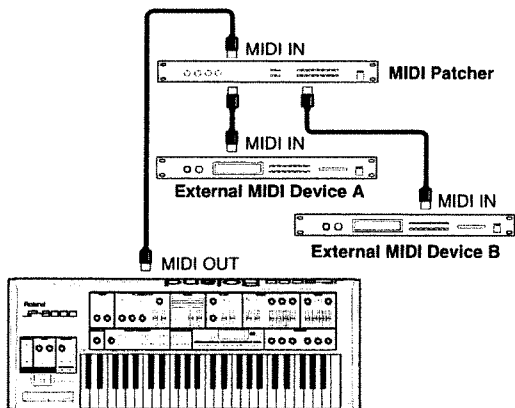

Controlling the JP-8000 from an External MIDI Device

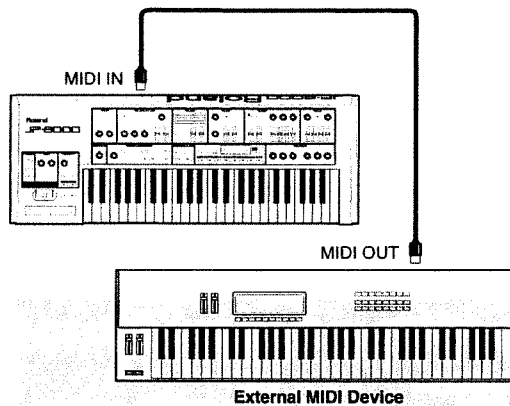

Playing the Sounds of the JP-8000

You can play the keyboard of an external MIDI device or use other musical data to play the sound source of the JP-8000.

1. Use a MIDI cable to connect the MIDI OUT connector of the external MIDI device to the JP-8000's MIDI IN connector.
2. Set the MIDI channel of each JP-8000 Part to match the transmit channels of the external MIDI device.
[PFM PART]: Part MIDI CH
3. When you play the keyboard of the external MIDI device, the JP-8000 will sound.

Selecting Patches on the JP-8000

When sounds are selected on an external MIDI device, the corresponding Program Change messages (or Program Change and Bank Select messages) will be transmitted from its MIDI OUT connector. If these Program Change and Bank Select messages are received on the Upper/Lower MIDI channels, JP-8000 Patches will be selected.

The correspondence between the Program Change and Bank Select messages that the JP-8000 receives and the Patches that will be selected is the same as described in the table in "Selecting Sounds on an External MIDI Sound Source".

1. Use a MIDI cable to connect the MIDI OUT connector of the external MIDI device to the JP-8000's MIDI IN connector.
2. Set the MIDI channel of each JP-8000 Part to match the transmit channels of the external MIDI device.
[PFM PART]: Part MIDI CH
3. Set the Program Change Transmit/Receive Switch to PC or BANK SEL + PC.
[MIDI SW]: Tx/Rx ProgChg SW

* If a Bank Select message other than those listed in the table on page 94 is received, that Bank Select message will be ignored, and Patches will be selected within the same group.

4. Select a sound on the external MIDI device.

The JP-8000 will receive the Program Change message (or the Program Change and Bank Select messages) and will change Patches.

Selecting Performances on the JP-8000

When sounds are selected on an external MIDI device, the corresponding Program Change messages (or Program Change and Bank Select messages) will be transmitted from its MIDI OUT connector. If these Program Change and Bank Select messages are received on the Performance Control MIDI channel, JP-8000 Performances will be selected.

The correspondence between the Program Change and Bank Select messages that the JP-8000 receives and the Performances that will be selected is the same as described in the table in "Selecting Sounds on an External MIDI Sound Source" (p.94).

1. Use a MIDI cable to connect the MIDI OUT connector of the external MIDI device to the JP-8000's MIDI IN connector.

2. Set the JP-8000 Performance Control MIDI channel to match the transmit channel of the external MIDI device.

[MIDI PRM]: Perform Ctrl CH

3. Set the Program Change Transmit/Receive Switch to PC or BANK SEL + PC.

[MIDI SW]: Tx/Rx ProgChg SW

* If a Bank Select message other than those listed in the table on page 94 is received, that Bank Select message will be ignored, and Performances will be selected within the same group.

4. Select a sound on the external MIDI device.

The JP-8000 will receive the Program Change message (or the Program Change and Bank Select messages) and will change Performances.

Using Note Messages from an External Device for Individual Trigger

* For details on Individual Trigger, refer to "Starting an Individual Envelope While a Key Remains Pressed (Individual Trigger)" (p.88).

1. Use a MIDI cable to connect the MIDI OUT connector of the external MIDI device to the JP-8000's MIDI IN connector.

2. Make Individual Trigger settings.

[INDIV TRIG]: Indv Trig Switch/Trig Destination/Trig Source CH/Trig Source Note

At this time, the effect will be more apparent if you adjust the envelope of the JP-8000 sound to increase the [ENV DEPTH] (if FILTER is the trigger destination) or the [LEVEL] (if AMP is the trigger destination), so that the sound will be sharply articulated. (In addition, set [CUT-OFF FREQ] to a low setting if you have selected FILTER.)

3. Set the transmit channel of the external MIDI device.

Set it to match the Trigger Source Channel of the JP-8000.

4. Press and hold notes on the JP-8000's keyboard.

5. Start the sequencer of the external MIDI device.

The JP-8000 will sound at the timing of the incoming Note messages.

Playing an arpeggio or pattern / Recording a pattern

1. Use a MIDI cable to connect the MIDI OUT connector of the external MIDI keyboard to the JP-8000's MIDI IN connector.

2. Set the JP-8000 Remote Control channel to match the transmit channel of the external MIDI keyboard.

[MIDI PRM]: Remote Ctrl CH

3. By playing the external MIDI keyboard, you will be able to play arpeggios or patterns.

4. If you enter Pattern Record mode and play the external MIDI keyboard, the pattern you play will be recorded.

Synchronizing to External MIDI Devices

Synchronizing the Arpeggio, Pattern and Motion

1. Use a MIDI cable to connect the MIDI OUT connector of the external MIDI device to the JP-8000's MIDI IN connector.

2. Turn on MIDI Sync.

[MIDI SW]: MIDI Sync

3. Make settings on the external MIDI device so that it will transmit MIDI Clock messages.

4. Start playback on the external MIDI device.

5. While listening to the playback of the external MIDI device, start a Pattern or Motion.

The Arpeggio, Pattern, or Motion will play at the same tempo as the playback of the external MIDI device. If you adjust the tempo of the external MIDI device, the tempo of the Arpeggio, Pattern, or Motion will change accordingly.

* Some external MIDI devices do not transmit MIDI Clock messages unless they are recording or playing back. If such an external MIDI device is connected, be aware that Arpeggio synchronization will not be possible unless the external MIDI device is recording or playing back.

Synchronizing Chorus, Delay and LFO 1

1. Use a MIDI cable to connect the MIDI OUT connector of the external MIDI device to the JP-8000's MIDI IN connector.
2. Make the desired settings for Chorus Sync, Delay Sync, or LFO Sync.
[PFM PART]: Chorus Sync/Delay Sync/LFO Sync
3. Turn on MIDI Sync.
4. Make settings on the external MIDI device so that it will transmit MIDI Clock messages.
5. Start playback on the external MIDI device.
6. While listening to the playback of the external MIDI device, play the JP-8000.

The delay will sound or the Chorus and the LFO 1 will change etc. at the same tempo as the playback of the external MIDI device. If you change the tempo on the external MIDI device, the Delay Time or LFO 1 Rate will change correspondingly.

- * Some external MIDI devices do not transmit MIDI Clock messages unless they are recording or playing back. If such an external MIDI device is connected, be aware that Chorus sync, Delay sync and LFO sync will not be possible unless the external MIDI device is recording or playing back.

Recording What You Play on an External Sequencer

This section explains the procedure for using the JP-8000, an external MIDI sound source, and an external sequencer to create a multi-track recording.

The JP-8000's sound source can be used to play two tracks (Parts). The other tracks will be played on the external MIDI sound source.

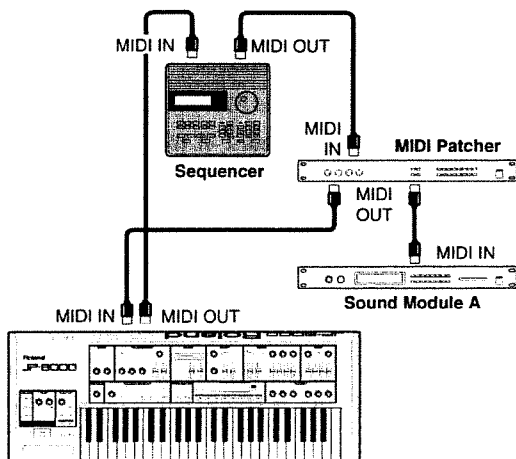

Settings for Recording

Before you begin recording, follow step 2 in "Recording Procedure" (p.97) to check the settings of each device. In order for your playing to be recorded correctly, the following parameters must be set correctly.

JP-8000 settings

■ Performance Control Channel ([MIDI PRM]: Perform Ctrl CH)

Select the MIDI channel that will be used to select Performances.

■ Part MIDI Channel ([PFM PART]: Part MIDI CH)

Select the MIDI channels of the tracks that will be played using JP-8000 Parts.

- * The receive channel of each Part on the external MIDI sound sources must be set to MIDI channels other than those selected for the JP-8000.

■ Local Switch ([MIDI SW]: Local Switch)

Turn this OFF.

When the JP-8000 is played with the connections shown in the diagram below, and the Local Switch is ON, the musical data from the external sequencer MIDI OUT and the data from the JP-8000's own controllers will be received in duplicate, causing each note to be played twice (with a very slight time lag). To prevent this, turn the Local Switch OFF to disconnected the JP-8000's controller section from its sound source section.

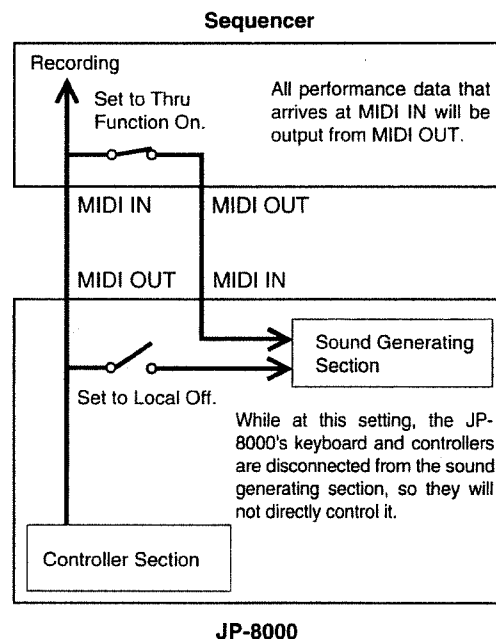

■ Edit Transmit/Receive Switch ([MIDI SW]: Tx/Rx Edit Switch)

Turn this OFF.

When you move a controller or playback a Motion, control change messages or exclusive messages will be transmitted and recorded on the external sequencer.

- * Edit Transmit/Receive Mode and Transmit/Receive Setting must be set to the same settings for playback as were used for recording. If different settings are used for recording and playback, the data will not be played back correctly.

■ Exclusive Receive Switch ([MIDI SW]: Rx Exclusive SW)

Turn this ON.

Exclusive messages recorded on the external sequencer will be received, causing various parameters to be modified.

■ Program Change Transmit/Receive Switch ([MIDI SW]: Tx/Rx ProgChg SW)

Set this to BANK SEL + PC.

When a JP-8000 Patch or Performance is selected during recording, Program Change and Bank Select messages will be transmitted and recorded on the external sequencer. The Program Changes recorded on the external sequencer will be received by the JP-8000 to select Patches and Performances.

- * The Program Change Receive Switch must also be turned ON for each Part on the external MIDI sound sources.

External Sequencer Settings

- * For the procedure of setting each function, refer to the owner's manual for your external sequencer.

■ Transmit Channel

Set the transmit channel of the tracks to be played on the JP-8000 to match the MIDI channels of the JP-8000's Parts. Set the transmit channels of the tracks to be played on external MIDI sound sources to match the receive channel of each Part on the external MIDI sound sources.

■ Thru Function

Turn this ON, so that musical data received at the MIDI IN of the external sequencer will be immediately retransmitted from its MIDI OUT.

- * If your external MIDI sequencer has no Thru function, turn ON the Local Switch of your JP-8000.

■ Tempo

Play the metronome and set a tempo that will be comfortable for recording.

Recording Procedure

1. Use MIDI cables to connect the JP-8000 and the external sequencer as shown on page 96.
2. Make settings for the JP-8000 and the external sequencer as explained in the previous section, "Settings for Recording."
3. Put the external sequencer in record mode, and record your playing.

While listening to the metronome of the external sequencer, record the rhythm parts first.

4. In the same way, record additional Parts.

For tracks to be played by the JP-8000, you can also record controller movements and Motions of the JP-8000.

- * Some sequencers are not able to record exclusive messages. If this is the case, assign other MIDI messages such as Control Changes to the controllers whose movement you wish to record ("Transmit/Receive Settings," p.89).
- * Arpeggio, Pattern, Motion, Chorus, Delay, and LFO 1 can be recorded in synchronization with the MIDI Clock of the external sequencer. For details on synchronization, refer to the explanations given in "Synchronizing to External MIDI Devices" (p.95).

Saving Settings on an External Sequencer (Bulk Dump)

The JP-8000 is able to transmit a variety of settings to an external device as exclusive messages. This function is referred to as Bulk Dump. By transmitting this data to an external sequencer that is connected to the JP-8000, you can save various JP-8000 settings. Alternatively, you can connect another JP-8000 instead of a sequencer, and set the second JP-8000 to the same settings.

Procedure

1. Use a MIDI cable to connect the JP-8000's MIDI OUT connector to the MIDI IN connector of the external sequencer.
2. Hold down [SHIFT] ([EXIT]) and press [INIT/UTIL] ([7]).
The [INIT/UTIL] indicator will light.
3. Press [INIT/UTIL] to access the Bulk Dump setting page.

```
Bulk Dump=[WRITE]
ALL
```

4. Use [DOWN]/[UP] to select the type of Bulk Dump (refer to the explanations that follow).

5. Put the external sequencer in record mode.

6. Press [WRITE] to transmit the data.

The following display will appear.

Transmitting...

To halt the Bulk Dump operation, press [EXIT].

7. When the Bulk Dump is completed, the display will indicate "Completed," and then the previous display will reappear.

8. Stop the external sequencer.

Types of Bulk Dump

* When ALL, PATCH:USER ALL, PATCH:USER A, PATCH:USER B or PERFORM:USER ALL are executed, the temporary settings will not be transmitted.

ALL: All Patches, Performances, Patterns, Motion Control, and System parameter settings will be transmitted.

PATCH: USER ALL: All User Patches will be transmitted.

PATCH: USER A: User Patches of group A will be transmitted.

PATCH: USER B: User Patches of group B will be transmitted.

PATCH: TEMP UPPER: The Patch currently selected for Upper will be transmitted.

PATCH: TEMP LOWER: The Patch currently selected for Lower will be transmitted.

PATCH: TEMP UP&LO: The Patches currently selected for Upper and Lower will be transmitted.

PERFORM: USER ALL: All User Performances will be transmitted.

PERFORM: TEMP: The currently selected Performance will be transmitted.

PATTERN: ALL: All Patterns will be transmitted.

PATTERN: C#2-C4: The C#2-C4 Patterns will be transmitted.

PATTERN: C#4-C6: The C#4-C6 Patterns will be transmitted.

PATTERN: CURRENT: The currently selected Pattern (the Pattern of the last-pressed key) will be transmitted.

MOTION: ALL: All Motions will be transmitted.

MOTION: SET A-1: Motion 1 of Motion Set A will be transmitted.

MOTION: SET A-2: Motion 2 of Motion Set A will be transmitted.

MOTION: SET B-1: Motion 1 of Motion Set B will be transmitted.

MOTION: SET B-2: Motion 2 of Motion Set B will be transmitted.

● Cautions when using bulk dump for Patterns and Motions

On the JP-8000, all Motions and Patterns share the same memory space. This means that depending on the current memory usage, a Pattern or Motion that was dumped may cause a "Memory Full!" display to appear when it is sent back to the JP-8000, and that it will not be possible to send the data back to the JP-8000. If this occurs, delete unneeded Patterns or Motions from memory, and transmit the bulk data back to the JP-8000 once again.

Restoring Saved Settings to the JP-8000

Here's how settings that were saved by bulk dump can be restored to the JP-8000.

1. Use a MIDI cable to connect the MIDI OUT connector of the external sequencer to the MIDI IN connector of the JP-8000.

2. Set the Device ID Number to the same setting as when the Bulk Dump was executed.

3. Turn the Exclusive Receive Switch ON.

[MIDI SW]: Rx Exclusive SW

4. Transmit (playback) the data from the external sequencer.

* Playback the external sequencer at the same tempo that was used when recording the bulk dump. If the playback tempo is faster, it may be impossible to restore the settings correctly.

● Hints

When recording your playing on an external sequencer, it is convenient to use Bulk Dump to record the JP-8000's PERFORM: TEMP settings at the beginning of the recording.

If this is done, the JP-8000 will automatically be given those Performance settings when the song is played back, so that you will not need to select the Performance before playback. Furthermore, even if the Performance settings are modified after the song is recorded, the playback will still use exactly the same settings.

JP-8000

Appendices

Sound-creating tips

This section will give you know-how and tips for editing a Patch to create various types of sounds. Refer to the explanations and the panel diagrams, and actually operate your JP-8000 to hear the results.

* Items for which a setting is not given in the panel diagram do not need to be set.

Bass

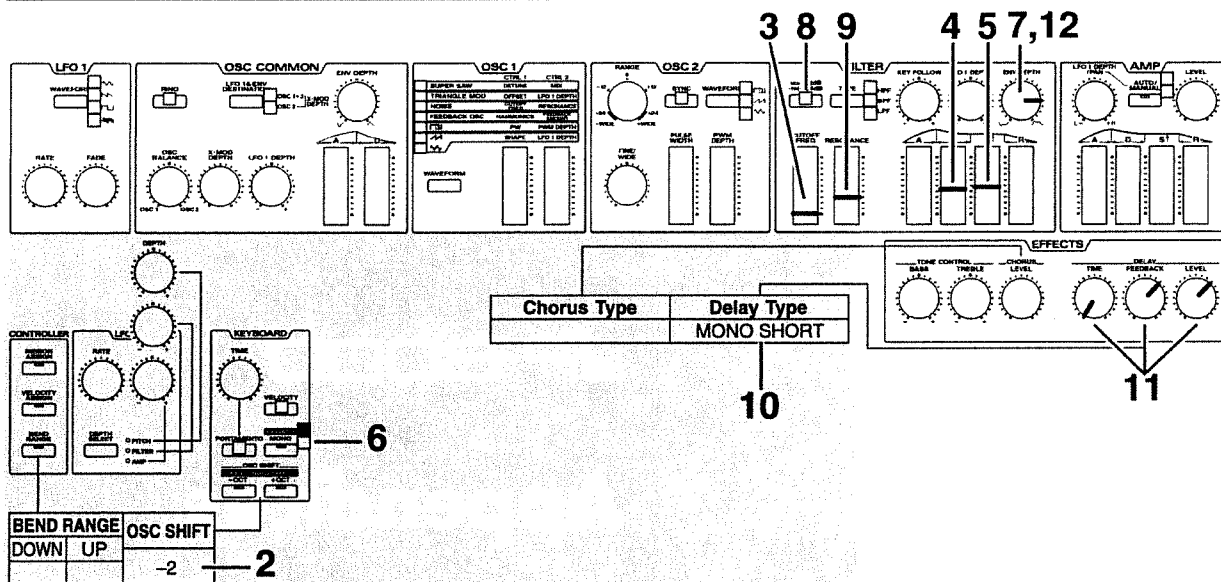

1. Use the Initialize operation to set the Performance to the basic settings.
[INIT/UTIL]: Initialize: PERFORM: TEMP
2. Since bass is a low-range instrument, set OSC SHIFT to -2 OCT.
3. Set the FILTER section [CUTOFF FREQ] to the minimum setting.
There will be no sound.
4. Move the FILTER section [D] to the position shown in the diagram to create the attack portion of the sound.
5. Move the FILTER section [S] to the position shown in the diagram to specify the tone for the sustain portion of the sound.
6. Set [MONO] to LEGATO.

With a setting of legato, you will be able to produce a legato feeling similar to that which occurs when a finger is slid to another fret without releasing the string.

7. Move the FILTER section [ENV DEPTH] to the position shown in the diagram to determine the overall tone.
The sense of attack will lessen somewhat, and the tone will become a bit darker.
8. Make the [-12dB/-24dB] indicator go dark, to select -12 dB.
The core of the sound will remain unchanged, but the tone will be less bright.
9. If desired, you can adjust the FILTER section [RESONANCE] to add a distinctive character to the tone.
10. Set the DELAY TYPE to MONO SHORT.
[EFFECTS]: Delay Type: MONO SHORT
11. Set the DELAY section [TIME] to the minimum setting, and move [FEEDBACK] and [LEVEL] to the positions shown in the diagram.
12. Adjust the FILTER section [ENV DEPTH] once again to adjust the overall tone to your taste.

Strings

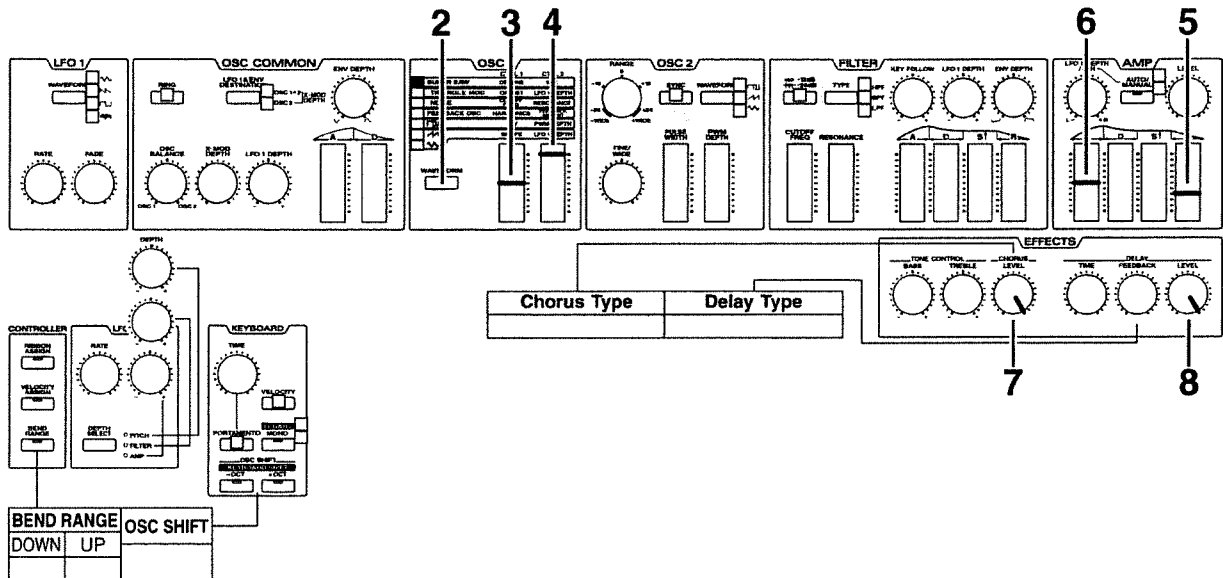

While you are creating a strings sound, it is a good idea to audition the sound by playing chords of four notes or so. This will give you a better idea of the character of the sound then if you play only an individual note.

1. Use the Initialize operation to set the Performance to the basic settings.

[INIT/UTIL]: Initialize: PERFORM: TEMP

2. For the OSC1 section [WAVEFORM], select SUPER SAW.
3. Move the OSC1 section [CTRL 1] (DETUNE) to the position shown in the diagram.
4. Move the OSC1 section [CTRL 2] (MIX) to the maximum position.

This will produce the impression of a larger ensemble of strings.

5. Move the AMP section [R] to the position shown in the diagram, so that the sound will linger for a time after the key is released.
6. Move the AMP section [A] to the position shown in the diagram, so that the attack will be a bit slower.

7. Set the CHORUS section [LEVEL] to the maximum setting.

This will give the sound greater breath and depth.

8. Set the DELAY section [LEVEL] to the maximum setting.

This will add reverberation.

Electric piano

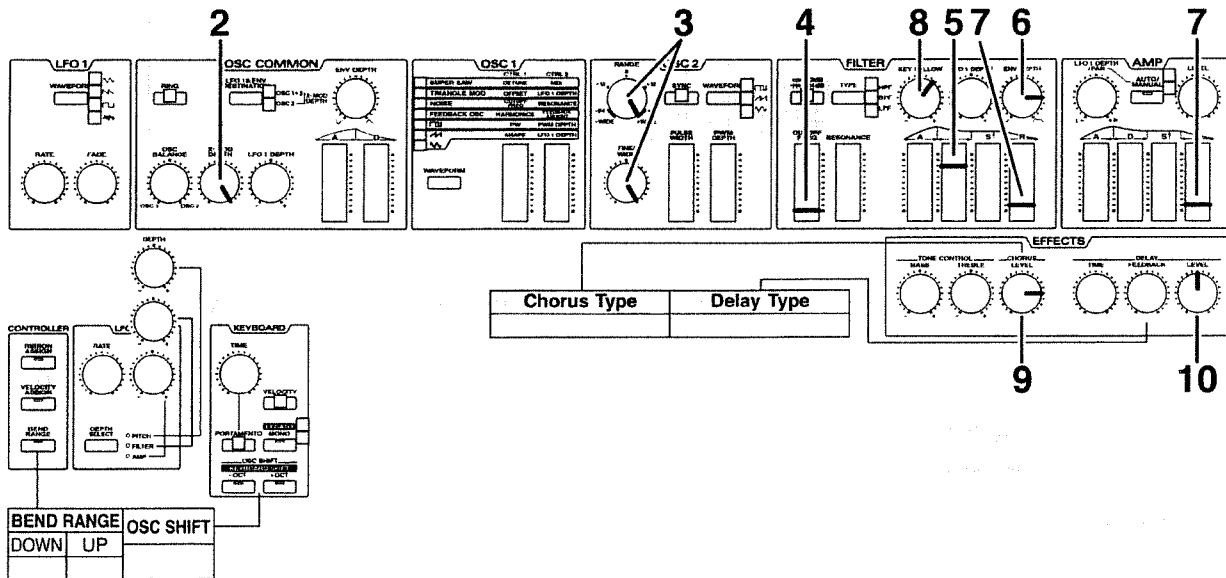

There are inevitable limitations in using conventional subtractive synthesis to attempt to simulate the sound of an electric piano, but by using X-MOD (cross modulation) you can produce the complex waveform that is required.

1. Use the Initialize operation to set the Performance to the basic settings.

[INIT/UTIL]: Initialize: PERFORM: TEMP

2. Set [X-MOD DEPTH] to the maximum setting.
3. In the OSC2 section, set [RANGE] and [FINE/WIDE] to the maximum settings.
4. Set the FILTER section [CUTOFF FREQ] to the minimum setting.
The sound will no longer be heard.
5. Move the FILTER section [D] to the position shown in the diagram, to specify how the brightness will decay.
6. Adjust the FILTER section [ENV DEPTH] to modify the tone to your taste.
7. Move the FILTER section and AMP section [R] settings to the positions shown in the diagram.

This will eliminate the click that is heard when a key is released.

8. Set the FILTER section [KEY FOLLOW] to the desired position.

Play and compare notes in the high and low keyboard ranges as you adjust this setting.

9. Move the CHORUS section [LEVEL] to the position shown in the diagram.

This will give the sound more spaciousness and depth, making it more mellow.

10. Move the DELAY section [LEVEL] to the position shown in the diagram to add reverberation to the sound.

11. If you want keyboard playing dynamics to affect the brightness (FILTER section [ENV DEPTH]) and volume (AMP section [LEVEL]), adjust the Velocity settings (p.68). Before you make these adjustments, turn on [VELOCITY] in the KEYBOARD section.

Organ

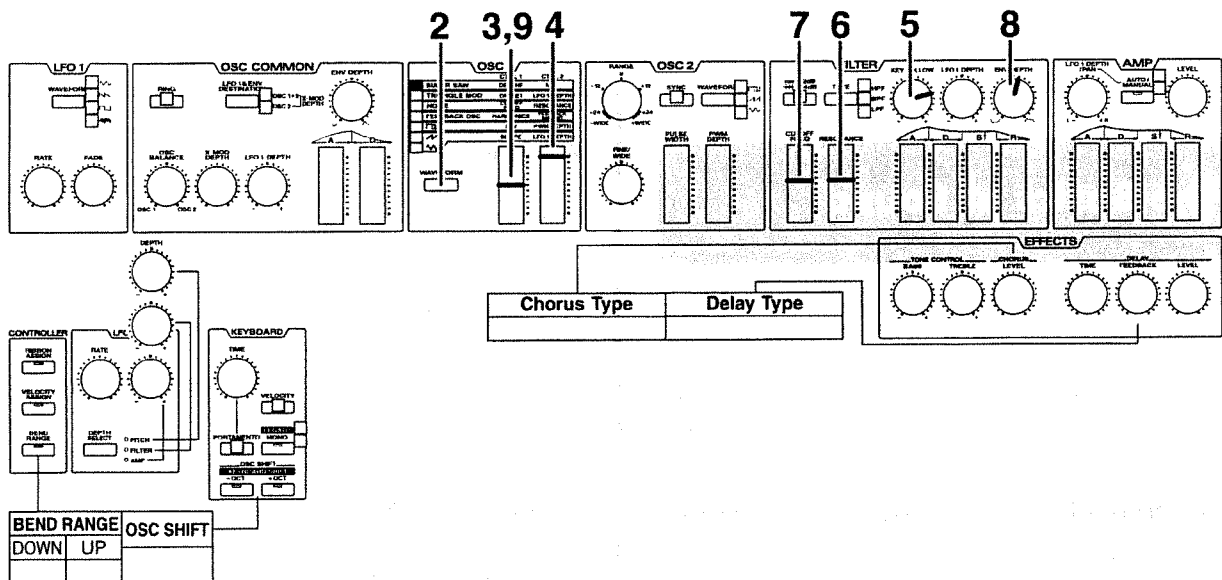

1. Use the Initialize operation to set the Performance to the basic settings.

[INIT/UTIL]: Initialize: PERFORM: TEMP

2. In the OSC1 section [WAVEFORM], select SUPER SAW.
3. Move the OSC1 section [CTRL 1] (DETUNE) to the position shown in the diagram.
4. Move the OSC1 section [CTRL 2] (MIX) to the maximum position.
5. Hold down [SHIFT] ([EXIT]) and use the FILTER section [KEY FOLLOW] and [DOWN/UP] buttons to set the Key Follow value to +32.
6. Hold down [SHIFT], and use the FILTER section [RESONANCE] and [DOWN]/[UP] to set a Resonance value in the range of 65 – 75.
7. Hold down [SHIFT] and use the FILTER section [CUTOFF FREQ] and [DOWN/UP] buttons to set the cutoff frequency value to 71.

This will use filter oscillation to add a parallel fifth harmony.

Changing the cutoff frequency value in steps of 1 will change the pitch of the oscillation in semitone steps. If you wish, you can select a different pitch as desired.

Examples) 64 → 1 octave

68 → third

75 → seventh

8. Move the FILTER section [ENV DEPTH] to the position shown in the diagram.
This will adjust the click sound which occurs when a key is released.
9. As desired, you can move the OSC1 section [CTRL 1] (DETUNE) to adjust the rotational speed of the rotary speaker.

Understanding Sound

Since moving the controllers on the JP-8000's front panel will modify the sound, it's easy to make new sounds. However if you have a certain sound in mind, moving the controllers at random will not get you any closer to the desired sound. In order to create the sound you want, you will need a basic understanding of sound. This section will provide the basic understanding of "sound" that you need. Reading and understanding it will help you create the sounds you want.

The Basics of Sound

In our lives we are surrounded by all types of sound. These sounds exist as "waves," or vibrations in the air. When these vibrations reach our ear and are conveyed to the brain, they are interpreted as "sound." The shape of these "waves" determines the type of sound that they are perceived as.

The three elements of sound •••••

The three elements of sound are "pitch," "brightness," and "volume."

■ Pitch

Pitch is determined by the speed at which the wave repeats. A wave which repeats at a frequency of once each second is referred to as a "1 Hz" (Hertz) wave.

As the frequency increases, the pitch will rise. As the frequency decreases, the pitch will be lower. For example, A4 (middle A) has a frequency of 440.0 Hz, but if this is raised an octave the frequency will be doubled (A5 = 880.0 Hz), and if it is lowered an octave the frequency will be halved (A3 = 220.00).

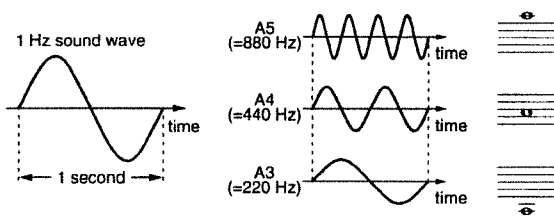

→ KEY BOARD OSC SHIFT [-OCT]/[+OCT] (p.71)

■ Brightness

Brightness is determined by the form (shape) of the wave. For example if you compare a piano waveform with a sine waveform, you will see that the piano waveform is much more complex than the sine waveform. Such differences in complexity are interpreted by our ears as the "brightness" of the sound.

Brightness is also closely related to the "partials" (over-tones) that will be discussed later.

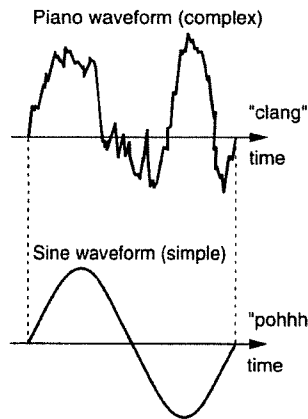

→ OSC 1 [WAVEFORM] (p.55)

→ OSC 2 [WAVEFORM] (p.57)

■ Volume

Volume is determined by the amplitude (size) of the waveform. Greater amplitude means louder volume, and lesser amplitude means softer volume.

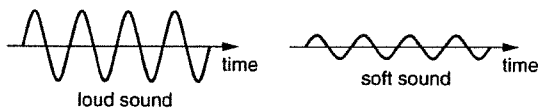

→ AMP [LEVEL] (p.62)

Partials

We have mentioned that the brightness is determined by the shape of the waveform, but how is the shape of the waveform determined?

It is generally known that waveforms are made up of multiple sine waves. For example, sawtooth waves or square waves consist of a fundamental (the "basic" frequency) plus integer multiples of the fundamental frequency such as 2x, 3x, ... and so on. These multiples of the fundamental frequency are referred to as "overtones" or "partials."

Partials which are integer multiples of the fundamental are referred to as "harmonic partials," and partials which are not integer multiples of the fundamental are referred to as "inharmonic partials." By combining these partials, an infinite range of sounds can be created.

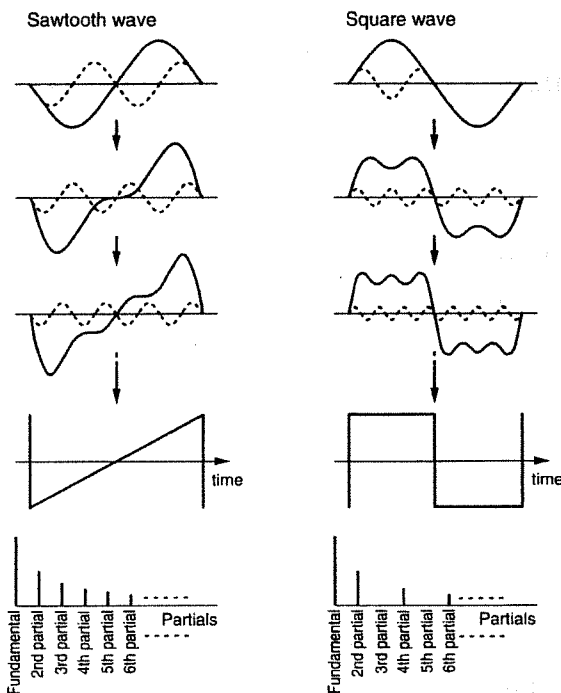

The more high-frequency partials are included in a sound, the brighter it will appear. The more low-frequency partials are included in a sound, the mellower (darker) it will appear. The technique of cutting these partials to modify the brightness (= waveform) of the sound is known as "subtractive synthesis," and is one of the most common methods of synthesis. This means that synthesizers which use this method of synthesis need to contain waveforms which include a rich assortment of partials. By using a filter to selectively cut these partials, the brightness of the sound can be modified.

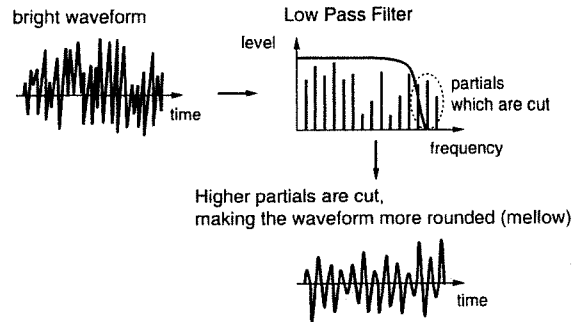

→ FILTER [TYPE] / [CUTOFF FREQ]/[RESONANCE] [-12dB/-24dB]/[KEY FOLLOW] (p.59)

In addition to the filter, the waveform can be modified by Sync, Ring Modulator, or Cross Modulation to modify the waveform in various ways.

Time-variant changes in the sound (Envelope) ...

On any acoustic instrument, the waveform goes through various changes between the beginning and the end of the note. This is because each of the three elements of sound (pitch, brightness and volume) change as time passes.

These time-variant changes are referred to as the "envelope," and every natural instrument has its own characteristic envelope.

■ Pitch envelope

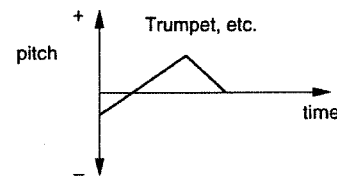

Brass instruments such as the trumpet often have a slight variance in pitch when the musician first begins to blow. On a synthesizer, this "time-variant pitch change" is created by the Pitch Envelope.

→ OSC COMMON [A]/[D] (p.59)

■ Filter envelope

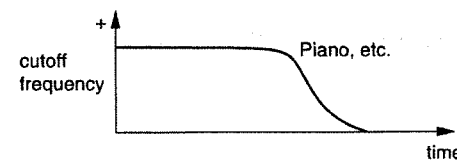

Notes on a piano etc. contain the most partials (i.e., are brightest) when the note begins, and as the sound decays, the upper partials gradually diminish, causing the tone to become more mellow (darker). On a synthesizer, this "time-variant change in brightness" is created by the Filter Envelope.

→ FILTER [A]/[D]/[S]/[R] (p.61)

■ Amplifier envelope

Piano, etc.

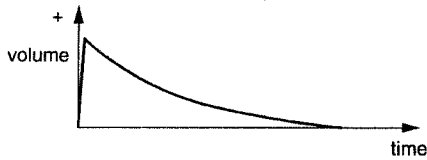

Organ, etc.

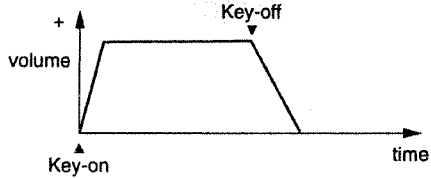

On a piano, the sound begins the instant that the key is pressed, and gradually diminishes in volume. However on an organ, the same volume is maintained as long as the key is pressed. On a synthesizer, this type of "time-variant change in volume" is created by the Amplifier Envelope.

→ AMP [A]/[D]/[S]/[R] (p.62)

Adding Expression to Sound

In addition to the "three elements of sound," there are many ways in which expression can be added. This section explains some of these ways.

Using the LFO

■ Vibrato

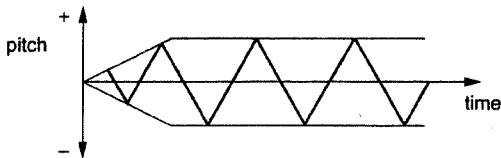

Vibrato is a cyclic modulation of the pitch. This is a performance technique often used by vocalists and on violin or flute to add expression to the sound.

→ LFO 1 [RATE] (p.63) + OSC COMMON [LFO 1 DEPTH] (p.58) etc.

■ Wah

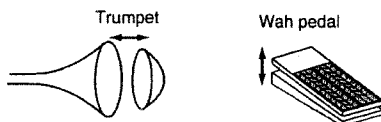
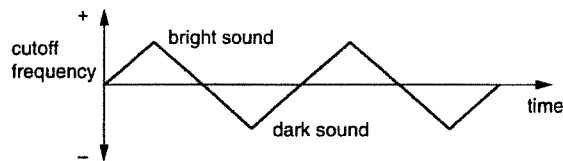

Wah is a cyclic modulation of the brightness. This is a performance technique that can be heard when a cup mute is used on a brass instrument, or when a wah pedal is used on an electric guitar.

→ LFO 1 [RATE] (p.63) + FILTER [LFO 1 DEPTH/PAN] (p.61) etc.

■ Tremolo

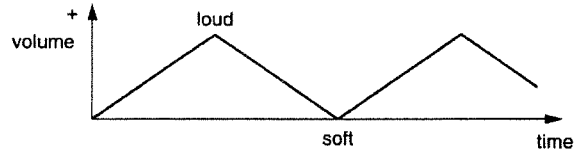

Tremolo is a cyclic modulation of the volume. This is an effect that is frequently used on electric pianos.

→ LFO 1 [RATE] (p.63) + AMP [LFO 1 DEPTH] (p.62) etc.

Effects

Effects can be categorized into two types: those which modify the overtone (partial) structure to modify the original sound itself, and those which add sound to the original sound.

■ Tone Control

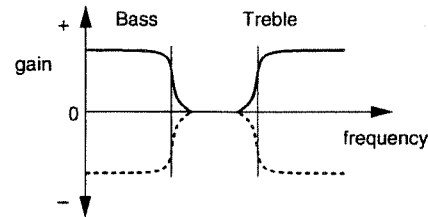

This effect adjusts the balance between the high and low frequencies by emphasizing/attenuating the high/low frequency ranges.

→ TONE CONTROL [BASS]/[TREBLE] (p.64)

■ Chorus

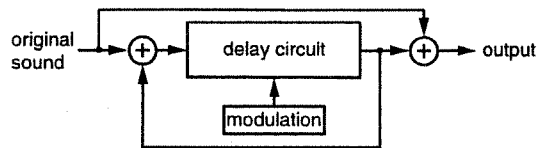

This effect adds a slightly time-delayed sound to the original sound, making the sound depth and spaciousness.

→ CHORUS [LEVEL] (p.64)

■ Delay

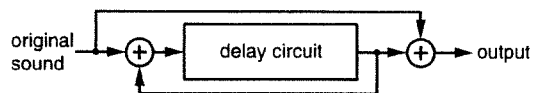

This effect adds a time-delayed sound to the original sound, creating an echo-like effect.

→ DELAY [TIME]/[FEEDBACK]/[LEVEL] (p.65)

What is MIDI?

MIDI (Musical Instrument Digital Interface) is a worldwide standard for exchanging musical data between electronic musical instruments and computers, etc. MIDI does not handle the "audio" data itself, but instead handles musical performance data and commands in digital form. The digital signals handled by MIDI are referred to as MIDI messages.

Any devices that have MIDI connectors can be connected via MIDI cables to exchange musical data, regardless of their manufacturer or model.

- MIDI IN : This connector receives MIDI messages from an external MIDI device.
- MIDI OUT : This connector transmits MIDI messages from the JP-8000.
- MIDI THRU : MIDI messages received at MIDI IN are immediately retransmitted from this connector.

MIDI Channels

MIDI is able to transmit many streams of data over a single cable. This is made possible by the concept of "MIDI channels." There are 16 MIDI channels: 1-16. MIDI messages will be received when the channels of the receiving and transmitting devices match.

On the JP-8000, the transmit channel and the receive channel are shared. If you set the MIDI channel of the Upper and Lower Parts to match the channel settings of an external MIDI device, MIDI messages can be transmitted and received on that channel.

Main MIDI Messages Used by the JP-8000

MIDI includes a wide variety of messages that can be used to convey various types of data. MIDI messages can be broadly classified into those which are handled separately by channel (Channel messages) and those which are handled regardless of channel (System messages). The main types of MIDI message used by the JP-8000 are as follows.

Channel messages •••••

These messages are used to convey musical performance operations, and make up the greater part of MIDI messages.

■ Note-on

This message is transmitted when a key is played. Each Note-on message includes the following three pieces of data, which are transmitted as one message.

- Note-on : a key was played
- Note number : the key (number) that was played
- Velocity : how strongly (quickly) it was played

Note numbers are expressed as a number in the range of 0-127, with middle C (C4) as 60.

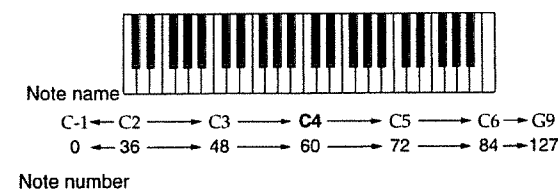

■ Note-off

This message is transmitted when a key is released. When this message is received, the sound for that key will be turned off. Each Note-off message includes the following three pieces of data, which are transmitted as one message.

- Note-off : a key was released
- Note number : the key (number) that was released
- Velocity : how strongly (quickly) it was released

■ Pitch Bend

This message indicates the position to which the pitch bend lever was moved.

■ Aftertouch

This message indicates how strongly pressure was applied to the keyboard after a note was played. There are two types of aftertouch message: Channel Aftertouch which controls an entire channel, and Polyphonic Aftertouch which controls individual notes independently. On the JP-8000 you can use the Transmit/Receive Settings (p.89) to assign aftertouch to a panel controller.

■ Program Change

This message is used to select sounds. On the JP-8000, the program numbers 1-128 of this message will select Patches or Performances (p.94).

■ Control Change

These messages are used to create musical expression. On the JP-8000, Bank Select (CC#0, CC#32) are used in conjunction with Program Change messages to select Patches or Performances (p.94). Modulation (CC#1), Pan (CC#10), Expression (CC#11), and Hold (CC#64) can be controlled via pedals or the modulation lever to add expressiveness to your playing (p.73). A variety of other control change messages can be assigned to various sliders/knobs and the Ribbon Controller by the Transmit/Receive Settings (p.89).

System Messages.....

This category includes exclusive messages, messages used for synchronization, and messages that keep a MIDI system running correctly. Of these, the JP-8000 uses mainly exclusive messages.

■ Exclusive Messages

Exclusive messages are used to convey information between devices of the same manufacturer and model (or compatible model), so that data unique to these devices (such as sound data settings) can be exchanged.

If MIDI could be used only to convey messages that were defined in the MIDI specification, it would not be possible to convey messages unique to a manufacturer or unique to a particular instrument. Thus, each manufacturer defines its own exclusive message format, and uses this format to convey proprietary data.

On the JP-8000, Transmit/Receive Settings (p.89) allow exclusive messages to be assigned to the sliders/knobs. Also, exclusive messages can be used to transmit data such as Patch settings to a sequencer for storage ("Saving Settings on an External Sequencer (Bulk Dump)" p.97).

About the MIDI Implementation Chart

MIDI handles a wide variety of performance-related messages, but the types of messages that can be transmitted or received by each type of device will differ. The MIDI Implementation Chart that is included in the owner's manual of every MIDI device tells you at a glance which types of MIDI message can be transmitted and received by that particular device. Message types marked by "O" in both charts can be exchanged between the two devices.

Troubleshooting

If there is no sound, or if the instrument does not operate the way that you expect, check the following points first. If this does not resolve the problem, contact your dealer or a nearby Roland service center.

* Roland will take no responsibility for the recovery of any settings or data, nor for any damages incurred thereby.

Power does not turn on

- **Is the Power cord connected correctly to the JP-8000 and to an AC outlet?**

Check the Power cord connections.

No sound / Volume is low

- **Is the power of the connected devices turned on?**

Make sure that the power of your amp or mixer system is turned on.

- **Is the volume turned down?**

Check the volume of the JP-8000 and of the connected amp or mixer.

- **Is there sound in the headphones?**

If there is sound in the headphones, it is possible that the connection cables are broken, or that the amp or mixer is malfunctioning. Check the connection cables and your other equipment once again.

- **Is the Demo Song playback selected?**

Simultaneously press [ARP HOLD] and [REC] in the Arpeggio/RPS section to exit Demo Song playback mode.

- **Is the Local Switch turned OFF?**

Turn the Local Switch ON (p.89).

- **Are the AMP section levels at a low setting?**

Check the [LEVEL] settings of the AMP section (p.62).

- **Is the Sustain level of the AMP section set too low?**

Check the [S] setting of the AMP section (p.62).

- **Is the frequency of the FILTER section set too low?**

Check the [CUTOFF FREQ] setting of the FILTER section (p.60).

- **Is the rate of the LFO 1 section set to slow?**

Check the [RATE] setting of the LFO 1 section (p.63).

- **Have volume messages been received from an external MIDI device to lower the volume?**

Check the volume.

- **Do the transmit channel and the receive channel match?**

Make sure that the transmit and receive channels of the JP-8000 and the external MIDI device match (p.86).

- **Is the Individual Trigger Switch turned ON?**

Turn the Individual Trigger Switch OFF (p.88).

Arpeggios or Patterns do not sound / Motion is not played back

- **If an external MIDI device is not connected**

Make sure that MIDI Sync is turned OFF (p.90).

- **If an external MIDI device is connected (and you wish to synchronize the playback)**

Turn MIDI Sync ON, and start recording or playback on the external sequencer etc. MIDI Clock messages will be transmitted, and the Arpeggio, Pattern, or Motion will begin playback (p.95).

Pitch is wrong

- **Are the Range settings of the OSC 2 section correct?**

Check the [RANGE] settings of the OSC 2 section (p.57).

- **Are the Fine tune/Wide settings of the OSC 2 section correct?**

Check the [FINE/WIDE] settings of the OSC 2 section (p.57).

● **Is the Part Transpose setting correct?**

Check the Part Transpose Setting (P.72).

● **Is the Master Tune setting correct?**

Check the Master Tune setting (p.90).

● **Has a Pitch Bend message been received from an external device, leaving the pitch "hanging"?**

Move the pitch bend lever.

Cannot select sounds

● **Is the Local Switch OFF?**

Turn the Local Switch ON (p.89).

● **Is the Program Change Transmit/Receive Switch OFF?**

Turn the Program Change Transmit/Receive Switch ON (p.90).

Notes drop out (are broken off)

● **Is Mono/Legato selected?**

When Mono or Legato is selected, only one note at a time will sound even if two or more keys are pressed. If you wish to play two or more notes at a time, press [MONO] to make the indicator go dark, selecting Poly.

● **Is the maximum simultaneous polyphony being exceeded?**

The JP-8000 can produce up to 8 notes at once. No more notes than this can be sounded at once.

Sound is cracked (distorted)

● **Is the level of the AMP section set to high?**

Check the [LEVEL] setting of the AMP section (p.62).

Click is heard when key is pressed / released

For some sounds, a click or "blip" noise may be heard when a key is pressed or released. (This will be noticeable for some sounds but not for others.) This is due to extremely fast Attack Time or Release Time settings for the filter/amplifier, and is useful for creating the click sound of an organ attack.

If you want to avoid the click sound, raise the Attack Time and Release Time settings of the filter section and amplifier section, and lower the Envelope Depth of the filter section.

MIDI messages are not transmitted / received correctly

● **Are the various MIDI channel settings correct?**

Check the Part MIDI channel and Performance Control channel settings (p.86, p.89).

● **Are the various transmit/receive switch settings correct?**

Check the settings of the Program Change Transmit/Receive Switch (p.90) and the Exclusive Receive Switch (p.90).

● **Is the Device ID Number setting correct?**

Set the Device ID Number that was used when recording the exclusive data to the sequencer (p.89).

● **Is the Bulk Dump setting (type) correct?**

Check the Bulk Dump setting (p.98).

● **Is the sequencer being played back at a correct tempo?**

Playback the sequencer at the tempo that was used when recording the exclusive data (p.98).

Error Messages

If an incorrect operation is performed or if the operation cannot be executed correctly, an error message will be displayed. Refer to the explanations below and take the appropriate action.

Battery Low!

Cause: The internal backup battery (the battery which maintains the data in the user memory) is running down.

Action: Contact your dealer or a nearby Roland service center to have the battery replaced.

Check Sum Error!

Cause: The check sum value of the received exclusive message was incorrect.

Action: Correct the check sum value.

Memory Damaged!

Cause: The data in user memory has been damaged.

Action: Contact your dealer or a nearby Roland service center to repair.

Memory Full!

Cause: User memory is full, and further recording or editing is not possible.

Action: Delete unneeded data.

MIDI Buff. Full!

Cause: More MIDI data was received at once than could be handled by the JP-8000.

Action: Reduce the amount of MIDI data that is being received by the JP-8000.

MIDI Off Line!

Cause: There is a problem with the MIDI cable connection.

Action: Check that the MIDI cable has not been disconnected or broken.

Rx Data Error!

Cause: MIDI messages could not be received correctly.

Action: If this error message appears repeatedly, there is a problem with the content of the MIDI messages.

Parameter List

Patch Parameters

Parameter		Full Name of Parameter	Value	
NAME		Patch Name	ASCII Characters (max.16)	
LFO1 Section	WAVEFORM	LFO1 Waveform	TRI, SAW, SQR, S/H	
	RATE	LFO1 Rate	0-127	
	FADE	LFO1 Fade	0-127	
OSC COMMON Section	OSC BALANCE	Oscillator Balance	-64(OSC1) - +63(OSC2)	
	RING	Ring Modulator Switch	OFF, ON	
	X-MOD DEPTH	Cross Modulation Depth	0-127	
	LFO1&ENV DESTINATION	LFO1 & Envelope Destination	OSC1+2, OSC2, X-MOD DEPTH	
	LFO1 DEPTH	Oscillator LFO1 Depth	-64- +63	
	ENV DEPTH	Oscillator Envelope Depth	-64- +63	
	A D	Oscillator Envelope Attack Time Oscillator Envelope Decay Time	0-127 0 -127	
OSC1 Section	WAVEFORM	OSC1 Waveform	SUPER SAW, TRIANGLE MOD, NOISE, FEEDBACK OSC, SQR(PWM), SAW, TRI	
	CTRL1	OSC1 Control 1	0-127	
	CTRL2	OSC1 Control 2	0-127	
OSC2 Section	WAVEFORM	OSC2 Waveform	SQR(PWM), SAW, TRI	
	SYNC	Sync Switch	OFF, ON	
	RANGE	OSC2 Range	-WIDE, -24- +24, +WIDE	
	FINE/WIDE	OSC2 Fine Tune/Wide	-50- +50cent/-4-0oct/0- +4oct	
	PULSE WIDTH	OSC2 Pulse Width	0-127	
	PWM DEPTH	OSC2 PWM Depth	0-127	
FILTER Section	TYPE	Filter Type	HPF, BPF, LPF	
	-12dB/-24dB	Cutoff Slope	-12dB/oct, -24dB/oct	
	CUTOFF FREQ	Cutoff Frequency	0-127	
	RESONANCE	Resonance	0-127	
	KEY FOLLOW	Cutoff Frequency Key Follow	-64- +63	
	LFO1 DEPTH	Filter LFO1 Depth	-64- +63	
	ENV DEPTH	Filter Envelope Depth	-64- +63	
	A D S R	Filter Envelope Attack Time Filter Envelope Decay Time Filter Envelope Sustain Level Filter Envelope Release Time	0-127 0-127 0-127 0-127	
	AMP Section	LEVEL	Amplifier Level	0-127
		AUTO/MANUAL	Auto Pan/Manual Pan Switch	OFF, AUTO PAN, MANUAL PAN
LFO1 DEPTH/PAN		Amplifier LFO1 Depth	-64(L)+63(R)	
A D S R		Amplifier Envelope Attack Time Amplifier Envelope Decay Time Amplifier Envelope Sustain Level Amplifier Envelope Release Time	0-127 0-127 0-127 0-127	
TONE CONTROL Section		BASS	Tone Control Bass	-64- +63
		TREBLE	Tone Control Treble	-64- +63
		CHORUS Section	LEVEL	Chorus Level
DELAY Section	TIME	Delay Time	0-127	
	FEEDBACK	Delay Feedback	0-127	
	LEVEL	Delay Level	0-127	
KEYBOARD Section	VELOCITY	Velocity Switch	OFF, ON	
	PORTAMENTO	Portamento Switch	OFF, ON	
	TIME	Portamento Time	0-127	

	MONO	Mono Switch	OFF, ON
	LEGATO	Legato Switch	OFF, ON
	OSC SHIFT	Oscillator Shift	-2OCT- +2OCT
LFO2 Section	RATE	LFO2 Rate	0-127
	DEPTH SELECT	Depth Select	PITCH, FILTER, AMP
	DEPTH (PITCH)	Pitch LFO2 Depth	-64- +63
	DEPTH (FILTER)	Filter LFO2 Depth	-64- +63
	DEPTH (AMP)	Amp LFO2 Depth	-64- +63
CONTROLLER Section	RIBBON ASSIGN	Ribbon Assign	-127- +127/-100 - +100/-50 - +50
	VELOCITY ASSIGN	Velocity Assign	-127 - +127/-100 - +100/-50 - +50
	BEND RANGE (UP)	Bend Range Up	0-24 semitone
	BEND RANGE (DOWN)	Bend Range Down	0-24 semitone
[EFFECT] ((8))	Chorus Type	Chorus Type	SUPER CHORUS SLW/MID/ FST/CLR, FLANGER SLOW/ DEEP/FAST, DEEP PHASING SLW, JET PHASING, TWISTING, FREEZE PHASE 1/2
	Delay Type	Delay Type	PANNING L->R/R->L/SHORT, MONO SHORT/LONG

Performance Common Parameters

Parameter		Name of Parameter	Value
NAME		Performance Name	ASCII Characters (max,16)
KEY & PANEL Section	KEY MODE	Key Mode	SINGLE, DUAL, SPLIT
	PANEL SELECT	Panel Select	LOWER & UPPER, LOWER, UPPER
ARPEGGIATOR/RPS Section	ON/OFF	Arpeggio Switch	OFF, ON
	MODE	Arpeggio Mode	UP, DOWN, UP & DOWN, RANDOM, RPS
	RANGE	Arpeggio Range	1OCT-4OCT
	ARP HOLD	Arpeggio Hold	OFF, ON
	TEMPO	Tempo	20-250
[PFM COMMON] (1)	Part Detune	Part Detune	-50- +50
	Output Assign	Output Assign	MIX OUT, PARALLEL OUT
	Pedal Assign	Pedal Assign	OFF, MODULATION:CC01, PANPOT:CC10, EXPRESSION:CC11, LFO1 RATE-RIBBON DOWN
	Voice Assign (Only Dual & Split Mode)	Voice Assign	6-2, 5-3, 4-4, 3-5, 2-6
	Split Point (Only Split Mode)	Split Point	C-1-G 9
	Arpeggio Dest (Only Dual Mode)	Arpeggio Destination	LOWER & UPPER, LOWER, UPPER
	Arp Beat Pattern	Arpeggio Beat Pattern	1/4, 1/6, 1/8, 1/12, 1/16, 1/32, PORTA-A1-11, PORTA-B1-15, SEQUENCE-A1-7, SEQUENCE-B1-5, SEQUENCE-C1-2, SEQUENCE-D1-8, ECHO1-3, MUTE1-16, STRUMMING1-8, REFRAIN1-2, PERCUSSION1-4, WALKING BASS, HARP, RANDOM
[INDIV TRIG] (3)	Indv Trig Switch	Individual Trigger Switch	OFF, ON
	Trig Destination	Individual Trigger Destination	FILTER, AMP, FILTER & AMP
	Trig Source CH	Individual Trigger Source Channel	1-16
	Trig Source Note	Individual Trigger Source Note	C-1-G 9, ALL

Performance Part Parameters

Parameter		Full Name of Parameter	Value
[PFM PART] (2)	Part Transpose	Part Transpose	-24- +24 semitone
	Part MIDI CH	Part MIDI Channel	1-16, OFF
	Chorus Sync	Chorus Sync	OFF, 1/16, 1/8(3), 1/16(.), 1/8, 1/4(3), 1/8(.), 1/4, 1/2(3), 1/4(.), 1/2, 1/1(3), 1/2(.), 1/1, 2/1(3), 1/1(.), 2/1, 3-8MEASURES, LFO1
	Delay Sync	Delay Sync	OFF, 1/16, 1/8(3), 1/16(.), 1/8, 1/4(3), 1/8(.), 1/4, 1/2(3), 1/4(.), 1/2
	LFO Sync	LFO Sync	OFF, 1/16, 1/8(3), 1/16(.), 1/8, 1/4(3), 1/8(.), 1/4, 1/2(3), 1/4(.), 1/2, 1/1(3), 1/2(.), 1/1, 2/1(3), 1/1(.), 2/1, 3-8MEASURES

System Parameters

Parameter		Full Name of Parameter	Value
KEYBOARD Section	KEYBOARD SHIFT	Keyboard Shift	-2OCT- +2OCT
RIBBON CONTROLLER Section	RELATIVE	Ribbon Relative	OFF, ON
	HOLD	Ribbon Hold	OFF, ON
[MIDI PRM] ([4])	Perform Ctrl CH	Performance Control Channel	1-16, OFF
	Remote Ctrl CH	Remote Control Channel	1-16, ALL, OFF
	Device ID	Device ID Number	17-32
	Tx/Rx Edit Mode	Edit Transmit/Receive Mode	MODE1,MODE2
	Tx/Rx Setting	Transmit/Receive Setting	OFF, MODULATION:CC01- CC31, CC33-PHASER:CC95, AFTERTOUCHEX, EXCLUSIVE
[MIDI SW] ([5])	Local Switch	Local Switch	OFF, ON
	MIDI Sync	MIDI Sync Switch	OFF, ON
	Tx/Rx Edit SW	Edit Transmit/Receive Switch	OFF, ON
	Rx Exclusive SW	Exclusive Receive Switch	OFF, ON
	Tx/Rx ProgChg SW	Program Change Transmit/Receive Switch	ON, PC, BANK SEL + PC
[SETUP] ([6])	Master Tune	Master Tune	427.5-452.9 Hz
	Power Up Mode	Power Up Mode	PERFORM P:11, LAST-SET
	LCD Contrast	LCD Contrast	1-8
	Pattern Trig Qtz	Pattern Trigger Quantize	OFF, BEAT, MEASURE
	Motion Restart	Motion Restart	OFF, ON
	Motion Set	Motion Set	SET A, SET B

Recording Parameters

Parameter		Full Name of Parameter	Value
Pattern	Loop Length	Pattern Loop Length	1-4 measures
	Input Quantize	Input Quantize	OFF, 1/16(3), 1/16, 1/8(3), 1/8, 1/4(3), 1/4
	Gate Time Ratio	Gate Time Ratio	REAL, STACCATO, 33%, 50%, 66%, 100%
	Metronome	Pattern Metronome	Type1: VOLUME 4-1, OFF, Type2: VOLUME 1-4
Motion	Loop Length	Motion Loop Length	1-8 measures
	Metronome	Motion Metronome	Type1: VOLUME 4-1, OFF, Type2: VOLUME 1-4

Transmit/Receive Setting List

Parameter Name	MODE1	MODE2 (Factory Setting)	
LFO1 Section	RATE	GENERAL1:CC16	GENERAL1:CC16
	FADE	EXCLUSIVE	CC20
OSC COMMON Section	OSC BALANCE	BALANCE:CC08	BALANCE:CC08
	X-MOD DEPTH	SOUND-CTL1:CC70	SOUND-CTL1:CC70
	LFO1 DEPTH	GENERAL3:CC18	GENERAL3:CC18
	ENV DEPTH	EXCLUSIVE	CC25
	A	EXCLUSIVE	CC26
	D	EXCLUSIVE	CC27
OSC1 Section	CTRL1	FOOT-TYPE:CC04	FOOT-TYPE:CC04
	CTRL2	SOUND-CTL7:CC76	SOUND-CTL7:CC76
OSC2 Section	RANGE	EXCLUSIVE	CC21
	FINE/WIDE	SOUND-CTL8:CC77	SOUND-CTL8:CC77
	PULSE WIDTH	SOUND-CTL9:CC78	SOUND-CTL9:CC78
	PWM DEPTH	SOUND-CTL10:CC79	SOUND-CTL10:CC79
FILTER Section	CUTOFF FREQ	SOUND-CTL5:CC74	SOUND-CTL5:CC74
	RESONANCE	SOUND-CTL2:CC71	SOUND-CTL2:CC71
	KEY FOLLOW	EXCLUSIVE	CC30
	LFO1 DEPTH	GENERAL4:CC19	GENERAL4:CC19
	ENV DEPTH	GENERAL6:CC81	GENERAL6:CC81
	A	GENERAL7:CC82	GENERAL7:CC82
	D	GENERAL8:CC83	GENERAL8:CC83
	S	EXCLUSIVE	CC28
R	EXCLUSIVE	CC29	
AMP Section	LEVEL	VOLUME:CC07	VOLUME:CC07
	LFO1 DEPTH/PAN	GENERAL5:CC80	GENERAL5:CC80
	A	SOUND-CTL4:CC73	SOUND-CTL4:CC73
	D	SOUND-CTL6:CC75	SOUND-CTL6:CC75
	S	EXCLUSIVE	CC31
	R	SOUND-CTL3:CC72	SOUND-CTL3:CC72
TONE CONTROL Section	BASS	TREMOLO:CC92	TREMOLO:CC92
	TREBLE	PHASER:CC95	PHASER:CC95
CHORUS Section	LEVEL	CHORUS:CC93	CHORUS:CC93
DELAY Section	TIME	EFFECT-CTL1:CC12	EFFECT-CTL1:CC12
	FEEDBACK	EFFECT-CTL2:CC13	EFFECT-CTL2:CC13
	LEVEL	SELESTE:CC94	SELESTE:CC94
KEYBOARD Section	TIME	PORTA-TIME:CC05	PORTA-TIME:CC05
LFO2 Section	RATE	GENERAL2:CC17	GENERAL2:CC17
	DEPTH (PITCH)	EXCLUSIVE	CC22
	DEPTH (FILTER)	EXCLUSIVE	CC23
	DEPTH (AMP)	EXCLUSIVE	CC24
RIBBON UP *		AFTERTOUCH	
RIBBON DOWN *		BREATH:CC02	

* Ribbon controller Transmit/Receive Settings are valid regardless of whether Edit Transmit/Receive Mode is set to MODE 1 or MODE

Mark	Meaning	Range
n:	MIDI channel	0H-FH (ch.1 - ch.16)
vv:	Value, Velocity etc.	00H-7FH (0 - 127)
kk:	Note Number	00H-7FH (0 - 127)
xx:	ON/OFF	00H-3FH (0 - 63 : OFF), 40H-7FH (64 - 127 : ON)

1. Data reception/transmission (sound source section)

■ Channel voice messages

● Note Off

status	2nd byte	3rd byte
8nH	kkH	vvH
9nH	kkH	00H

- * If the MIDI channel number of a received Note Off coincides with the Remote Control channel, the message will have the same effect as when a note is released on the JP-8000's keyboard. This means that you can control the arpeggiator and RPS (Rec/Play) from an external MIDI keyboard.
- * When the Individual Trigger Switch is ON, and if MIDI channel number of received Note Off is coincident with Triger Source Channel, and also the Note Number of received Note Off is coincident with Trigger Source Note, the Envelope of Trigger Destination will be released.

● Note On

status	2nd byte	3rd byte
9nH	kkH	vvH

- * If the MIDI channel number of a received Note On coincides with the Remote Control channel, the message will have the same effect as when a note is played on the JP-8000's keyboard. This means that you can control the arpeggiator and RPS (Rec/Play) from an external MIDI keyboard.
- * When the Individual Trigger Switch is ON, and if MIDI channel number of received Note On is coincident with Triger Source Channel, and also the Note Number of received Note On is coincident with Trigger Source Note, the Envelope of Trigger Destination will be started.

● Control Change

- * The value specified by a Control Change messages will not be reset even by a Program Change, etc.
- * Tx/Rx Setting (p.89) is effective when Tx/Rx Edit SW (p.90) is ON and Tx/Rx Edit Mode (p.89) is MODE2.
If you operate the knobs, Control Change messages are transmitted. And if Control Change messages are received, the value of the corresponding parameters will change.
- * If Ribbon Controller is specified as the Control Change message, the message will function as Ribbon Controller operations.
- * Tx/Rx settings can be made for controller numbers 1 to 31 and 33 to 95. Refer to Transmit/Receive Setting List (p.116) for the default settings.
- * If the MIDI channel number of the received Control Change corresponds to the Remote Control Channel, and if the Tx/Rx Setting of knobs are set to Control Change messages, the response will be the same as if the knobs of the JP-8000 itself were operated. However if the Tx/Rx Edit SW system parameter is ON and if there are Patch parameters for which control changes are specified for the Tx/Rx Setting system parameter, those control changes will not have their normal function but will function in the same way as JP-8000 knob movements for those Patch parameters.

○ Bank Select (Controller number 0,32)

status	2nd byte	3rd byte
BnH	00H	mmH
BnH	20H	llH

mm, ll=Bank number: 00 00H - 7F 7FH (bank.1 - bank.16384)

- * Not received and transmitted when the Tx/Rx Program Change SW is OFF or PC.
- * Bank Select processing will be suspended until a Program Change message is received.
- * If an unavailable (nonexistent) Bank Select number is received it will be ignored, and only the Program Change will be received.
- * The Patches corresponding to each Bank Select are as follows.

Bank MSB	Select LSB	Program No.	Group	Patch No.
80	0	0 - 127	User	1 - 128
81	0	0 - 127	Preset	1 - 128

- * The Performances corresponding to each Bank Select are as follows.

Bank MSB	Select LSB	Program No.	Group	Perform No.
80	0	0 - 63	User	1 - 64
81	0	0 - 63	Preset	1 - 64

○ Modulation (Controller number 1)

status	2nd byte	3rd byte
BnH	01H	vvH

- * This can be used to control the modulation depth for pitch/cutoff/amp.

○ Breath type (Controller number 2)

status	2nd byte	3rd byte
BnH	02H	vvH

○ Foot type (Controller number 4)

status	2nd byte	3rd byte
BnH	04H	vvH

○ Portamento Time (Controller number 5)

status	2nd byte	3rd byte
BnH	05H	vvH

- * This adjusts the time of pitch change when Portamento is ON or when using the Portamento Control. A value of 0 results in the fastest change.

○ Data Entry (Controller number 6,38)

status	2nd byte	3rd byte
BnH	06H	mmH
BnH	26H	llH

mm, ll= the value of the parameter specified by RPN mm=MSB, ll=LSB

○ Volume (Controller number 7)

status	2nd byte	3rd byte
BnH	07H	vvH

- * Volume messages are used to adjust the volume balance of each Part.

○ Balance (Controller number 8)

status	2nd byte	3rd byte
BnH	08H	vvH

○ Panpot (Controller number 10)

status	2nd byte	3rd byte
BnH	0AH	vvH

- * Panpot messages are used to adjust the pan of each Part.

○ Expression (Controller number 11)

status	2nd byte	3rd byte
BnH	0BH	vvH

- * Expression messages are used to adjust the volume of each part. It can be used to independently from Volume messages. Expression messages are used for musical expression within a performance; e.g., expression pedal movements, crescendo and decrescendo.

○ Effect Control I (Controller number 12)

status	2nd byte	3rd byte
BnH	0CH	vvH

○ Effect Control2 (Controller number 13)

status 2nd byte 3rd byte
BnH 0DH vvH

○ General Purpose Controller1-4 (Controller number 16-19)

status 2nd byte 3rd byte
BnH 10-13H vvH

○ Hold1 (Controller number 64)

status 2nd byte 3rd byte
BnH 40H xxH

○ Portamento (Controller number 65)

status 2nd byte 3rd byte
BnH 41H xxH

○ Legato Footswitch (Controller number 68)

status 2nd byte 3rd byte
BnH 44H xxH

○ Sound Controller1-10 (Controller number 70-79)

status 2nd byte 3rd byte
BnH 46-4FH vvH

○ General Purpose Controllers 5-8 (Controller number 80-83)

status 2nd byte 3rd byte
BnH 50-53H vvH

○ Portamento Control (Controller number 84)

status 2nd byte 3rd byte
BnH 54H kkH

- * A Note On message received immediately after a Portamento control will be sounded with the pitch changing smoothly from the source note number.
- * If a voice is already sounding at the same note number as the source note number, that voice will change pitch to the pitch of the newly received Note On, and continue sounding (i.e., will be played legato).

Example 1.

On MIDI	Description	Result
90 3C 40	Note on C4	C4 on
B0 54 3C	(Portamento Control from C4)	no change(C4 voice still sounding)
90 40 40	Note on E4	glide from C4 to E4
80 3C 40	Note off C4	no change
80 40 40	Note off E4	E4 off

Example 2.

On MIDI	Description	Result
B0 54 3C	(Portamento Control from C4)	no change
90 40 40	(Note on E4)	E4 is played with glide from C4 to E4
80 40 40	(Note off E4)	E4 off

- * The speed of the pitch change caused by Portamento is determined by the PORTAMENTO TIME parameter value.

○ Effects Depth 2-5 (Controller number 92-95)

status 2nd byte 3rd byte
BnH 5C-5FH kkH

○ RPN LSB/MSB (Controller number 100,101)

status 2nd byte 3rd byte
BnH 65H mmH
BnH 64H llH

mm=MSB of the parameter number specified by RPN
ll=LSB of the parameter number specified by RPN

<<< RPN >>

Control Changes include RPN (Registered Parameter Numbers), which are extended parameters whose function is defined in the MIDI specification. When using RPNs, first the RPN (Controller numbers 100 and 101); they can be sent in any order) is transmitted to specify the parameter you wish to control. Then, Data Entry messages (Controller numbers 6 and 38) are used to set the value of the specified parameter. Once a RPN parameter has been specified, all further Data Entry messages on that channel are considered to apply to that specified parameter. In order to prevent accidents, when the desired setting has been made for the parameter, it is recommended that RPN be set to Null.

This device receives the following RPNs.

RPN	Data entry	Notes
MSB LSB	MSB LSB	
00H 00H	mmH —	Pitch Bend Sensitivity mm : 00H - 0CH (0 - 12 semitones) ll : ignored (processed as 00H) Up to 1 octave can be specified in semitone steps. * The Bend Range up parameter, Bend Range Down parameter will also be changed.
00H 01H	mmH llH	Master Fine Tuning mm, ll: 20 00H - 40 00H - 60 00H (-8192 * 50 / 8192 - 0 - +8192 * 50 / 8192 cent) * In Patch mode, the Master Tune parameter will change.
7FH 7FH	— —	RPN null mRPN and NRPN will be set as "unspecified". Once this setting has been made, subsequent Data Entry messages will be ignored. (It is not necessary to transmit Data Entry for RPN Null settings.) Parameter values that were previously set will not change. mm, ll: ignored

● Program Change

status 2nd byte
CnH ppH

pp=Program number : 00H - 7FH (prog.1 - prog.128)

- * Not transmitted and received when the Tx/Rx Program Change parameter is OFF.
- * When this message is received on the Performance Control channel, the Performance will change.
- * When this message is received, all voices will be turned off.

● Channel Pressure

status 2nd byte
DnH vvH

- * The Tx/Rx Setting (p.89) is effective when Tx/Rx Edit SW (p.90) is ON and Tx/Rx Edit Mode (p.89) is MODE2. You can assign Channel Pressure messages to the Ribbon Controller.
If you operate the assigned knobs, Channel Pressure messages are transmitted. When Channel Pressure messages are received, the value of the corresponding parameters will change.
- * If Channel Pressure messages are assigned to Ribbon Controller Up or Down, the messages will correspond to Ribbon Controller Up or Down operations. With the factory Settings, Channel Pressure messages are assigned to Ribbon Controller Up.
- * If the MIDI channel number on which Channel Pressure is received corresponds to the Remote Control Channel, and if the Tx/Rx Setting of the Ribbon Controller is also set to Channel Pressure, the result is same as if the Ribbon Controller of the JP-8000 itself is operated.
- * The JP-8000's keyboard does not implement Channel Pressure.

● Pitch Bend Change

status 2nd byte 3rd byte
EnH llH mmH

mm,ll=Pitch Bend value: 00 00H - 40 00H - 7F 7FH (-8192 - 0 - +8191)

- * Pitch Bend Change messages will control the pitch according to Bend Range Up/Down patch parameter.

■ Channel Mode messages

● All Sound Off (Controller number 120)

status	2nd byte	3rd byte
BnH	78H	00H

n=MIDI channel: 011 - F11 (ch.1 - ch.16)

- When this message is received, all notes currently sounding on the corresponding channel will be turned off.

● Reset All Controllers (Controller number 121)

status	2nd byte	3rd byte
BnH	79H	00H

- When this message is received, the following controllers will be set to their reset values.

Controller	Reset value
Pitch Bend Change	±0 (center)
Modulation	0 (minimum)
Expression	127 (maximum)
Hold 1	0 (off)
RPN	Unset. Previously set data will not change.
Ribbon Up	0 (minimum) Default setting is Channel Pressure.
Ribbon Down	0 (minimum) Default setting is Breath Type.

● All Note Off (Controller number 123)

status	2nd byte	3rd byte
BnH	7BH	00H

- When All Note Off is received, all currently sounding notes of the corresponding channel will be turned off. However if Hold 1 is on, the sound will be held until these are turned off.

● Omni Off (Controller number 124)

status	2nd byte	3rd byte
BnH	7CH	00H

- The same processing as when All Note Off is received will be done.

● Omni On (Controller number 125)

status	2nd byte	3rd byte
BnH	7DH	00H

- The same processing as when All Note Off is received will be done.

● Mono (Controller number 126)

status	2nd byte	3rd byte
BnH	7EH	mmH

mm=Mono number: 00H - 10H (0 - 16)

- The same processing as when All Note Off is received will be done, and the MONO Switch parameter will be set to ON.

● Poly (Controller number 127)

status	2nd byte	3rd byte
BnH	7FH	00H

- The same processing as when All Note Off is received will be done, and the MONO Switch parameter will be set to OFF.

■ System Realtime messages

● Active Sensing

status
FEH

- When an Active Sensing message is received, the unit will begin monitoring the intervals of all further messages. During monitoring, if more than 420 ms passes without a message being received, the same processing will be done as when All Sound Off, All Note Off, and Reset All Controllers messages are received. Then monitoring will be halted.

■ System Exclusive messages

status	data byte	status
F0H	iiH, ddH,, eeH	F7H

F0H: System Exclusive message status
 ii = ID number: This is the ID number (manufacturer ID) that specifies the manufacturer whose exclusive message this is. Roland's manufacturer ID is 41H. ID numbers 7EH and 7FH are defined in an expansion of the MIDI standard as Universal Non-realtime messages (7EH) and Universal Realtime Messages (7FH).

dd, ..., ee = data: 00H - 7FH (0 - 127)

F7H: EOX (End Of Exclusive)

The System Exclusive message received by the JP-8000 are; messages for Mode setting, Data request (RQ1) and Data Set (DT1).

● Data transmission

This instrument can use exclusive messages to exchange many varieties of internal settings with other devices.

The model ID of the exclusive messages used by this instrument is 00H 06H.

○ Data Request 1 RQ1

This message requests the other device to transmit data. The address and size indicate the type and amount of data that is requested.

When a Data Request message is received, if the device is in a state in which it is able to transmit data, and if the address and size are appropriate, the requested data is transmitted as a Data Set 1 (DT1) message. If the conditions are not met, nothing is transmitted.

status	data byte	status
F0H	41H, dev, 00H, 06H, 11H, aaH, bbH, ccH, ddH, ssH, ttH, uuH, sum	F7H

Byte	Remarks
F0H	Exclusive status
41H	ID number (Roland)
dev	device ID (dev: 10H - 1FH)
00H	model ID (JP-8000)
06H	model ID (JP-8000)
11H	command ID (RQ1)
aaH	address MSB
bbH	address
ccH	address
ddH	address LSB
ssH	size MSB
ttH	size
uuH	size
vvH	size LSB
sum	checksum
F7H	EOX (End Of Exclusive)

- The size of data that can be transmitted at one time is fixed for each type of data, and data requests must be made with a fixed starting address and size. Refer to the address and size given in "5. Parameter address map" (p.121)
- For the checksum, refer to page 127.

○ Data Set 1 DT1

This message transmits the actual data, and is used when you wish to set the data of the receiving device.

status	data byte	status
F0H	41H, dev, 00H, 06H, 12H, aaH, bbH, ccH, ddH, eeH, ... ffH, sum	F7H

Byte	Remarks
F0H	Exclusive status
41H	ID number (Roland)
dev	device ID (dev: 10H - 1FH)
00H	model ID (JP-8000)
06H	model ID (JP-8000)
12H	command ID (DT1)
aaH	address MSB
bbH	address
ccH	address
ddH	address LSB
eeH	data: The actual data to be transmitted. Multi-byte data is transmitted in the order of the address.
:	:
ffH	data
sum	checksum
F7H	EOX (End Of Exclusive)

- * The amount of data that is transmitted at one time is fixed for the type of data, and only data of the fixed starting address and size will be transmitted. Refer to the address and size given in "5. Parameter address map" (p.121).
- * Data whose size is greater than 128 bytes should be divided into packets of 128 bytes or less and transmitted. Successive "Data Set 1 messages should have at least 20 ms of time interval between them.
- * For the checksum please refer to page 127.
- * This message is not received if Rx Exclusive SW is OFF.

2. Data reception/transmission (Arpeggiator/RPS section)

The MIDI channel of the transmitted MIDI message depends on the setting of KEY MODE, ARPEGGIATOR DESTINATION, PANEL SELECT and PART MIDI CH.

■ Transmitted messages during playing ARPEGGIATOR/RPS

- Note Off (See p.117)
- Note On (See p.117)
- Portamento control (Controller number 84) (See p.118)

■ Messages recorded/played back by RPS

- Note Off (See p.117)
- Note On (See p.117)

3. Messages acknowledged for synchronization

■ System Realtime messages (Received only)

● Timing Clock

status
F8H

- * This message will be received if the MIDI Sync SW is ON.

● Start

status
FAH

- * This message will be received if the MIDI Sync SW is ON.

● Continue

status
FBH

- * This message will be received if the MIDI Sync SW is ON.

● Stop

status
FCH

- * This message will be received if the MIDI Sync SW is ON.

4. Messages automatically generated by the system

■ Channel Mode messages

● Omni Off (Controller number 124)

status	2nd byte	3rd byte
BnH	7CH	00H

- * At start-up, this message is transmitted to all channels.

● Poly (Controller number 127)

status	2nd byte	3rd byte
BnH	7FH	00H

- * At start-up, this message is transmitted to all channels.

5. Parameter address map

IP-8000 (Model ID = 00H 06H)

* For addresses marked by a #, the data must be divided into 2 parts for transmission. For example, data with the hexadecimal value ABH would be divided into 0AH and 0BH, and transmitted in that order.

Start Address	Description	
00 00 00 00	System Area	1-1
01 00 00 00	Performance Temporary Area	1-2
02 00 00 00	User Patch (Patch U:All - U:B88)	1-4
03 00 00 00	User Performance (Performance U:11 - U:88)	1-5
08 00 00 00	Pattern Data (Pattern 1 - 48)	1-6
09 00 00 00	Motion Controller Data (Motion A, Motion B)	1-7

1-1. System Area

Offset Address	Description	
00 00 00 00	System parameter	1-1-1
00 00 10 00	Pattern Setup	1-1-2
00 00 20 00	Motion Setup	1-1-3
00 00 30 00	Tx/Rx Setting	1-1-4

1-1-1. System Parameter size = 17h (23 byte)

Offset Address	Parameter Name	Sys.Ex.Value	Meaning of Value
00 00 00 00	Performance Bank	01h - 02h	USER, PRESET
00 00 00 01	Performance No.	00h - 3Fh	11 - 88
00 00 00 02	Performance Control Channel	00h - 10h	1 - 16, OFF
00 00 00 03	Power Up Mode	00h - 01h	PERFORM P:11, LAST-SET
00 00 00 04	MIDI Sync	00h - 01h	OFF, ON
00 00 00 05	Local Switch	00h - 01h	OFF, ON
00 00 00 06	Tx/Rx Edit Mode	00h - 01h	MODEL, MODE2
00 00 00 07	Tx/Rx Edit Switch	00h - 01h	OFF, ON
00 00 00 08	Tx/Rx Program Change Switch	00h - 02h	OFF, PC, BANK SEL + PC
00 00 00 09	Remote Control Channel	00h - 11h	1 - 16, ALL, OFF
00 00 00 0A	Master Tune	00h - 64h	427.5 - 452.9 [Hz]
00 00 00 0B	Pattern Trigger Quantize	00h - 02h	OFF, BEAT, MEASURE
00 00 00 0C	Motion Restart	00h - 01h	OFF, ON
00 00 00 0D	Motion Set	00h - 01h	SET A, SET B
00 00 00 0E	Gate Time Ratio	00h - 05h	REAL, STACCATO, 33%, 50%, 66%, 100%
00 00 00 0F	Input Quantize	00h - 06h	OFF, 1/16(3), 1/16, 1/8(3), ..., 1/4
00 00 00 10	Pattern Metronome	00h - 08h	TYPE1 VOL4 - 1, OFF, TYEP2 VOL1 - 4
00 00 00 11	Motion Metronome	00h - 08h	TYPE1 VOL4 - 1, OFF, TYEP2 VOL1 - 4
00 00 00 12	Factory Preset Menu	00h - 0Dh	PATCH:TEMP, ..., MOTION:SET B-2, F.PRESET
00 00 00 13	Bulk Dump Menu	00h - 11h	ALL, PATCH:USER ALL, ..., MOTION:SET B-2
00 00 00 14	Keyboard Shift	00h - 04h	-2 - +2 [octave]
00 00 00 15	Ribbon Relative	00h - 01h	OFF, ON
00 00 00 16	Ribbon Hold	00h - 01h	OFF, ON

1-1-2. Pattern Setup size = 30h (48 byte)

Offset Address	Parameter Name	Sys.Ex.Value	Meaning of Value
00 00 00 00	Pattern 1 Loop length	01h - 04h	1 - 4 [measure]
00 00 00 01	Pattern 2 Loop length	01h - 04h	1 - 4 [measure]
00 00 00 02	Pattern 3 Loop length	01h - 04h	1 - 4 [measure]
:	:	:	:
00 00 00 2F	Pattern 48 Loop length	01h - 04h	1 - 4 [measure]

1-1-3. Motion Setup size = 04h (4 byte)

Offset Address	Parameter Name	Sys.Ex.Value	Meaning of Value
00 00 00 00	Motion Controller A1 Loop length	01h - 08h	1 - 8 [measure]
00 00 00 01	Motion Controller A2 Loop length	01h - 08h	1 - 8 [measure]
00 00 00 02	Motion Controller B1 Loop length	01h - 08h	1 - 8 [measure]
00 00 00 03	Motion Controller B2 Loop length	01h - 08h	1 - 8 [measure]

1-1-4. Tx/Rx Setting size = 2Ah (42 byte)

Offset	Address	Parameter Name	Sys.Ex.Value	Meaning of Value
00 00 00 00		Tx/Rx Setting (LFO1 Rate)	00h - 60h	OFF, CC#1-31, AFTER, CC#33-95, SYSEX
00 00 00 01		Tx/Rx Setting (LFO1 Fade)	00h - 60h	OFF, CC#1-31, AFTER, CC#33-95, SYSEX
00 00 00 02		Tx/Rx Setting (LFO2 Rate)	00h - 60h	OFF, CC#1-31, AFTER, CC#33-95, SYSEX
00 00 00 03		Tx/Rx Setting (Cross Modulation Depth)	00h - 60h	OFF, CC#1-31, AFTER, CC#33-95, SYSEX
00 00 00 04		Tx/Rx Setting (Oscillator Balance)	00h - 60h	OFF, CC#1-31, AFTER, CC#33-95, SYSEX
00 00 00 05		Tx/Rx Setting (OSC LFO1 Depth)	00h - 60h	OFF, CC#1-31, AFTER, CC#33-95, SYSEX
00 00 00 06		Tx/Rx Setting (Pitch LFO2 Depth)	00h - 60h	OFF, CC#1-31, AFTER, CC#33-95, SYSEX
00 00 00 07		Tx/Rx Setting (OSC Env. Depth)	00h - 60h	OFF, CC#1-31, AFTER, CC#33-95, SYSEX
00 00 00 08		Tx/Rx Setting (OSC Env. Attack Time)	00h - 60h	OFF, CC#1-31, AFTER, CC#33-95, SYSEX
00 00 00 09		Tx/Rx Setting (OSC Env. Decay Time)	00h - 60h	OFF, CC#1-31, AFTER, CC#33-95, SYSEX
00 00 00 0A		Tx/Rx Setting (OSC1 Control1)	00h - 60h	OFF, CC#1-31, AFTER, CC#33-95, SYSEX
00 00 00 0B		Tx/Rx Setting (OSC1 Control2)	00h - 60h	OFF, CC#1-31, AFTER, CC#33-95, SYSEX
00 00 00 0C		Tx/Rx Setting (OSC2 Range)	00h - 60h	OFF, CC#1-31, AFTER, CC#33-95, SYSEX
00 00 00 0D		Tx/Rx Setting (OSC2 Fine Tune)	00h - 60h	OFF, CC#1-31, AFTER, CC#33-95, SYSEX
00 00 00 0E		Tx/Rx Setting (OSC2 Control1)	00h - 60h	OFF, CC#1-31, AFTER, CC#33-95, SYSEX
00 00 00 0F		Tx/Rx Setting (OSC2 Control2)	00h - 60h	OFF, CC#1-31, AFTER, CC#33-95, SYSEX
00 00 00 10		Tx/Rx Setting (Cutoff Frequency)	00h - 60h	OFF, CC#1-31, AFTER, CC#33-95, SYSEX
00 00 00 11		Tx/Rx Setting (Resonance)	00h - 60h	OFF, CC#1-31, AFTER, CC#33-95, SYSEX
00 00 00 12		Tx/Rx Setting (Cutoff Key Follow)	00h - 60h	OFF, CC#1-31, AFTER, CC#33-95, SYSEX
00 00 00 13		Tx/Rx Setting (Filter LFO1 Depth)	00h - 60h	OFF, CC#1-31, AFTER, CC#33-95, SYSEX
00 00 00 14		Tx/Rx Setting (Filter LFO2 Depth)	00h - 60h	OFF, CC#1-31, AFTER, CC#33-95, SYSEX
00 00 00 15		Tx/Rx Setting (Filter Env Depth)	00h - 60h	OFF, CC#1-31, AFTER, CC#33-95, SYSEX
00 00 00 16		Tx/Rx Setting (Filter Env Attack Time)	00h - 60h	OFF, CC#1-31, AFTER, CC#33-95, SYSEX
00 00 00 17		Tx/Rx Setting (Filter Env Decay Time)	00h - 60h	OFF, CC#1-31, AFTER, CC#33-95, SYSEX
00 00 00 18		Tx/Rx Setting (Filter Env Sus. Level)	00h - 60h	OFF, CC#1-31, AFTER, CC#33-95, SYSEX
00 00 00 19		Tx/Rx Setting (Filter Env Rel. Time)	00h - 60h	OFF, CC#1-31, AFTER, CC#33-95, SYSEX
00 00 00 1A		Tx/Rx Setting (Amplifier Level)	00h - 60h	OFF, CC#1-31, AFTER, CC#33-95, SYSEX
00 00 00 1B		Tx/Rx Setting (Amplifier LFO1 Depth)	00h - 60h	OFF, CC#1-31, AFTER, CC#33-95, SYSEX
00 00 00 1C		Tx/Rx Setting (Amplifier LFO2 Depth)	00h - 60h	OFF, CC#1-31, AFTER, CC#33-95, SYSEX
00 00 00 1D		Tx/Rx Setting (Amp. Env. Attack Time)	00h - 60h	OFF, CC#1-31, AFTER, CC#33-95, SYSEX
00 00 00 1E		Tx/Rx Setting (Amp. Env. Decay Time)	00h - 60h	OFF, CC#1-31, AFTER, CC#33-95, SYSEX
00 00 00 1F		Tx/Rx Setting (Amp. Env. Sus. Level)	00h - 60h	OFF, CC#1-31, AFTER, CC#33-95, SYSEX
00 00 00 20		Tx/Rx Setting (Amp. Env. Release Time)	00h - 60h	OFF, CC#1-31, AFTER, CC#33-95, SYSEX
00 00 00 21		Tx/Rx Setting (Tone Control Base)	00h - 60h	OFF, CC#1-31, AFTER, CC#33-95, SYSEX
00 00 00 22		Tx/Rx Setting (Tone Control Treble)	00h - 60h	OFF, CC#1-31, AFTER, CC#33-95, SYSEX
00 00 00 23		Tx/Rx Setting (Chorus Level)	00h - 60h	OFF, CC#1-31, AFTER, CC#33-95, SYSEX
00 00 00 24		Tx/Rx Setting (Delay Time)	00h - 60h	OFF, CC#1-31, AFTER, CC#33-95, SYSEX
00 00 00 25		Tx/Rx Setting (Delay Feedback)	00h - 60h	OFF, CC#1-31, AFTER, CC#33-95, SYSEX
00 00 00 26		Tx/Rx Setting (Delay Level)	00h - 60h	OFF, CC#1-31, AFTER, CC#33-95, SYSEX
00 00 00 27		Tx/Rx Setting (Portamento Time)	00h - 60h	OFF, CC#1-31, AFTER, CC#33-95, SYSEX
00 00 00 28		Tx/Rx Setting (Ribbon Controller Up)	00h - 5Fh	OFF, CC#1-31, AFTER, CC#33-95, SYSEX
00 00 00 29		Tx/Rx Setting (Ribbon Controller Down)	00h - 5Fh	OFF, CC#1-31, AFTER, CC#33-95, SYSEX

1-2. Performance

Offset	Address	Description
00 00 00 00		Performance Common
00 00 10 00		Performance Part (Upper)
00 00 11 00		Performance Part (Lower)
00 00 40 00		Patch (Upper)
00 00 42 00		Patch (Lower)

1-2-1. Performance Common size = 24h (36 byte)

Offset	Address	Parameter Name	Sys.Ex.Value	Meaning of Value
00 00 00 00		Performance Name 1	20h - 7Dh	ASCII Code
00 00 00 01		Performance Name 2	20h - 7Dh	ASCII Code
00 00 00 02		Performance Name 3	20h - 7Dh	ASCII Code
00 00 00 03		Performance Name 4	20h - 7Dh	ASCII Code
00 00 00 04		Performance Name 5	20h - 7Dh	ASCII Code
00 00 00 05		Performance Name 6	20h - 7Dh	ASCII Code
00 00 00 06		Performance Name 7	20h - 7Dh	ASCII Code
00 00 00 07		Performance Name 8	20h - 7Dh	ASCII Code
00 00 00 08		Performance Name 9	20h - 7Dh	ASCII Code
00 00 00 09		Performance Name 10	20h - 7Dh	ASCII Code
00 00 00 0A		Performance Name 11	20h - 7Dh	ASCII Code
00 00 00 0B		Performance Name 12	20h - 7Dh	ASCII Code
00 00 00 0C		Performance Name 13	20h - 7Dh	ASCII Code
00 00 00 0D		Performance Name 14	20h - 7Dh	ASCII Code
00 00 00 0E		Performance Name 15	20h - 7Dh	ASCII Code
00 00 00 0F		Performance Name 16	20h - 7Dh	ASCII Code
00 00 00 10		Key Mode	00h - 02h	SINGLE, DUAL, SPLIT
00 00 00 11		Split Point	00h - 7Fh	C-1 - G9(*)
00 00 00 12		Panel Select	00h - 02h	UPPER, LOWER, UPPER&LOWER
00 00 00 13		Part Detune	00h - 64h	-50 +50
00 00 00 14		Output Assign	00h - 01h	MIX OUT, PARARELL OUT
00 00 00 15		Arpeggio Destination	00h - 02h	LOWER&UPPER, LOWER, UPPER (**)
00 00 00 16		Voice Assign	00h - 04h	6-2, 5-3, 4-4, 3-5, 2-6 (***)
00 00 00 17		Arpeggio Switch	00h - 01h	OFF, ON
00 00 00 18		Arpeggio Mode	00h - 04h	UP, DOWN, UP&DOWN, RANDOM, RPS
00 00 00 19		Arpeggio Beat Pattern	00h - 59h	1/4, 1/6, ... SEQUENCE-A1, ..., RANDOM
00 00 00 1A		Arpeggio Octave Range	00h - 03h	1 - 4 [octave]
00 00 00 1B		Arpeggio Hold	00h - 01h	OFF, ON
00 00 00 1C		Pedal Assign	00h - 2Dh	OFF, MODULATION, PANPOT, ...
00 00 00 1D		Individual Trigger Switch	00h - 01h	OFF, ON
00 00 00 1E		Individual Trigger Destination	00h - 02h	FILTER ENV, AMPLIFIER ENV, FILTER&
00 00 00 1F		Individual Trigger Source Channel	00h - 0Fh	1 - 16
#00 00 00 20		Individual Trigger Source Note MSB	00h - 01h	C-1 - G9, ALL
00 00 00 21		Individual Trigger Source Note LSB	00h - 7Fh	
#00 00 00 22		Tempo MSB	00h - 01h	20 - 250 (beat/minute)
00 00 00 23		Tempo LSB	00h - 7Fh	

- (*) "Split Point" parameter is effective only when "Key Mode" parameter is SPLIT.
- (**) "Arpeggio Destination" parameter is effective only when "Key Mode" parameter is DUAL.
- (***) "Voice Assign" parameter is effective only when "Key Mode" parameter is DUAL or SPLIT.

1-2-2. Performance Part size = 07h (7 byte)

Offset	Address	Parameter Name	Sys.Ex.Value	Meaning of Value
00 00 00 00		Patch Bank	00h - 02h	IN PERFORMANCE, USER, PRESET (*)
00 00 00 01		Patch No.	00h - 7Fh	All - B88 (*)
00 00 00 02		Part MIDI Channel	00h - 10h	1 - 16, OFF
00 00 00 03		Part Transpose	00h - 30h	-24 - +24 [semitone]
00 00 00 04		Delay Sync	00h - 0Ah	OFF, 1/16, 1/8(3), 1/16(.),...
00 00 00 05		LFO Sync	00h - 16h	OFF, 1/16, 1/8(3), 1/16(.),...
00 00 00 06		Chorus Sync	00h - 17h	OFF, 1/16, 1/8(3), 1/16(.),...

(*) The Patches changes if received "Patch No." when "Patch Bank" parameter is 1 or 2.

1-3. Patch

size = 01 6Fh (239 byte)

Offset	Address	Parameter Name	Sys. Ex. Value	Meaning of Value
00 00 00 00		Patch Name 1	20h - 7Fh	ASCII Code
00 00 00 01		Patch Name 2	20h - 7Dh	ASCII Code
00 00 00 02		Patch Name 3	20h - 7Dh	ASCII Code
00 00 00 03		Patch Name 4	20h - 7Dh	ASCII Code
00 00 00 04		Patch Name 5	20h - 7Dh	ASCII Code
00 00 00 05		Patch Name 6	20h - 7Dh	ASCII Code
00 00 00 06		Patch Name 7	20h - 7Dh	ASCII Code
00 00 00 07		Patch Name 8	30h - 7Dh	ASCII Code
00 00 00 08		Patch Name 9	20h - 7Dh	ASCII Code
00 00 00 09		Patch Name 10	20h - 7Dh	ASCII Code
00 00 00 0A		Patch Name 11	20h - 7Dh	ASCII Code
00 00 00 0B		Patch Name 12	20h - 7Dh	ASCII Code
00 00 00 0C		Patch Name 13	20h - 7Dh	ASCII Code
00 00 00 0D		Patch Name 14	20h - 7Dh	ASCII Code
00 00 00 0E		Patch Name 15	20h - 7Dh	ASCII Code
00 00 00 0F		Patch Name 16	20h - 7Dh	ASCII Code
00 00 00 10		LFO1 Waveform	00h - 03h	TRI, SAW, SQR, S/H
00 00 00 11		LFO1 Rate	00h - 7Fh	0 - 127
00 00 00 12		LFO1 Fade	00h - 7Fh	0 - 127
00 00 00 13		LFO2 Rate	00h - 7Fh	0 - 127
00 00 00 14		LFO2 Depth Select	00h - 02h	PITCH, FILTER, AMPLIFIER
00 00 00 15		Ring Modulator Switch	00h - 01h	OFF, ON
00 00 00 16		Cross Modulation Depth	00h - 7Fh	0 - 127
00 00 00 17		Oscillator Balance	00h - 7Fh	-64(OSC1) - +63(OSC2)
00 00 00 18		LFO1 & Envelope Destination	00h - 02h	OSC1+2, OSC2, X-MOD DEPTH
00 00 00 19		OSC LFO1 Depth	00h - 7Fh	-64 - +63
00 00 00 1A		Pitch LFO2 Depth	00h - 7Fh	-64 - +63
00 00 00 1B		OSC Envelope Depth	00h - 7Fh	-64 - +63
00 00 00 1C		OSC Envelope Attack Time	00h - 7Fh	0 - 127
00 00 00 1D		OSC Envelope Decay Time	00h - 7Fh	0 - 127
00 00 00 1E		OSC1 Waveform	00h - 06h	SUPER SAW, TWM, ..., PULSE, SAW, TRI
00 00 00 1F		OSC1 Control1	00h - 7Fh	0 - 127
00 00 00 20		OSC1 Control2	00h - 7Fh	0 - 127
00 00 00 21		OSC2 Waveform	00h - 02h	PULSE, TRI, SAW
00 00 00 22		OSC2 Sync Switch	00h - 01h	OFF, ON
00 00 00 23		OSC2 Range	00h - 32h	-WIDE, -24 - +24, +WIDE
00 00 00 24		OSC2 Fine/Wide	00h - 64h	-50 - +50 [cent]
00 00 00 25		OSC2 Control1 (Pulse Width)	00h - 7Fh	0 - 127
00 00 00 26		OSC2 Control2 (PWM Depth)	00h - 7Fh	0 - 127
00 00 00 27		Filter Type	00h - 02h	HPF, BPF, LPF
00 00 00 28		Cutoff Slope	00h - 01h	-12, -24 [dB/oct]
00 00 00 29		Cutoff Frequency	00h - 7Fh	0 - 127
00 00 00 2A		Resonance	00h - 7Fh	0 - 127
00 00 00 2B		Cutoff Frequency Key Follow	00h - 7Fh	0 - 127
00 00 00 2C		Filter LFO1 Depth	00h - 7Fh	-64 - +63
00 00 00 2D		Filter LFO2 Depth	00h - 7Fh	-64 - +63
00 00 00 2E		Filter Envelope Depth	00h - 7Fh	-64 - +63
00 00 00 2F		Filter Envelope Attack Time	00h - 7Fh	0 - 127
00 00 00 30		Filter Envelope Decay Time	00h - 7Fh	0 - 127
00 00 00 31		Filter Envelope Sustain Level	00h - 7Fh	0 - 127
00 00 00 32		Filter Envelope Release Time	00h - 7Fh	0 - 127
00 00 00 33		Amplifier Level	00h - 7Fh	0 - 127
00 00 00 34		Amplifier LFO1 Depth	00h - 7Fh	-64 - +63 (*)
00 00 00 35		Amplifier LFO2 Depth	00h - 7Fh	-64 - +63
00 00 00 36		Amplifier Envelope Attack Time	00h - 7Fh	0 - 127
00 00 00 37		Amplifier Envelope Decay Time	00h - 7Fh	0 - 127
00 00 00 38		Amplifier Envelope Sustain Level	00h - 7Fh	0 - 127
00 00 00 39		Amplifier Envelope Release Time	00h - 7Fh	0 - 127
00 00 00 3A		Auto Pan/Manual Pan Switch	00h - 02h	OFF, AUTO PAN, MANUAL PAN (*)
00 00 00 3B		Tone Control Bass	00h - 7Fh	-64 - +63
00 00 00 3C		Tone Control Treble	00h - 7Fh	-64 - +63
00 00 00 3D		Chorus Type	00h - 0Bh	SUPER CHORUS SLW, ..., FREEZE PHASE 2
00 00 00 3E		Chorus Level	00h - 7Fh	0 - 127
00 00 00 3F		Delay Type	00h - 04h	PANNING L > R, ..., MONO LONG
00 00 00 40		Delay Time	00h - 7Fh	0 - 127
00 00 00 41		Delay Feedback	00h - 7Fh	0 - 127
00 00 00 42		Delay Level	00h - 7Fh	0 - 127
00 00 00 43		Bend Range Up	00h - 18h	0 - 24 [semitone]
00 00 00 44		Bend Range Down	00h - 18h	0 - 24 [semitone]
00 00 00 45		Portamento Switch	00h - 01h	OFF, ON
00 00 00 46		Portamento Time	00h - 7Fh	0 - 127
00 00 00 47		Mono Switch	00h - 01h	OFF, ON
00 00 00 48		Legato Switch	00h - 01h	OFF, ON
00 00 00 49		Oscillator Shift	00h - 04h	-2 - +2 [octave]
#00 00 00 4A		Ribbon: LFO1 Rate MSB	00h - 01h	00h - 7Fh - FEh as -127 - 0 - +127
00 00 00 4B		Ribbon: LFO1 Rate LSB	00h - 7Fh	
#00 00 00 4C		Ribbon: LFO1 Fade MSB	00h - 01h	00h - 7Fh - FEh as -127 - 0 - +127
00 00 00 4D		Ribbon: LFO1 Fade LSB	00h - 7Fh	
#00 00 00 4E		Ribbon: LFO2 Rate MSB	00h - 01h	00h - 7Fh - FEh as -127 - 0 - +127
00 00 00 4F		Ribbon: LFO2 Rate LSB	00h - 7Fh	
#00 00 00 50		Ribbon: Cross Modulation Depth MSB	00h - 01h	00h - 7Fh - FEh as -127 - 0 - +127
00 00 00 51		Ribbon: Cross Modulation Depth LSB	00h - 7Fh	
#00 00 00 52		Ribbon: Oscillator Balance MSB	00h - 01h	00h - 7Fh - FEh as -127 - 0 - +127
00 00 00 53		Ribbon: Oscillator Balance LSB	00h - 7Fh	
#00 00 00 54		Ribbon: Pitch LFO1 Depth MSB	00h - 01h	00h - 7Fh - FEh as -127 - 0 - +127
00 00 00 55		Ribbon: Pitch LFO1 Depth LSB	00h - 7Fh	
#00 00 00 56		Ribbon: Pitch LFO2 Depth MSB	00h - 01h	00h - 7Fh - FEh as -127 - 0 - +127
00 00 00 57		Ribbon: Pitch LFO2 Depth LSB	00h - 7Fh	
#00 00 00 58		Ribbon: OSC Envelope Depth MSB	00h - 01h	00h - 7Fh - FEh as -127 - 0 - +127
00 00 00 59		Ribbon: OSC Envelope Depth LSB	00h - 7Fh	
#00 00 00 5A		Ribbon: OSC Envelope Attack Time MSB	00h - 01h	00h - 7Fh - FEh as -127 - 0 - +127
00 00 00 5B		Ribbon: OSC Envelope Attack Time LSB	00h - 7Fh	
#00 00 00 5C		Ribbon: OSC Envelope Decay Time MSB	00h - 01h	00h - 7Fh - FEh as -127 - 0 - +127
00 00 00 5D		Ribbon: OSC Envelope Decay Time LSB	00h - 7Fh	
#00 00 00 5E		Ribbon: OSC1 Control1 MSB	00h - 01h	00h - 7Fh - FEh as -127 - 0 - +127
00 00 00 5F		Ribbon: OSC1 Control1 LSB	00h - 7Fh	
#00 00 00 60		Ribbon: OSC1 Control2 MSB	00h - 01h	00h - 7Fh - FEh as -127 - 0 - +127
00 00 00 61		Ribbon: OSC1 Control2 LSB	00h - 7Fh	
#00 00 00 62		Ribbon: OSC2 Range MSB	00h - 01h	4Dh - 7Fh - B1h as -50 - 0 - +50
00 00 00 63		Ribbon: OSC2 Range LSB	00h - 7Fh	
#00 00 00 64		Ribbon: OSC2 Fine/Wide MSB	00h - 01h	1Bh - 7Fh - E3h as -100 - 0 - +100
00 00 00 65		Ribbon: OSC2 Fine/Wide LSB	00h - 7Fh	
#00 00 00 66		Ribbon: OSC2 Control1 MSB	00h - 01h	00h - 7Fh - FEh as -127 - 0 - +127
00 00 00 67		Ribbon: OSC2 Control1 LSB	00h - 7Fh	
#00 00 00 68		Ribbon: OSC2 Control2 MSB	00h - 01h	00h - 7Fh - FEh as -127 - 0 - +127
00 00 00 69		Ribbon: OSC2 Control2 LSB	00h - 7Fh	
#00 00 00 6A		Ribbon: Cutoff Frequency MSB	00h - 01h	00h - 7Fh - FEh as -127 - 0 - +127
00 00 00 6B		Ribbon: Cutoff Frequency LSB	00h - 7Fh	
#00 00 00 6C		Ribbon: Resonance MSB	00h - 01h	00h - 7Fh - FEh as -127 - 0 - +127
00 00 00 6D		Ribbon: Resonance LSB	00h - 7Fh	
#00 00 00 6E		Ribbon: Cutoff Freq. Key Follow MSB	00h - 01h	00h - 7Fh - FEh as -127 - 0 - +127
00 00 00 6F		Ribbon: Cutoff Freq. Key Follow LSB	00h - 7Fh	
#00 00 00 70		Ribbon: Filter LFO1 Depth MSB	00h - 01h	00h - 7Fh - FEh as -127 - 0 - +127
00 00 00 71		Ribbon: Filter LFO1 Depth LSB	00h - 7Fh	
#00 00 00 72		Ribbon: Filter LFO2 Depth MSB	00h - 01h	00h - 7Fh - FEh as -127 - 0 - +127
00 00 00 73		Ribbon: Filter LFO2 Depth LSB	00h - 7Fh	
#00 00 00 74		Ribbon: Filter Env. Depth MSB	00h - 01h	00h - 7Fh - FEh as -127 - 0 - +127
00 00 00 75		Ribbon: Filter Env. Depth LSB	00h - 7Fh	
#00 00 00 76		Ribbon: Filter Env. Attack Time MSB	00h - 01h	00h - 7Fh - FEh as -127 - 0 - +127
00 00 00 77		Ribbon: Filter Env. Attack Time LSB	00h - 7Fh	
#00 00 00 78		Ribbon: Filter Env. Decay Time MSB	00h - 01h	00h - 7Fh - FEh as -127 - 0 - +127
00 00 00 79		Ribbon: Filter Env. Decay Time LSB	00h - 7Fh	

#00 00 00 79	Ribbon: Filter Env. Decay Time LSB	00h - 7Fh	
#00 00 00 7A	Ribbon: Filter Env. Sustain Level MSB	00h - 01h	00h - 7Fh - FEh as -127 - 0 - +127
00 00 00 7B	Ribbon: Filter Env. Sustain Level LSB	00h - 7Fh	
#00 00 00 7C	Ribbon: Filter Env. Release Time MSB	00h - 01h	00h - 7Fh - FEh as -127 - 0 - +127
00 00 00 7D	Ribbon: Filter Env. Release Time LSB	00h - 7Fh	
#00 00 00 7E	Ribbon: Amplifier Level MSB	00h - 01h	00h - 7Fh - FEh as -127 - 0 - +127
00 00 00 7F	Ribbon: Amplifier Level LSB	00h - 7Fh	
#00 00 01 00	Ribbon: Amplifier LFO1 Depth MSB	00h - 01h	00h - 7Fh - FEh as -127 - 0 - +127
00 00 01 01	Ribbon: Amplifier LFO1 Depth LSB	00h - 7Fh	
#00 00 01 02	Ribbon: Amplifier LFO2 Depth MSB	00h - 01h	00h - 7Fh - FEh as -127 - 0 - +127
00 00 01 03	Ribbon: Amplifier LFO2 Depth LSB	00h - 7Fh	
#00 00 01 04	Ribbon: Amp. Env. Attack Time MSB	00h - 01h	00h - 7Fh - FEh as -127 - 0 - +127
00 00 01 05	Ribbon: Amp. Env. Attack Time LSB	00h - 7Fh	
#00 00 01 06	Ribbon: Amp. Env. Decay Time MSB	00h - 01h	00h - 7Fh - FEh as -127 - 0 - +127
00 00 01 07	Ribbon: Amp. Env. Decay Time LSB	00h - 7Fh	
#00 00 01 08	Ribbon: Amp. Env. Sustain Level MSB	00h - 01h	00h - 7Fh - FEh as -127 - 0 - +127
00 00 01 09	Ribbon: Amp. Env. Sustain Level LSB	00h - 7Fh	
#00 00 01 0A	Ribbon: Amp. Env. Release Time MSB	00h - 01h	00h - 7Fh - FEh as -127 - 0 - +127
00 00 01 0B	Ribbon: Amp. Env. Release Time LSB	00h - 7Fh	
#00 00 01 0C	Ribbon: Tone Control Bass MSB	00h - 01h	00h - 7Fh - FEh as -127 - 0 - +127
00 00 01 0D	Ribbon: Tone Control Bass LSB	00h - 7Fh	
#00 00 01 0E	Ribbon: Tone Control Treble MSB	00h - 01h	00h - 7Fh - FEh as -127 - 0 - +127
00 00 01 0F	Ribbon: Tone Control Treble LSB	00h - 7Fh	
#00 00 01 10	Ribbon: Chorus Level MSB	00h - 01h	00h - 7Fh - FEh as -127 - 0 - +127
00 00 01 11	Ribbon: Chorus Level LSB	00h - 7Fh	
#00 00 01 12	Ribbon: Delay Time MSB	00h - 01h	00h - 7Fh - FEh as -127 - 0 - +127
00 00 01 13	Ribbon: Delay Time LSB	00h - 7Fh	
#00 00 01 14	Ribbon: Delay Feedback MSB	00h - 01h	00h - 7Fh - FEh as -127 - 0 - +127
00 00 01 15	Ribbon: Delay Feedback LSB	00h - 7Fh	
#00 00 01 16	Ribbon: Delay Level MSB	00h - 01h	00h - 7Fh - FEh as -127 - 0 - +127
00 00 01 17	Ribbon: Delay Level LSB	00h - 7Fh	
#00 00 01 18	Ribbon: Bend Switch	00h - 01h	0 - 1
#00 00 01 19	Ribbon: Portamento Time MSB	00h - 01h	00h - 7Fh - FEh as -127 - 0 - +127
00 00 01 1A	Ribbon: Portamento Time LSB	00h - 7Fh	
#00 00 01 1B	Velocity Switch	00h - 01h	OFF, ON
#00 00 01 1C	Velocity: LFO1 Rate MSB	00h - 01h	00h - 7Fh - FEh as -127 - 0 - +127
00 00 01 1D	Velocity: LFO1 Rate LSB	00h - 7Fh	
#00 00 01 1E	Velocity: LFO1 Fade MSB	00h - 01h	00h - 7Fh - FEh as -127 - 0 - +127
00 00 01 1F	Velocity: LFO1 Fade LSB	00h - 7Fh	
#00 00 01 20	Velocity: LFO2 Rate MSB	00h - 01h	00h - 7Fh - FEh as -127 - 0 - +127
00 00 01 21	Velocity: LFO2 Rate LSB	00h - 7Fh	
#00 00 01 22	Velocity: Cross Modulation Depth MSB	00h - 01h	00h - 7Fh - FEh as -127 - 0 - +127
00 00 01 23	Velocity: Cross Modulation Depth LSB	00h - 7Fh	
#00 00 01 24	Velocity: Oscillator Balance MSB	00h - 01h	00h - 7Fh - FEh as -127 - 0 - +127
00 00 01 25	Velocity: Oscillator Balance LSB	00h - 7Fh	
#00 00 01 26	Velocity: Pitch LFO1 Depth MSB	00h - 01h	00h - 7Fh - FEh as -127 - 0 - +127
00 00 01 27	Velocity: Pitch LFO1 Depth LSB	00h - 7Fh	
#00 00 01 28	Velocity: Pitch LFO2 Depth MSB	00h - 01h	00h - 7Fh - FEh as -127 - 0 - +127
00 00 01 29	Velocity: Pitch LFO2 Depth LSB	00h - 7Fh	
#00 00 01 2A	Velocity: OSC Envelope Depth MSB	00h - 01h	00h - 7Fh - FEh as -127 - 0 - +127
00 00 01 2B	Velocity: OSC Envelope Depth LSB	00h - 7Fh	
#00 00 01 2C	Velocity: OSC Envelope Attack Time MSB	00h - 01h	00h - 7Fh - FEh as -127 - 0 - +127
00 00 01 2D	Velocity: OSC Envelope Attack Time LSB	00h - 7Fh	
#00 00 01 2E	Velocity: OSC Envelope Decay Time MSB	00h - 01h	00h - 7Fh - FEh as -127 - 0 - +127
00 00 01 2F	Velocity: OSC Envelope Decay Time LSB	00h - 7Fh	
#00 00 01 30	Velocity: OSC1 Control1 MSB	00h - 01h	00h - 7Fh - FEh as -127 - 0 - +127
00 00 01 31	Velocity: OSC1 Control1 LSB	00h - 7Fh	
#00 00 01 32	Velocity: OSC1 Control2 MSB	00h - 01h	00h - 7Fh - FEh as -127 - 0 - +127
00 00 01 33	Velocity: OSC1 Control2 LSB	00h - 7Fh	
#00 00 01 34	Velocity: OSC2 Range MSB	00h - 01h	4Dh - 7Fh - B1h as -50 - 0 - +50
00 00 01 35	Velocity: OSC2 Range LSB	00h - 7Fh	
#00 00 01 36	Velocity: OSC2 Fine/Wide MSB	00h - 01h	1Bh - 7Fh - E3h as -100 - 0 - +100
00 00 01 37	Velocity: OSC2 Fine/Wide LSB	00h - 7Fh	
#00 00 01 38	Velocity: OSC2 Control1 MSB	00h - 01h	00h - 7Fh - FEh as -127 - 0 - +127
00 00 01 39	Velocity: OSC2 Control1 LSB	00h - 7Fh	
#00 00 01 3A	Velocity: OSC2 Control2 MSB	00h - 01h	00h - 7Fh - FEh as -127 - 0 - +127
00 00 01 3B	Velocity: OSC2 Control2 LSB	00h - 7Fh	
#00 00 01 3C	Velocity: Cutoff Frequency MSB	00h - 01h	00h - 7Fh - FEh as -127 - 0 - +127
00 00 01 3D	Velocity: Cutoff Frequency LSB	00h - 7Fh	
#00 00 01 3E	Velocity: Resonance MSB	00h - 01h	00h - 7Fh - FEh as -127 - 0 - +127
00 00 01 3F	Velocity: Resonance LSB	00h - 7Fh	
#00 00 01 40	Velocity: Cutoff Freq. Key Follow MSB	00h - 01h	00h - 7Fh - FEh as -127 - 0 - +127
00 00 01 41	Velocity: Cutoff Freq. Key Follow LSB	00h - 7Fh	
#00 00 01 42	Velocity: Filter LFO1 Depth MSB	00h - 01h	00h - 7Fh - FEh as -127 - 0 - +127
00 00 01 43	Velocity: Filter LFO1 Depth LSB	00h - 7Fh	
#00 00 01 44	Velocity: Filter LFO2 Depth MSB	00h - 01h	00h - 7Fh - FEh as -127 - 0 - +127
00 00 01 45	Velocity: Filter LFO2 Depth LSB	00h - 7Fh	
#00 00 01 46	Velocity: Filter Env. Depth MSB	00h - 01h	00h - 7Fh - FEh as -127 - 0 - +127
00 00 01 47	Velocity: Filter Env. Depth LSB	00h - 7Fh	
#00 00 01 48	Velocity: Filter Env. Attack Time MSB	00h - 01h	00h - 7Fh - FEh as -127 - 0 - +127
00 00 01 49	Velocity: Filter Env. Attack Time LSB	00h - 7Fh	
#00 00 01 4A	Velocity: Filter Env. Decay Time MSB	00h - 01h	00h - 7Fh - FEh as -127 - 0 - +127
00 00 01 4B	Velocity: Filter Env. Decay Time LSB	00h - 7Fh	
#00 00 01 4C	Velocity: Filter Env. Sus. Level MSB	00h - 01h	00h - 7Fh - FEh as -127 - 0 - +127
00 00 01 4D	Velocity: Filter Env. Sus. Level LSB	00h - 7Fh	
#00 00 01 4E	Velocity: Filter Env. Release Time MSB	00h - 01h	00h - 7Fh - FEh as -127 - 0 - +127
00 00 01 4F	Velocity: Filter Env. Release Time LSB	00h - 7Fh	
#00 00 01 50	Velocity: Amplifier Level MSB	00h - 01h	00h - 7Fh - FEh as -127 - 0 - +127
00 00 01 51	Velocity: Amplifier Level LSB	00h - 7Fh	
#00 00 01 52	Velocity: Amplifier LFO1 Depth MSB	00h - 01h	00h - 7Fh - FEh as -127 - 0 - +127
00 00 01 53	Velocity: Amplifier LFO1 Depth LSB	00h - 7Fh	
#00 00 01 54	Velocity: Amplifier LFO2 Depth MSB	00h - 01h	00h - 7Fh - FEh as -127 - 0 - +127
00 00 01 55	Velocity: Amplifier LFO2 Depth LSB	00h - 7Fh	
#00 00 01 56	Velocity: Amp. Env. Attack Time MSB	00h - 01h	00h - 7Fh - FEh as -127 - 0 - +127
00 00 01 57	Velocity: Amp. Env. Attack Time LSB	00h - 7Fh	
#00 00 01 58	Velocity: Amp. Env. Decay Time MSB	00h - 01h	00h - 7Fh - FEh as -127 - 0 - +127
00 00 01 59	Velocity: Amp. Env. Decay Time LSB	00h - 7Fh	
#00 00 01 5A	Velocity: Amp. Env. Sustain Level MSB	00h - 01h	00h - 7Fh - FEh as -127 - 0 - +127
00 00 01 5B	Velocity: Amp. Env. Sustain Level LSB	00h - 7Fh	
#00 00 01 5C	Velocity: Amp. Env. Release Time MSB	00h - 01h	00h - 7Fh - FEh as -127 - 0 - +127
00 00 01 5D	Velocity: Amp. Env. Release Time LSB	00h - 7Fh	
#00 00 01 5E	Velocity: Tone Control Bass MSB	00h - 01h	00h - 7Fh - FEh as -127 - 0 - +127
00 00 01 5F	Velocity: Tone Control Bass LSB	00h - 7Fh	
#00 00 01 60	Velocity: Tone Control Treble MSB	00h - 01h	00h - 7Fh - FEh as -127 - 0 - +127
00 00 01 61	Velocity: Tone Control Treble LSB	00h - 7Fh	
#00 00 01 62	Velocity: Chorus Level MSB	00h - 01h	00h - 7Fh - FEh as -127 - 0 - +127
00 00 01 63	Velocity: Chorus Level LSB	00h - 7Fh	
#00 00 01 64	Velocity: Delay Time MSB	00h - 01h	00h - 7Fh - FEh as -127 - 0 - +127
00 00 01 65	Velocity: Delay Time LSB	00h - 7Fh	
#00 00 01 66	Velocity: Delay Feedback MSB	00h - 01h	00h - 7Fh - FEh as -127 - 0 - +127
00 00 01 67	Velocity: Delay Feedback LSB	00h - 7Fh	
#00 00 01 68	Velocity: Delay Level MSB	00h - 01h	00h - 7Fh - FEh as -127 - 0 - +127
00 00 01 69	Velocity: Delay Level LSB	00h - 7Fh	
#00 00 01 6A	Velocity: Portamento Time MSB	00h - 01h	00h - 7Fh - FEh as -127 - 0 - +127
00 00 01 6B	Velocity: Portamento Time LSB	00h - 7Fh	
00 00 01 6C	Active Indicator of Bender	00h - 01h	NOT ACTIVE, ACTIVE
00 00 01 6D	Active Indicator of Velocity	00h - 01h	NOT ACTIVE, ACTIVE
00 00 01 6E	Active Indicator of Ribbon	00h - 01h	NOT ACTIVE, ACTIVE

(*) "Amplifier LFO1 Depth" is regarded as Pan LFO Depth when "Auto Pan/Manual Pan Switch" is ON.

1-4. User Patch Area

Offset	Address	Description
00 00 00 00	User Patch 1 (A11)	1-3
00 00 02 00	User Patch 2 (A12)	1-3
00 00 04 00	User Patch 3 (A13)	1-3
00 00 06 00	User Patch 4 (A14)	1-3
:	:	:
00 00 7C 00	User Patch 63 (A87)	1-3
00 00 7E 00	User Patch 64 (A88)	1-3
00 01 00 00	User Patch 65 (B11)	1-3
00 01 04 00	User Patch 67 (B13)	1-3
:	:	:
00 01 7C 00	User Patch 127 (B87)	1-3
00 01 7E 00	User Patch 128 (B88)	1-3

1-5. User Performance Area

Offset	Address	Description
00 00 00 00	User Performance 1 (11)	1-2
00 01 00 00	User Performance 2 (12)	1-2
00 02 00 00	User Performance 3 (13)	1-2
00 03 00 00	User Performance 4 (14)	1-2
:	:	:
00 3D 00 00	User Performance 62 (86)	1-2
00 3E 00 00	User Performance 63 (87)	1-2
00 3F 00 00	User Performance 64 (88)	1-2

1-6. Pattern Data

Offset	Address	Description
00 00 00 00	Pattern 1 Data	
00 01 00 00	Pattern 2 Data	
00 02 00 00	Pattern 3 Data	
00 03 00 00	Pattern 4 Data	
:	:	:
00 2E 00 00	Pattern 47 Data	
00 2F 00 00	Pattern 48 Data	

1-7. Motion Controller Data

Offset	Address	Description
00 00 00 00	Motion Controller A Data	
00 40 00 00	Motion Controller B Data	

■ Address block map

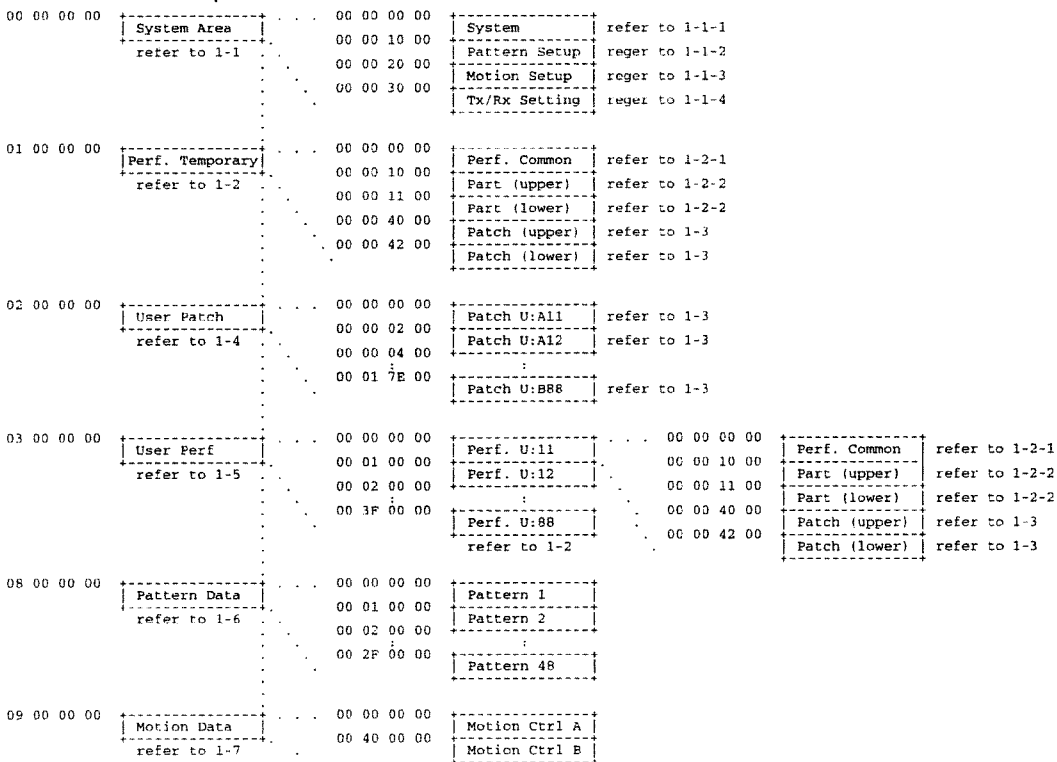

6. Supplementary material

● Decimal/Hexadecimal table

(hexadecimal values are indicated by a following "H")

MIDI uses 7-bit hexadecimal values to indicate data values and the address and size of exclusive messages. The following table shows the correspondence between decimal and hexadecimal numbers.

D	H	D	H	D	H	D	H
0	00H	32	20H	64	40H	96	60H
1	01H	33	21H	65	41H	97	61H
2	02H	34	22H	66	42H	98	62H
3	03H	35	23H	67	43H	99	63H
4	04H	36	24H	68	44H	100	64H
5	05H	37	25H	69	45H	101	65H
6	06H	38	26H	70	46H	102	66H
7	07H	39	27H	71	47H	103	67H
8	08H	40	28H	72	48H	104	68H
9	09H	41	29H	73	49H	105	69H
10	0AH	42	2AH	74	4AH	106	6AH
11	0BH	43	2BH	75	4BH	107	6BH
12	0CH	44	2CH	76	4CH	108	6CH
13	0DH	45	2DH	77	4DH	109	6DH
14	0EH	46	2EH	78	4EH	110	6EH
15	0FH	47	2FH	79	4FH	111	6FH
16	10H	48	30H	80	50H	112	70H
17	11H	49	31H	81	51H	113	71H
18	12H	50	32H	82	52H	114	72H
19	13H	51	33H	83	53H	115	73H
20	14H	52	34H	84	54H	116	74H
21	15H	53	35H	85	55H	117	75H
22	16H	54	36H	86	56H	118	76H
23	17H	55	37H	87	57H	119	77H
24	18H	56	38H	88	58H	120	78H
25	19H	57	39H	89	59H	121	79H
26	1AH	58	3AH	90	5AH	122	7AH
27	1BH	59	3BH	91	5BH	123	7BH
28	1CH	60	3CH	92	5CH	124	7CH
29	1DH	61	3DH	93	5DH	125	7DH
30	1EH	62	3EH	94	5EH	126	7EH
31	1FH	63	3FH	95	5FH	127	7FH

D: decimal

H: hexadecimal

- Decimal expressions such as used for MIDI channel, Bank Select, and Program Change will be the value 1 greater than the decimal value given in the above table.
- Since each MIDI byte carries 7 significant data bits, each byte can express a maximum of 128 different values. Data for which higher resolution is required must be transmitted using two or more bytes. For example a value indicated as a two-byte value of aa bbH would have a value of $aa \times 128 + bb$.
- For a signed number (+/-), 00H = -64, 40H = +/-, and 7FH = +63. I.e., the decimal equivalent will be 64 less than the decimal value given in the above table. For a two-byte signed number, 00 00H = -8192, 40 00H = +/-, and 7F 7FH = +8191. For example the decimal expression of aa bbH would be $aa \text{ bbH} - 40 \text{ 00H} = (aa \times 128 + bb - 64) \times 128$.
- Hexadecimal notation in two 4-bit units is used for data indicated as 'nibbled'. The nibbled two-byte value of 0a 0b H would be a $\times 16 + b$.

<Example 1> What is the decimal equivalent of 5AH?

From the above table, 5AH = 90.

<Example 2> What is the decimal equivalent of the 7-bit hexadecimal values 12 34H?

From the above table, 12H = 18 and 34H = 52
Thus, $18 \times 128 + 52 = 2356$

<Example 3> What is the decimal equivalent of the nibbled expression 0A 03 09 0DH?

From the above table, 0AH = 10, 03H = 3, 09H = 9, 0DH = 13
Thus, the result is $((10 \times 16 + 3) \times 16 + 9) \times 16 + 13 = 41885$

<Example 4> What is the nibbled equivalent of the decimal number 1258?

```

16 | 1258
   | 78 ... 10
   | 4 ... 14
   | 0 ... 4

```

From the above table, 0=00H, 4=04H, 14=0EH, 10=0A1H
Thus the result is 00 04 0E 0A1H

○ Examples of actual MIDI messages

<Example 1> 92 3E 5F

9n is the Note On status and 'n' is the MIDI channel number. Since 2H = 2, 3EH = 62, and 5FH = 95, this is a Note On message of MIDI CH = 3, note number 62 (note name D4) and velocity 95.

<Example 2> CE 49

CnH is the Program Change status and 'n' is the MIDI channel number. Since EH = 14, and 49H = 73, this is a Program Change message of MIDI CH = 15, Program number 74 (in the GS sound map, Flute).

<Example 3> EA 00 28

EnH is the Pitch Bend Change status and 'n' is the MIDI channel number. The 2nd byte (00H=0) is the LSB of the Pitch Bend value, and the 3rd byte (28H=40) is the MSB. However since the Pitch Bend is a signed number with 0 at 40 00H ($= 64 \times 128 + 0 = 8192$), the Pitch Bend value in this case is

$$28 \text{ 00H} - 40 \text{ 00H} = 40 \times 128 + 0 - (64 \times 128 + 0) = 5120 - 8192 = -3072$$

If we assume that the Pitch Bend Sensitivity is set to two semitones, the pitch will change only -200 cents for a Pitch Bend value of -8192 (00 00H). Thus, this message is specifying a Pitch Bend of $-200 \times (-3072) / (-8192) = -75$ cents on MIDI CH = 11.

<Example 4> B3 64 00 65 00 06 0C 26 00 64 7F 65 7F

BnH is the Control Change status, and 'n' is the MIDI channel number. In Control Change messages, the 2nd byte is the controller number, and the 3rd byte is the parameter value. MIDI allows what is known as "running status," when if messages of the the same status follow each other, it is permitted to omit the second and following status bytes. In the message above, running status is being used, meaning that the message has the following content.

```

B3 64 00  MIDI CH = 4, RPN parameter number LSB:      00H
(B3) 65 00  MIDI CH = 4, RPN parameter number MSB:      00H
(B3) 06 0C  MIDI CH = 4, parameter value MSB:           0CH
(B3) 26 00  MIDI CH = 4, parameter value LSB:           00H
(B3) 64 7F  MIDI CH = 4, RPN parameter number LSB:      7FH
(B3) 65 7F  MIDI CH = 4, RPN parameter number MSB:      7FH

```

Thus, this message transmits a parameter value of 0C 00H to RPN parameter number 00 00H on MIDI CH = 4, and then sets the RPN parameter number to 7F 7FH.

The function assigned to RPN parameter number 00 00H is Pitch Bend Sensitivity, and the MSB of the parameter value indicates semitone steps. Since the MSB of this parameter value is 0CH = 12, the maximum width of pitch bend is being set to +/-12 semitones (1 octave) (GS sound sources ignore the LSB of Pitch Bend Sensitivity, but it is best to transmit the LSB (parameter value 0) as well, so that the message can be correctly received by any device).

Once the parameter number has been set for RPN or NRPN, all subsequent Data Entry messages on that channel will be effective. Thus, it is recommended that after you have made the change you want, you set the parameter number to 7F 7FH (an 'unset' or 'null' setting). The final (B3) 64 7F (B3) 65 7F is for this purpose.

It is not a good idea to store many events within the data of a song (e.g., a Standard MIDI File song) using running status as shown in <Example 4>. When the song is paused, fast-forwarded or rewound, the sequencer may not be able to transmit the proper status, causing the sound source to misinterpret the data. It is best to attach the proper status byte to all events.

It is also important to transmit RPN or NRPN parameter number settings and parameter values in the correct order. In some sequencers, data events recorded in the same clock (or a nearby clock) can sometimes be transmitted in an order other than the order in which they were recorded. It is best to record such events at an appropriate interval (1 tick at TPQN=96, or 5 ticks at TPQN=480).

- TPQN: Ticks Per Quarter Note (i.e., the time resolution of the sequencer)

○ Examples of exclusive messages and calculating the checksum

Roland exclusive messages (RQ1, DT1) are transmitted with a checksum at the end of the data (before F7) to check that the data was received correctly. The value of the checksum is determined by the address and data (or size) of the exclusive message.

◇ How to calculate the checksum (hexadecimal values are indicated by a 'H')

The checksum consists of a value whose lower 7 bits are 0 when the address, size and checksum itself are added.

The following formula shows how to calculate the checksum when the exclusive message to be transmitted has an address of aa bb cc ddH, and data or size of ee ffH.

$$\begin{aligned} &aa + bb + cc + dd + ee + ff = \text{total} \\ &\text{total} / 128 = \text{quotient} \dots \text{remainder} \\ &128 \cdot \text{remainder} = \text{checksum} \end{aligned}$$

<Example 1> Setting the Temporary Performance Upper Part Transpose to +5 (DT1).

The "Parameter address map" indicates that the starting address of the Temporary Performance is 01 00 00 00H, that Temporary Performance upper Part offset address is 10 00H, Part Transpose is 00 03H. Thus, the address is:

$$\begin{array}{r} 01\ 00\ 00\ 00\text{H} \\ 10\ 00\text{H} \\ +) 00\ 03\text{H} \\ \hline 01\ 00\ 10\ 03\text{H} \end{array}$$

Since +5 is parameter value 1DH,

F0 41 10 00 06 12 01 00 00 28 1D ?? F7
(1) (2) (3) (4) (5) address data checksum (6)

(1) Exclusive status (2) ID number (Roland) (3) device ID(17)
(4) model ID (JP-8000) (5) command ID (DT1) (6) EOX

Next we calculate the checksum.

$$\begin{aligned} &01\text{H} + 00\text{H} + 10\text{H} + 03\text{H} + 1\text{DH} = 1 + 0 + 16 + 3 + 29 = 49 \text{ (sum)} \\ &49 \text{ (total)} \div 128 = 0 \text{ (quotient)} \dots 49 \text{ (remainder)} \\ &\text{checksum} = 128 \cdot 0 \text{ (quotient)} = 79 = 4\text{FH} \end{aligned}$$

This means that the message transmitted will be F0 41 10 00 06 12 01 00 03 1D 4F F7 .

<Example 2> Retrieving data for Patch of Performance USER:13 Lower Part.

The "Parameter address map" indicates that the starting address of the User Performance is 03 00 00 00H, the start address of Performance USER:13 is 03 00 00 00H, and that the offset address of Performance Lower Part is 00 00 42 00H. Thus, the address is:

$$\begin{array}{r} 03\ 00\ 00\ 00\text{H} \\ 00\ 02\ 00\ 00\text{H} \\ +) 00\ 00\ 42\ 00\text{H} \\ \hline 03\ 02\ 42\ 00\text{H} \end{array}$$

Since the size of the Performance Part is 03 02 42 00H,

F0 41 10 00 06 11 03 02 42 00 00 00 01 6D ?? F7
(1) (2) (3) (4) (5) address data checksum (6)

(1) Exclusive status (2) ID number (Roland) (3) device ID(17)
(4) model ID (JP-8000) (5) command ID (DT1) (6) EOX

Next we calculate the checksum.

$$\begin{aligned} &03\text{H} + 02\text{H} + 42\text{H} + 00\text{H} + 00\text{H} + 01\text{H} + 6\text{FH} = 3 + 2 + 66 + 0 + 0 + 0 + 1 + 111 = 183 \text{ (sum)} \\ &183 \text{ (total)} \div 128 = 1 \text{ (quotient)} \dots 55 \text{ (remainder)} \\ &\text{checksum} = 128 \cdot 1 \text{ (quotient)} = 73 = 49\text{H} \end{aligned}$$

Thus, a message of F0 41 10 00 06 11 03 02 42 00 00 01 6D 49 F7 would be transmitted.

<Example 3> Retrieving data for Temporary Performance (RQ1)

The "Parameter address map" gives the following start addresses for Temporary Performance data.

- 01 00 00 00H Temporary Performance Common
- 01 00 10 00H Part (Upper)
- 01 00 11 00H Part (Lower)
- 01 00 40 00H Patch(Upper)
- 01 00 42 00H Patch(Lower)

Since Patch has a size of 00 00 01 6FH, we add that size to the start address of the Temporary Patch Lower Part, resulting in:

$$\begin{array}{r} 01\ 00\ 42\ 00\text{H} \\ +) 00\ 00\ 01\ 6\text{FH} \\ \hline 01\ 00\ 43\ 6\text{FH} \end{array}$$

Thus, the Size for the retrieved data will be:

$$\begin{array}{r} 01\ 00\ 43\ 6\text{FH} \\ -) 01\ 00\ 00\ 00\text{H} \\ \hline 00\ 00\ 43\ 6\text{FH} \end{array}$$

F0 41 10 00 06 11 01 00 00 00 00 00 43 6F ?? F7
(1) (2) (3) (4) (5) address size checksum (6)

(1) Exclusive status (2) ID number (Roland) (3) device ID(17)
(4) model ID (JP-8000) (5) command ID (RQ1) (6) EOX

Calculating the checksum as shown in <Example 2>, we get a message of F0 41 10 00 06 11 01 00 00 00 00 43 6FH 4F F7 to be transmitted.

● ASCII code table

Char	Hex.	Char	Hex.	Char	Hex.	Char	Hex.
SP	20H	a	61H	0	30H	:	3AH
A	41H	b	62H	1	31H	;	3BH
B	42H	c	63H	2	32H	<	3CH
C	43H	d	64H	3	33H	=	3DH
D	44H	e	65H	4	34H	>	3EH
E	45H	f	66H	5	35H	?	3FH
F	46H	g	67H	6	36H	@	40H
G	47H	h	68H	7	37H		5BH
H	48H	i	69H	8	38H	\	5CH
I	49H	j	6AH	9	39H]	5DH
J	4AH	k	6BH	!	21H	^	5EH
K	4BH	l	6CH	"	22H	_	5FH
L	4CH	m	6DH	#	23H	~	60H
M	4DH	n	6EH	\$	24H	{	7BH
N	4EH	o	6FH	%	25H	}	7CH
O	4FH	p	70H	&	26H	~	7DH
P	50H	q	71H	'	27H		
Q	51H	r	72H	(28H		
R	52H	s	73H)	29H		
S	53H	t	74H	*	2AH		
T	54H	u	75H	+	2BH		
U	55H	v	76H	,	2CH		
V	56H	w	77H	-	2DH		
W	57H	x	78H	.	2EH		
X	58H	y	79H	/	2FH		
Y	59H	z	7AH				
Z	5AH						

Note: SP indicates "space".

MIDI Implementation Chart

Function...		Transmitted	Recognized	Remarks
Basic Channel	Default Changed	1-16 1-16	1-16 1-16	
Mode	Default Messages Altered	Mode 3 MONO, POLY *****	Mode 3 Mode 3, 4 (M=1)	* 2
Note Number :	True Voice	12-108 *****	0-127 0-127	
Velocity	Note ON Note OFF	O * 3 O * 3	O * 3 O * 3	
After Touch	Key's Ch's	x O * 4	x O * 4	
Pitch Bend		O	O	
Control Change	0-95	O * 1, * 4	O * 1, * 4	See page 117
Prog Change	: True #	O * 1 *****	O * 1 0-127	Program Number 1-128
System Exclusive		O * 1, * 4	O * 1, * 4	
System Common	: Song Pos : Song Sel : Tune	x x x	O x x	
System Real Time	: Clock : Commands : Start : Stop	x x x x	O * 1 x O O	
Aux Message	: All sound off : Reset all controllers : Local ON/OFF : All Notes OFF : Active Sense : Reset	x x x x O x	O O x O (123-127) O x	
Notes		* 1 O x is selectable. * 2 Recognized as M=1 even if M≠1. * 3 RPS patterns can record and playback these messages. * 4 Motions can record and playback these messages (except for Control Change 0, 32).		

Mode 1 : OMNI ON, POLY

Mode 2 : OMNI ON, MONO

O : Yes

Mode 3 : OMNI OFF, POLY

Mode 4 : OMNI OFF, MONO

X : No

Specifications

Synthesizer Section

- **Parts**
2 (Upper/Lower)
- **Maximum polyphony**
8 Voices
- **Waveform**
SUPER SAW
TRIANGLE MOD
NOISE
FEEDBACK OSC
SQUARE (PWM)
SAW
TRIANGLE
- **Effects**
Tone Control
Chorus
Delay
- **Internal Memory**
Patches User : 128
 Preset : 128
Performances User : 64
 Preset : 64
- **Controllers**
Ribbon Controller
Pitch Bend Lever/Modulation Lever
Expression Pedal (Accessory)
Hold Pedal (Accessory)

Arpeggiator/RPS Section

- **Arpeggio Mode**
UP
DOWN
UP&DOWN
RANDOM
- **Pattern Data (Internal Memory)**
Patterns : 48
Maximum Loop Length (Measures) : 4
- **Resolution**
24 ticks per quarter note
- **Recording Method**
realtime
- **Tempo**
20 to 250

Motion Control Section

- **Motion Data (Internal Memory)**
Motions : 4
Maximum Loop Length (Measures) : 8
- **Recording Method**
realtime
- **Tempo**
20 to 250

Others

- **keyboard**
49 Keys (with Velocity)
 - **Display**
16 characters, 2 lines (backlit LCD)
 - **Connectors**
MIDI connectors (IN, OUT)
Output jack (L(MONO), R)
Control Pedal jack
Hold pedal jack
Headphone jack
 - **Power Supply**
AC 117 V, AC 230 V or AC 240 V
 - **Power Consumption**
24 W(AC 117 V), 28 W(AC 230 V), 20 W(AC 240 V)
 - **Dimensions**
925 (W) × 349 (D) × 113 (H) mm
36-7/16 (W) × 13-3/4 (D) × 4-1/2 (H) inches
 - **Weight**
8.0 kg/17 lbs 11 oz (except Power cord)
 - **Accessories**
Owner's Manual
Power Cord
- * In the interest of product development, the specifications for this product are subject to change without prior notice.

Index

[A]

AC inlet	12
aftertouch	89, 107
Amplifier	62
Arpeggiator	32, 75
arpeggio	32, 75
Arpeggio Beat Pattern	76, 86
Arpeggio Destination	76, 86
asterisk	27, 54
Attack Time	
Amplifier Attack Time	62
Filter Attack Time	61
Oscillator Attack Time	59
audio cable	16
Auto Pan	62

[B]

bank	20, 52
bank select	90, 94, 107
Bass	25, 64, 106
Bend Range	67, 72
BPF (Band Pass Filter)	59, 60
Bulk Dump	97

[C]

channel message	107
Chorus	26, 64, 86, 106
Chorus Sync	86
Chorus Type	26, 64
cursor	28, 54
Cross Modulation Depth	58
control change	89, 107
controller	48, 89, 96
Control 1	21, 55
Control 2	21, 55
Cutoff Frequency	21, 22, 55, 60
Cutoff Slope	60

[D]

Decay Time	
Amplifier Decay Time	62
Filter Decay Time	61
Oscillator Decay Time	59
Delay	26, 65, 86, 106
Delay Sync	86
Delay Type	65
Delay Time	25, 65
Demo Song	19
Depth (LFO 2)	73
Depth Select	73
Detune	55
Device ID Number	89
DSP Oscillator	8
Dual	46

[E]

edit	52
effects	65, 106
envelope	59, 61, 62, 105
Envelope Depth	
Filter Envelope Depth	59
Oscillator Envelope Depth	61
error message	111
exclusive Message	90, 108

[F]

Factory Preset	18, 91
Fade Time	63
Feedback	26, 65
Feedback Amount	56
Feedback Oscillator	56
Filter	59, 105
Fine Tune	57
front panel	10

[G]

Gate Time Ratio	37, 78
-----------------------	--------

[H]

Harmonics	56
Headphone	12, 16
Hold	
Arpeggio Hold	33, 75
Hold Pedal	12, 74
Ribbon Hold	67
HPF (High Pass Filter)	59, 60

[I]

Individual Trigger	
Individual Trigger Switch	88
Trigger Destination	88
Trigger Source Channel	88
Trigger Source Note	88
Initialize	18, 91
Input Quantize	37, 77

[K]

Key and Panel	11
Keyboard Shift	71
Key Follow	60
Key Mode	45

[L]	
LCD Contrast	90
Legato	70
Level	
Amplifier Level.....	62
Chorus Level.....	26, 64
Delay Level.....	26, 65
LFO Sync.....	87
LFO 1	24, 63
LFO 1 and Envelope Destination	58
LFO 1 Depth	
Amplifier LFO1 Depth	62
Filter LFO1 Depth	61
Oscillator LFO1 Depth.....	58
LFO 2	73
LFO 2 Depth.....	73
Loop Length	
Motion Loop Length.....	42, 83
Pattern Loop Length	37, 77
Local Switch	89, 96
LPF (Low Pass Filter).....	59, 60, 105
[M]	
Manual	53
Manual pan.....	62
Master Tune.....	90
maximum polyphony	48
memory	
preset memory	50
system memory	50
user memory	50
Metronome	
Motion Metronome	43, 83
Pattern Metronome	37, 78
MIDI	107
MIDI cable	16, 107
MIDI channel.....	86, 87, 89, 107
MIDI clock	90
MIDI connector	12, 107
MIDI Implementation	117
MIDI Implementation Chart.....	128
MIDI message	107
MIDI patcher	94
MIDI Sync.....	90
Mix	21, 55
Modulation Lever	11, 73
Mono	56, 70
Motion	
erasing a Motion.....	41, 84
playing a Motion	40, 81
recording Motion.....	42, 83
Motion Control	40, 81
Motion Restart.....	82, 90
Motion Set.....	82, 90

[N]	
Noise	21, 55
note message	88
note number	107
note off	68, 107
note on.....	68, 107
number	20, 52
[O]	
Offset	55
Oscillator Balance	58
Oscillator Common	58
Oscillator Shift.....	71
Oscillator 1.....	21, 55
Oscillator 2.....	57
Output Assign.....	85
output jack	12, 16
[P]	
pan	62
Panel Select	21, 52
parameter	52
Part.....	49
Part Detune.....	85
partial	104
Part MIDI Channel	86
Part Transpose	72, 86
Patch	
Preset Patch	50
storing a Patch	53
selecting a Patch	52
User Patch.....	50
Patch Name	53
Pattern	
copying a Pattern.....	80
erasing a Pattern	35, 80
playing a Pattern	34, 76
recording a Pattern.....	36, 78
Pattern Trigger Quantize.....	77, 90
Pedal	
Control Pedal	12, 74
Expression Pedal	16, 74
Hold Pedal.....	12, 74
Pedal Switch.....	16, 74
Pedal Assign.....	74
Performance	
Preset Performance	50
storing a Performance.....	27
selecting a Performance.....	20
User Performance	50
Performance Control Channel	89
Performance Name.....	28
Performance Parameter	49
Performance Common.....	49, 85
Performance Part.....	49, 86

pitch bend change.....	107
Pitch Bend Lever.....	11, 72
Portamento.....	70
Portamento Time.....	71
Power cord.....	12, 17
Power Switch.....	12, 17
Power Up Mode.....	90
program change.....	90, 94, 107
PW (Pulse Width).....	56, 58
PWM (Pulse Width Modulation).....	56, 58
PWM Depth.....	56, 58

[R]

Range	
Arpeggio Range.....	75
Oscillator 2 Range.....	57
Rate	
LFO 1 Rate.....	24, 63
LFO 2 Rate.....	74
Rear Panel.....	12
Relative.....	67
Release Time	
Amplifier Release Time.....	62
Filter Release Time.....	61
Resonance.....	21, 23, 56, 60
Ribbon Assign.....	33, 60
Ribbon Controller.....	11, 33, 60
Ribbon Scope.....	53
Ring Modulator.....	58
RPS.....	34, 76
RPS Stop.....	34
Rx Exclusive Switch.....	90

[S]

Sample and Hold.....	63
sawtooth wave.....	56, 57, 63
sequencer.....	48, 96
Shape.....	56
Single.....	45
sound source.....	48, 89, 96
Split.....	46
Split Point.....	46, 85
square wave.....	56, 57, 63
Super Saw.....	21, 55
Sustain Level	
Amplifier Sustain Level.....	62
Filter Sustain Level.....	61
Sync	
Oscillator2 Sync.....	57
Chorus Sync.....	86
Delay Sync.....	86
LFO Sync.....	87
MIDI Sync.....	90
system message.....	108
system parameter.....	89

[T]

Tempo.....	32, 75
temporary area.....	50
Temporary Scope.....	53
Time.....	26, 65
Tone Control.....	25, 64, 106
Treble.....	25, 64, 106
tremolo.....	25, 64, 106
Triangle Modulation.....	55
triangle wave.....	56, 57, 63
Trigger Source Channel.....	88
Trigger Source Note.....	88
Trigger Destination.....	88
tuning.....	90
Tx/Rx Edit Mode.....	89
Tx/Rx Edit Switch.....	90
Tx/Rx ProgChg SW.....	90
Tx/Rx Setting.....	89
Type.....	59





[V]

Velocity.....	68, 107
Velocity Assign.....	68, 88
Velocity Scope.....	53
vibrato.....	11, 73, 106
voice.....	48
Voice Assign.....	85

[W]

Waveform	
LFO 1 Waveform.....	24, 63
Oscillator 1 Waveform.....	21, 55
Oscillator 2 Waveform.....	57
Wide.....	57
wow.....	73, 106

[Others]

-12dB/-24dB.....	60
	56, 57, 63
	56, 57, 63
	63
	56, 57
	63

For Nordic Countries

Apparatus containing Lithium batteries

ADVARSEL!

Lithiumbatteri - Eksplosjonsfare ved feilagtig håndtering.
Udskiftning må kun ske med batteri af samme fabrikat og type.
Levér det brugte batteri tilbage til leverandøren.

VARNING!

Explosionsfara vid felaktigt batteribyte.
Använd samma batterityp eller en ekvivalent typ som rekommenderas av apparattillverkaren.
Kassera använt batteri enligt fabrikantens instruktion.

ADVARSEL!

Lithiumbatteri - Eksplosjonsfare.
Ved utskifting benyttes kun batteri som anbefalt av apparatfabrikanten.
Brukt batteri returneres apparatleverandøren.

VAROITUS!

Paristo voi räjähtää, jos se on virheellisesti asennettu.
Vaihda paristo ainoastaan laitevalmistajan suosittelemaan tyyppiin. Hävitä käytetty paristo valmistajan ohjeiden mukaisesti.

For Europe



This product complies with the requirements of European Directive 89/336/EEC.

For the USA

FEDERAL COMMUNICATIONS COMMISSION RADIO FREQUENCY INTERFERENCE STATEMENT

This equipment has been tested and found to comply with the limits for a Class B digital device, pursuant to Part 15 of the FCC Rules. These limits are designed to provide reasonable protection against harmful interference in a residential installation. This equipment generates, uses, and can radiate radio frequency energy and, if not installed and used in accordance with the instructions, may cause harmful interference to radio communications. However, there is no guarantee that interference will not occur in a particular installation. If this equipment does cause harmful interference to radio or television reception, which can be determined by turning the equipment off and on, the user is encouraged to try to correct the interference by one or more of the following measures:

- Reorient or relocate the receiving antenna.
- Increase the separation between the equipment and receiver.
- Connect the equipment into an outlet on a circuit different from that to which the receiver is connected.
- Consult the dealer or an experienced radio/TV technician for help.

Unauthorized changes or modification to this system can void the users authority to operate this equipment.
This equipment requires shielded interface cables in order to meet FCC class B Limit.

For Canada

CLASS B

NOTICE

This digital apparatus does not exceed the Class B limits for radio noise emissions set out in the Radio Interference Regulations of the Canadian Department of Communications.

CLASSE B

AVIS

Cet appareil numérique ne dépasse pas les limites de la classe B au niveau des émissions de bruits radioélectriques fixés dans le Règlement des signaux parasites par le ministère canadien des Communications.

Information

When you need repair service, call your local Roland Service Station or the authorized Roland distributor in your country as shown below.

ARGENTINA

Instrumentos Musicales S.A.
Florida 638
(1005) Buenos Aires
ARGENTINA
TEL: (01) 394 4029

BRAZIL

Roland Brasil Ltda.
R. Coronel Octaviano da Silveira
203 05522-010
Sao Paulo BRAZIL
TEL: (011) 843 9377

CANADA

Roland Canada Music Ltd.
(Head Office)
5480 Parkwood Way Richmond
B. C., V6V 2M4 CANADA
TEL: (0604) 270 6626

Roland Canada Music Ltd.
(Toronto Office)
Unit 2, 109 Woodbine Downs
Blvd, Etobicoke, ON
M9W 6Y1 CANADA
TEL: (0416) 213 9707

MEXICO

Casa Veerkamp, s.a. de c.v.
Av. Toluca No. 323 Col. Olivar de
los Padres 01780 Mexico D.F.
MEXICO
TEL: (525) 668 04 80

**La Casa Wagner de
Guadalajara s.a. de c.v.**
Av. Corona No. 202 S.J.
Guadalajara, Jalisco Mexico
C.P. 44100 MEXICO
TEL: (03) 613 1414

PANAMA

Productos Superiores, S.A.
Apartado 655 - Panama 1
REP. DE PANAMA
TEL: 26 3322

U. S. A.

Roland Corporation U.S.
7200 Dominion Circle
Los Angeles, CA. 90040-3696,
U. S. A.
TEL: (0213) 685 5141

VENEZUELA

Musicland Digital C.A.
Av. Francisco de Miranda,
Centro Parque de Cristal, Nivel
C2 Local 20 Caracas
VENEZUELA
TEL: (02) 285 9218

AUSTRALIA

**Roland Corporation
Australia Pty. Ltd.**
38 Campbell Avenue
Dee Why West. NSW 2099
AUSTRALIA
TEL: (02) 982 8266

NEW ZEALAND

Roland Corporation (NZ) Ltd.
97 Mt. Eden Road, Mt. Eden,
Auckland 3, NEW ZEALAND
TEL: (09) 3098 715

CHINA

**Beijing Xinghai Musical
Instruments Co., Ltd.**
2 Huangmchang Chao Yang
District, Beijing, CHINA
TEL: (010) 6774 7491

HONG KONG

Tom Lee Music Co., Ltd.
Service Division
22-32 Pun Shan Street, Tsuen
Wan, New Territories,
HONG KONG
TEL: 2415 0911

INDONESIA

PT Galestra Inti
Kompleks Perkantoran
Duta Merlin Blok E No.6-7
Jl. Gajah Mada No.3-5,
Jakarta 10130,
INDONESIA
TEL: (021) 6335416

KOREA

**Cosmos Corporation
Service Station**
261 2nd Floor Nak-Won Arcade
Jong-Ro ku, Seoul, KOREA
TEL: (02) 742 8844

MALAYSIA

Bentley Music SDN BHD
No.142, Jalan Bukit Bintang 55100
Kuala Lumpur, MALAYSIA
TEL: (03) 2443333

PHILIPPINES

G.A. Yupangco & Co. Inc.
339 Gil J. Puyat Avenue
Makati, Metro Manila 1200,
PHILIPPINES
TEL: (02) 899 9801

SINGAPORE

Swee Lee Company
BLOCK 231, Bain Street #03-23
Bras Basah Complex,
SINGAPORE 0718
TEL: 3367886

**CRISTOFORI MUSIC PTE
LTD**
335, Joo Chiat Road SINGAPORE
1542
TEL: 3450435

TAIWAN

**Siruba Enterprise (Taiwan)
Co., LTD.**
Room. 5, 9fl. No. 112 Chung Shan
N.Road Sec.2 Taipei, TAIWAN,
R.O.C.
TEL: (02) 561 3339

THAILAND

Theera Music Co., Ltd.
330 Veng Nakorn Kasem, Soi 2,
Bangkok 10100, THAILAND
TEL: (02) 2248821

BAHRAIN

Moon Stores
Bad Al Bahrain Road,
P.O.Box 20077
State of BAHRAIN
TEL: 211 005

IRAN

TARADIS
Mir Emad Ave. No. 15, 10th street
P. O. Box 15875/4171 Teheran,
IRAN
TEL: (021) 875 6524

ISRAEL

**Halilit P. Greenspoon &
Sons Ltd.**
8 Retzif Ha'aliya Hashnya St.
Tel-Aviv-Yafa ISRAEL
TEL: (03) 6823666

JORDAN

AMMAN Trading Agency
Prince Mohammed St. P. O. Box
825 Amman 11118 JORDAN
TEL: (06) 641200

KUWAIT

Easa Husain Al-Yousifi
P.O. Box 126 Safat 13002
KUWAIT
TEL: 5719499

LEBANON

A. Chahine & Fils
P.O. Box 16-5857 Gergi Zeidan St.
Chahine Building, Achrafieh
Beirut, LEBANON
TEL: (01) 335799

OMAN

**OHI Electronics & Trading
Co. LLC**
P. O. Box 889 Muscat
Sultanate of OMAN
TEL: 706 010

QATAR

Badie Studio & Stores
P.O.Box 62,
DOHA QATAR
TEL: 423554

SAUDI ARABIA

**Abdul Lattif S. Al-Ghamdi
Trading Establishment**
Middle East Commercial Center
Al-Khobar Dharan Highway
W/hamood st.
P. O. Box 3631 Al-Khobar
31952 SAUDI ARABIA
TEL: (03) 898 2332

SYRIA

**Technical Light & Sound
Center**
Khaled Ebn Al Walid St.
P.O.Box 13520
Damascus - SYRIA
TEL: (011) 2235 384

TURKEY

Barkat Sanayi ve Ticaret
Siraselvier Cad. Guney Ishani No.
86/6 Taksim, Istanbul TURKEY
TEL: (0212) 2499324

U.A.E

**Zak Electronics & Musical
Instruments Co.**
Zabeel Road, Al Sherooq Bldg.,
No. 14, Grand Floor DUBAI
U.A.E.
P.O. Box 8050DUBAI, U.A.E
TEL: (04) 360715

EGYPT

Al Fanny Trading Office
9, Ebn Hagar Ai Askalany Street,
Ard El Golf, Heliopolis, Cairo,
11341 EGYPT
TEL: (02) 4171828
(02) 4185531

KENYA

Musik Land Limited
P.O. Box 12183 Moi Avenue
Nairobi Republic of KENYA
TEL: (2) 338 346

MAURITIUS

Philanne Music Center
4th, Floor Noll, Happy World
House Sir William Newton Street
Port Luis MAURITIUS
TEL: 242 2986

REUNION

FO - YAM Marcel
25 Rue Jules MermanZL
Chaudron - BF79 97491
Ste Clotilde REUNION
TEL: 28 29 16

SOUTH AFRICA

**That Other Music Shop
(PTY) Ltd.**
11 Melle Street (Cnr Melle and
Juta Street)
Braamfontein 2001
Republic of SOUTH AFRICA
TEL: (011) 403 4105

Paul Bothner (PTY) Ltd.

17 Werdmuller Centre Claremont
7700
Republic of SOUTH AFRICA
TEL: (021) 64 4030

AUSTRIA

E. Dematte & Co.
Neu-Rum Siemens-Strasse 4
A-6040 Innsbruck P.O.Box 83
AUSTRIA
TEL: (0512) 26 44 260

BELGIUM/HOLLAND/ LUXEMBOURG

Roland Benelux N. V.
Houtstraat 1 B-2260 Oevel-
Westerlo BELGIUM
TEL: (014) 575811

BELOUSSIA

TUSHE
UL. Rabkorovskaya 17
220001 MINSK
TEL: (0172) 764-911

CYPRUS

Radex Sound Equipment Ltd.
17 Diagorou St., P.O.Box 2046,
Nicosia CYPRUS
TEL: (02) 453 426
(02) 466 423

DENMARK

Roland Scandinavia A/S
Langebrogade 6 Post Box 1937
DK-1023 Copenhagen K.
DENMARK
TEL: 32 95 3111

FRANCE

MUSIKENGRO
Zac de Follieuses 01706
Les Echets Miribel FRANCE
TEL: 472 26 2700

FINLAND

**Roland Scandinavia As,
Filial Finland**
Lautsaarentie 54 B
Fin-00201 Helsinki, FINLAND
P. O. Box No. 109
TEL: (0) 682 4020

GERMANY

**Roland Elektronische
Musikinstrumente
Handelsgesellschaft mbH.**
Oststrasse 96, 22844 Norderstedt,
GERMANY
TEL: (040) 52 60090

GREECE

V. Dimitriadis & Co. Ltd.
20, Alexandras St. & Bouboulinas
54 St. 106 82 Athens, GREECE
TEL: (01) 8232415

HUNGARY

Intermusica Ltd.
Warehouse Area 'DEPO' Pf.83
H-2046 Torokbalint, HUNGARY
TEL: (23) 338 041

IRELAND

**The Dublin Service Centre
Audio Maintenance Limited**
11 Brunswick Place Dublin 2
Republic of IRELAND
TEL: (01) 677322

ITALY

Roland Italy S. p. A.
Viale delle Industrie, 8
20020 Arese Milano, ITALY
TEL: (02) 93581311

NORWAY

**Roland Scandinavia Avd.
Kontor Norge**
Lilleakerveien 2 Postboks 95
Lilleaker N-0216 Oslo
NORWAY
TEL: 273 0074

POLAND

P. P. H. Brzostowicz Marian
UL. Blokowa 32, 03624 Warszawa
POLAND
TEL: (022) 679 44 19

PORTUGAL

**Caius - Tecnologias Audio e
Musica, Lda.**
Rue de Catarina 131
4000 Porto, PORTUGAL
TEL: (02) 38 4456

RUSSIA

PETROSHOP Ltd.
11 Sayanskaya Street Moscow
11531, RUSSIA
TEL: 095 307 4892

Slami Music Company
Sadojava-Triumfalnaja st., 16
103006 Moscow, RUSSIA
TEL: 095 209 2193

SPAIN

**Roland Electronics
de España, S. A.**
Calle Bolivia 239 08020 Barcelona,
SPAIN
TEL: (93) 308 1000

SWEDEN

Roland Scandinavia A/S
Danvik Center 28 A, 2 tr.
S-131 30 Nacka SWEDEN
TEL: (08) 702 0020

SWITZERLAND

**Roland (Switzerland) AG
Musitronic AG**
Gerberstrasse 5, CH-4410 Liestal,
SWITZERLAND
TEL: (061) 921 1615

UKRAINE

TIC-TAC
Mira Str. 19/108
P.O.Box 180
295400 Munkachuko, UKRAINE
TEL: (03131) 414-40

UNITED KINGDOM

**Roland (U.K.) Ltd., Swansea
Office**
Atlantic Close, Swansea
Enterprise Park SWANSEA
West Glamorgan SA7 9FJ,
UNITED KINGDOM
TEL: (01792) 702701

 Roland®

71451034

UPC

71451034

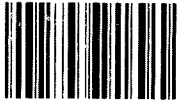

1890.

Roland