

# Roland

# RD-2000

## Owner's Manual



### What do you want to do?

You want to	Recommended functions
Play the piano	One touch piano (p. 9) Tone (p. 14)
Play various sounds	Tone (p. 14) Program (p. 15)
Place sounds in a desired order	Scene (p. 15)
Control an external device	Scene (p. 15) Assign (p. 17*) Ext Label Edit (p. 18) Connecting to your computer (p. 18)
Combine sounds as desired	Editing the Sound (p. 20) Operation Guide (p. 14)
Make settings for performance	Menu screen (p. 26) System settings (p. 26)
Use the RD-2000's functions	Using the Convenient Functions in Performances (p. 24) Operation Guide (p. 14)
Store the RD-2000's settings	Backup (p. 27)

#### Owner's Manual (this document)

Read this first. It explains the basic things you need to know in order to use the RD-2000.

#### PDF Manual (download from the Web)

- **Parameter Guide (English)**  
This explains all parameters of the RD-2000.
- **Sound List**  
This is a list of the sounds built into the unit.
- **MIDI Implementation**  
This is detailed information about MIDI messages.

#### To obtain the PDF manual

1. Enter the following URL in your computer.  
<https://www.roland.com/manuals/>



2. Choose "RD-2000" as the product name.

Before using this unit, carefully read "IMPORTANT SAFETY INSTRUCTIONS" (inside front cover), "USING THE UNIT SAFELY" (p. 2), and "IMPORTANT NOTES" (p. 4). After reading, keep the document(s) where it will be available for immediate reference.

# USING THE UNIT SAFELY

## INSTRUCTIONS FOR THE PREVENTION OF FIRE, ELECTRIC SHOCK, OR INJURY TO PERSONS

### About ⚠ WARNING and ⚠ CAUTION Notices

<b>⚠ WARNING</b>	Used for instructions intended to alert the user to the risk of death or severe injury should the unit be used improperly.
<b>⚠ CAUTION</b>	Used for instructions intended to alert the user to the risk of injury or material damage should the unit be used improperly. * Material damage refers to damage or other adverse effects caused with respect to the home and all its furnishings, as well to domestic animals or pets.

### About the Symbols

	The ⚠ symbol alerts the user to important instructions or warnings. The specific meaning of the symbol is determined by the design contained within the triangle. In the case of the symbol at left, it is used for general cautions, warnings, or alerts to danger.
	The ⓧ symbol alerts the user to items that must never be carried out (are forbidden). The specific thing that must not be done is indicated by the design contained within the circle. In the case of the symbol at left, it means that the unit must never be disassembled.
	The Ⓞ symbol alerts the user to things that must be carried out. The specific thing that must be done is indicated by the design contained within the circle. In the case of the symbol at left, it means that the power-cord plug must be unplugged from the outlet.

## ALWAYS OBSERVE THE FOLLOWING

### ⚠ WARNING

#### Make sure that the power cord is grounded

Connect mains plug of this model to a mains socket outlet with a protective earthing connection.



#### To completely turn off power to the unit, pull out the plug from the outlet

Even with the RD-2000's [⏻] switch turned off, this unit is not completely separated from its main source of power. When the power needs to be completely turned off, turn off the RD-2000's [⏻] switch on the unit, then pull out the plug from the outlet. For this reason, the outlet into which you choose to connect the power cord's plug should be one that is within easy reach and readily accessible.



#### Concerning the Auto Off function

The power to this unit will be turned off automatically after a predetermined amount of time has passed since it was last used for playing music, or its buttons or controls were operated (Auto Off function). If you do not want the power to be turned off automatically, disengage the Auto Off function (p. 11).



#### Do not disassemble or modify by yourself

Do not carry out anything unless you are instructed to do so in the owner's manual. Otherwise, you risk causing malfunction.



#### Do not repair or replace parts by yourself

Refer all servicing to your retailer, the nearest Roland Service Center, or an authorized Roland distributor, as listed on the "Information".



### ⚠ WARNING

#### Do not use or store in the following types of locations

- Subject to temperature extremes (e.g., direct sunlight in an enclosed vehicle, near a heating duct, on top of heat-generating equipment); or are
- Damp (e.g., baths, washrooms, on wet floors); or are
- Exposed to steam or smoke; or are
- Subject to salt exposure; or are
- Exposed to rain; or are
- Dusty or sandy; or are
- Subject to high levels of vibration and shakiness; or are
- Placed in a poorly ventilated location.



#### Use only the stand that is recommended

This unit should be used only with a stand that is recommended by Roland.



#### Do not place in a location that is unstable

When using the unit with a stand recommended by Roland, the stand must be carefully placed so it is level and sure to remain stable. If not using a stand, you still need to make sure that any location you choose for placing the unit provides a level surface that will properly support the unit, and keep it from wobbling.



#### Connect the power cord to an outlet of the correct voltage

The unit should be connected to a power supply only of the type described as marked on the rear side of unit.



#### Use only the supplied power cord

Use only the attached power cord. Also, the supplied power cord must not be used with any other device.



#### Do not bend the power cord or place heavy objects on it

Otherwise, fire or electric shock may result.



### ⚠ WARNING

#### Avoid extended use at high volume

Use of the unit at high volume for extended periods of time may cause hearing loss. If you ever experience any hearing loss or ringing in the ears, you should immediately stop using the unit and consult a specialized physician.



#### Do not allow foreign objects or liquids to enter unit; never place containers with liquid on unit

Do not place containers containing liquid (e.g., flower vases) on this product. Never allow foreign objects (e.g., flammable objects, coins, wires) or liquids (e.g., water or juice) to enter this product. Doing so may cause short circuits, faulty operation, or other malfunctions.



#### Turn off the unit if an abnormality or malfunction occurs

Immediately turn the unit off, remove the power cord from the outlet, and request servicing by your retailer, the nearest Roland Service Center, or an authorized Roland distributor, as listed on the "Information" when:



- The power cord has been damaged; or
- If smoke or unusual odor occurs; or
- Objects have fallen into, or liquid has been spilled onto the unit; or
- The unit has been exposed to rain (or otherwise has become wet); or
- The unit does not appear to operate normally or exhibits a marked change in performance.

#### Be cautious to protect children from injury

Always make sure that an adult is on hand to provide supervision and guidance when using the unit in places where children are present, or when a child will be using the unit.



#### Do not drop or subject to strong impact

Otherwise, you risk causing damage or malfunction.



**! WARNING**

**Do not share an outlet with an unreasonable number of other devices**

Otherwise, you risk overheating or fire.



**Do not use overseas**

Before using the unit in overseas, consult with your retailer, the nearest Roland Service Center, or an authorized Roland distributor, as listed on the "Information".



No naked flame sources as lighted candles should be placed on the apparatus.



Use the apparatus in moderate climates.



**! CAUTION**

**Use only the specified stand(s)**

This unit is designed to be used in combination with specific stands (KS-G8B) manufactured by Roland. If used in combination with other stands, you risk sustaining injuries as the result of this product dropping down or toppling over due to a lack of stability.



**Evaluate safety issues before using stands**

Even if you observe the cautions given in the owner's manual, certain types of handling may allow this product to fall from the stand, or cause the stand to overturn. Please be mindful of any safety issues before using this product.



**When disconnecting the power cord, grasp it by the plug**

To prevent conductor damage, always grasp the power cord by its plug when disconnecting it.



**Periodically clean the power plug**

An accumulation of dust or foreign objects between the power plug and the power outlet can lead to fire or electric shock. At regular intervals, be sure to pull out the power plug, and using a dry cloth, wipe away any dust or foreign objects that may have accumulated.



**Disconnect the power plug whenever the unit will not be used for an extended period of time**

Fire may result in the unlikely event that a breakdown occurs.



**Route all power cords and cables in such a way as to prevent them from getting entangled**

Injury could result if someone were to trip on a cable and cause the unit to fall or topple.



**Avoid climbing on top of the unit, or placing heavy objects on it**

Otherwise, you risk injury as the result of the unit toppling over or dropping down.



**! CAUTION**

**Never connect/disconnect a power plug if your hands are wet**

Otherwise, you could receive an electric shock.



**Disconnect all cords/cables before moving the unit**

Before moving the unit, disconnect the power plug from the outlet, and pull out all cords from external devices.



**Before cleaning the unit, disconnect the power plug from the outlet**

If the power plug is not removed from the outlet, you risk receiving an electric shock.



**Whenever there is a threat of lightning, disconnect the power plug from the outlet**

If the power plug is not removed from the outlet, you risk causing malfunction or receiving an electric shock.



**Keep small items out of the reach of children**

To prevent accidental ingestion of the parts listed below, always keep them out of the reach of small children.



- Removable Parts
- USB cap (p. 10)

# IMPORTANT NOTES

## Power Supply

- Do not connect this unit to same electrical outlet that is being used by an electrical appliance that is controlled by an inverter or a motor (such as a refrigerator, washing machine, microwave oven, or air conditioner). Depending on the way in which the electrical appliance is used, power supply noise may cause this unit to malfunction or may produce audible noise. If it is not practical to use a separate electrical outlet, connect a power supply noise filter between this unit and the electrical outlet.

## Placement

- Using the unit near power amplifiers (or other equipment containing large power transformers) may induce hum. To alleviate the problem, change the orientation of this unit; or move it farther away from the source of interference.
- This unit may interfere with radio and television reception. Do not use this unit in the vicinity of such receivers.
- Noise may be produced if wireless communications devices, such as cell phones, are operated in the vicinity of this unit. Such noise could occur when receiving or initiating a call, or while conversing. Should you experience such problems, you should relocate such wireless devices so they are at a greater distance from this unit, or switch them off.
- When moved from one location to another where the temperature and/or humidity is very different, water droplets (condensation) may form inside the unit. Damage or malfunction may result if you attempt to use the unit in this condition. Therefore, before using the unit, you must allow it to stand for several hours, until the condensation has completely evaporated.
- Do not allow objects to remain on top of the keyboard. This can be the cause of malfunction, such as keys ceasing to produce sound.
- Depending on the material and temperature of the surface on which you place the unit, its rubber feet may discolor or mar the surface.
- Do not place containers or anything else containing liquid on top of this unit. Also, whenever any liquid has been spilled on the surface of this unit, be sure to promptly wipe it away using a soft, dry cloth.

## Maintenance

- Never use benzine, thinners, alcohol or solvents of any kind, to avoid the possibility of discoloration and/or deformation.

## Care of the Keyboard

- Do not write on the keyboard with any pen or other implement, and do not stamp or place any marking on the instrument. Ink will seep into the surface lines and become unremovable.
- Do not affix stickers on the keyboard. You may be unable to remove stickers that use strong adhesives, and the adhesive may cause discoloration.
- To remove stubborn dirt, use a commercially available keyboard cleaner that does not contain abrasives. Start by wiping lightly. If the dirt does not come off, wipe using gradually increasing amounts of pressure while taking care not to scratch the keys.

## Repairs and Data

- Before sending the unit away for repairs, be sure to make a backup of the data stored within it; or you may prefer to write down the needed information. Although we will do our utmost to preserve the data stored in your unit when we carry out repairs, in some cases, such as when the memory section is physically damaged, restoration of the stored content may be impossible. Roland assumes no liability concerning the restoration of any stored content that has been lost.

## Additional Precautions

- Any data stored within the unit can be lost as the result of equipment failure, incorrect operation, etc. To protect yourself against the irretrievable loss of data, try to make a habit of creating regular backups of the data you've stored in the unit.
- Roland assumes no liability concerning the restoration of any stored content that has been lost.
- Use a reasonable amount of care when using the unit's buttons, sliders, or other controls; and when using its jacks and connectors. Rough handling can lead to malfunctions.
- Never strike or apply strong pressure to the display.
- When disconnecting all cables, grasp the connector itself—never pull on the cable. This way you will avoid causing shorts, or damage to the cable's internal elements.
- A small amount of heat will radiate from the unit during normal operation.
- To avoid disturbing others nearby, try to keep the unit's volume at reasonable levels.
- The sound of keys being struck and vibrations produced by playing an instrument can be transmitted through a floor or wall to an unexpected extent. Please take care not to cause annoyance to others nearby.
- Use only the specified expression pedal. By connecting any other expression pedals, you risk causing malfunction and/or damage to the unit.
- Do not use connection cables that contain a built-in resistor.

## Using External Memories

- Please observe the following precautions when handling external memory devices. Also, make sure to carefully observe all the precautions that were supplied with the external memory device.
  - Do not remove the device while reading/writing is in progress.
  - To prevent damage from static electricity, discharge all static electricity from your person before handling the device.

## Intellectual Property Right

- It is forbidden by law to make an audio recording, video recording, copy or revision of a third party's copyrighted work (musical work, video work, broadcast, live performance, or other work), whether in whole or in part, and distribute, sell, lease, perform or broadcast it without the permission of the copyright owner.
- Do not use this product for purposes that could infringe on a copyright held by a third party. We assume no responsibility whatsoever with regard to any infringements of third-party copyrights arising through your use of this product.
- The copyright of content in this product (the sound waveform data, style data, accompaniment patterns, phrase data, audio loops and image data) is reserved by Roland Corporation.
- Purchasers of this product are permitted to utilize said content (except song data such as Demo Songs) for the creating, performing, recording and distributing original musical works.
- Purchasers of this product are NOT permitted to extract said content in original or modified form, for the purpose of distributing recorded medium of said content or making them available on a computer network.
- MMP (Moore Microprocessor Portfolio) refers to a patent portfolio concerned with microprocessor architecture, which was developed by Technology Properties Limited (TPL). Roland has licensed this technology from the TPL Group.
- ASIO is a trademark and software of Steinberg Media Technologies GmbH.
- This product contains eParts integrated software platform of eSQL Co., Ltd. eParts is a trademark of eSQL Co., Ltd. in Japan.
- This Product uses the Source Code of  $\mu$ T-Kernel under T-License 2.0 granted by the T-Engine Forum ([www.tron.org](http://www.tron.org)).
- Roland, SuperNATURAL are either registered trademarks or trademarks of Roland Corporation in the United States and/or other countries.
- Company names and product names appearing in this document are registered trademarks or trademarks of their respective owners.

# Contents

<b>USING THE UNIT SAFELY</b> .....	<b>2</b>	<b>Various Settings</b> .....	<b>26</b>
<b>IMPORTANT NOTES</b> .....	<b>4</b>	Accessing the Menu Screens .....	26
<b>Placing the RD-2000 on a Stand</b> .....	<b>6</b>	Setting Parameters (System) .....	26
<b>Main Specifications</b> .....	<b>6</b>	Formatting Memory (Format) .....	26
<b>Basic Operation</b> .....	<b>7</b>	Returning to the Factory Settings (Factory Reset) .....	27
<b>Panel Descriptions</b> .....	<b>8</b>	Making the Power Automatically Turn Off After a Time (Auto Off) .....	27
Top Panel .....	8	Listening to the Demo Songs .....	27
Rear Panel (Connecting the External Equipment) .....	10	Backing Up RD-2000 Data to a USB Flash Drive (Backup Save) ..	27
Turning the RD-2000 On .....	11	Restoring Backup Data from a USB Flash Drive to the RD-2000 (Backup Load) .....	27
Turning Off the Power .....	11	<b>List of Shortcut Keys</b> .....	<b>28</b>
If you don't want the power to turn off automatically, change the "Auto Off" setting to "Off" .....	11		
<b>Overview of the RD-2000</b> .....	<b>12</b>		
Basic Organization of the RD-2000 .....	12		
About Memory .....	12		
Units of Sound .....	13		
<b>Operation Guide</b> .....	<b>14</b>		
Adjusting the Overall Volume .....	14		
Adjusting the Volume of Each Zone .....	14		
Using an Assigned Function to Modify the Sound (MOD WHEEL 1/2) .....	14		
Changing the Sound's Pitch in Real Time (Pitch bend lever) ...	14		
Adding Vibrato or Dynamics (Modulation lever) .....	14		
Disabling the Button (Panel Lock) .....	14		
Transposing Your Performance (Transpose) .....	14		
Selecting Sounds (TONE/SCENE/PROGRAM) .....	14		
Layering Tones .....	15		
Dividing the Keyboard into Two Regions (Split) .....	15		
Adding Reverberation to the Sound (REVERB) .....	16		
Adding Delay to the Sound (DELAY) .....	16		
Applying an Effect (MODULATION FX) .....	16		
Applying Tremolo (TREMOLLO) .....	16		
Adjusting the Distortion (AMP SIM) .....	17		
Switching the Tremolo Type and the AMP SIM Type .....	17		
Adjusting the Levels of Each Frequency Range (EQUALIZER) ..	17		
Controlling the Functions Assigned to the Knobs (ASSIGN) ...	17		
Performing Live with a Plug-in Synthesizer .....	18		
Using USB Audio .....	19		
Using SUB OUT .....	19		
<b>Editing the Sound</b> .....	<b>20</b>		
Adjusting the Character of the Sound (TONE COLOR) .....	20		
Using the Knobs to Adjust the Sound .....	20		
Editing a Program (Program Edit) .....	21		
Editing a Tone (Designer) .....	21		
Creating the Organ Tones .....	22		
Viewing the State of Each Zone (Zone Info Screen) .....	22		
Saving the Sound Settings in a Program (Program Write) .....	23		
Changing the Order of Programs (Program Swap) .....	23		
<b>Using the Convenient Functions in Performances</b> .....	<b>24</b>		
Playing Rhythm .....	24		
Recording Audio .....	24		
Playing Audio Files from USB Flash Drive .....	25		

English

日本語

Deutsch

Français

Italiano

Español

Português

Nederlands

# Placing the RD-2000 on a Stand

If you want to place the RD-2000 on a stand, use the Roland KS-G8B.  
Place the instrument on the stand as follows.

- \* Be careful not to pinch your fingers when setting up the stand.

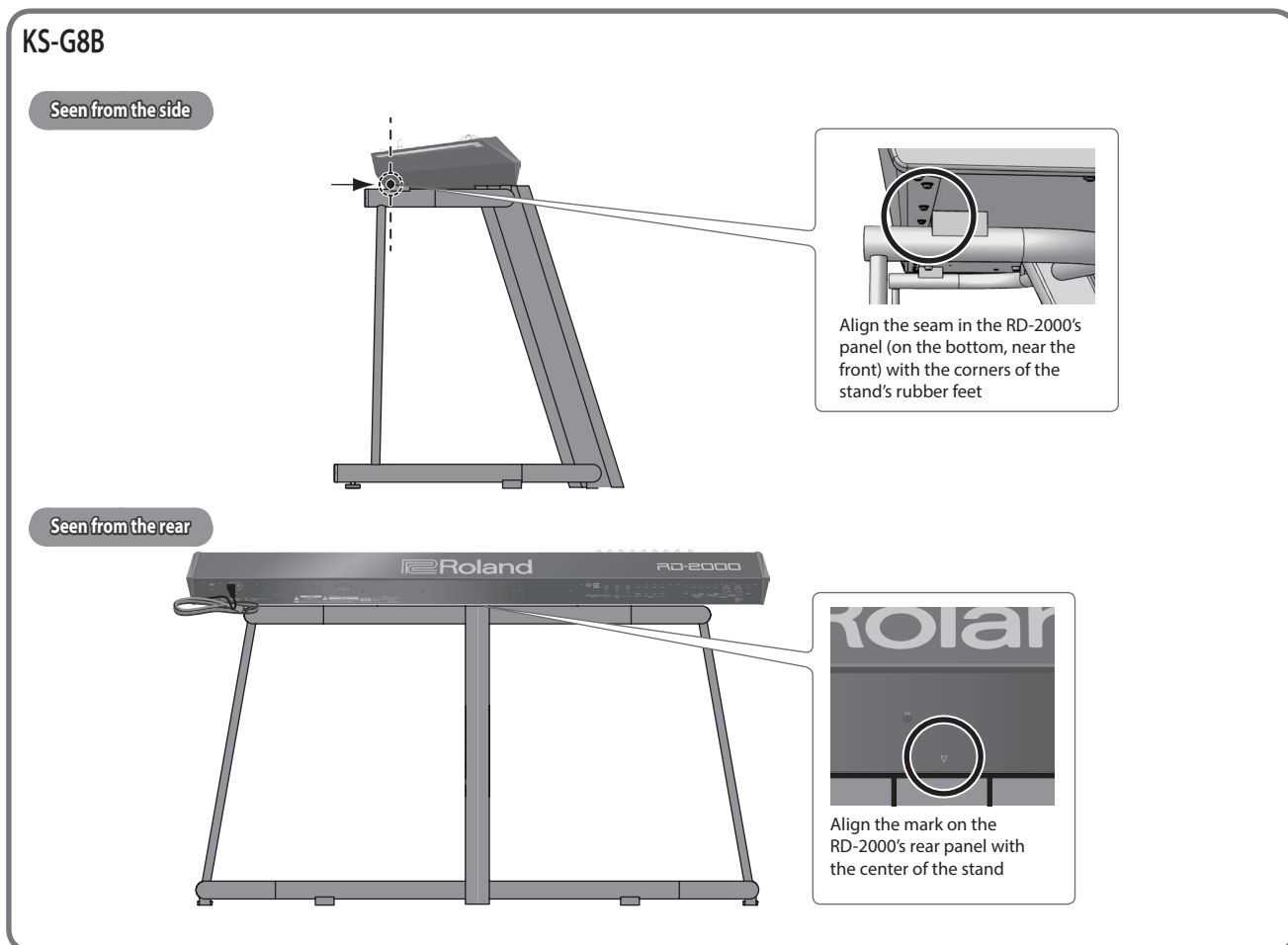

# Main Specifications

## Roland RD-2000: Digital Piano

<b>Keyboard</b>	88 keys (PHA-50)
<b>Power Consumption</b>	23W
<b>Dimensions</b>	1,412 (W) x 367 (D) x 140 (H) mm 55-5/8 (W) x 14-1/2 (D) x 5-9/16 (H) inches
<b>Weight</b>	21.7 kg/47 lbs 14 oz * Actual weight can vary slightly from that indicated due to the fact that wooden parts are involved.
<b>Accessories</b>	Owner's Manual Power Cord Damper pedal (capable of continuous detection)
<b>Options</b>	Keyboard stand: KS-G8B Piano pedal: RPU-3 Damper pedal: DP-10 Pedal switch: DP-2 Expression pedal: EV-5 USB flash drive (*) * Use a commercially available USB flash drive or a USB flash drive sold by Roland. However, we cannot guarantee that all commercially available USB flash drives will work with this unit.

\* This document explains the specifications of the product at the time that the document was issued. For the latest information, refer to the Roland website.



# Basic Operation

## MENU screen

Here you can make system settings for the RD-2000 or manage files.



## TONE screen

This is the screen that appears when you start up the RD-2000 or when you press a TONE button.



This is the screen when zones are layered.



## PROGRAM screen

This is the screen that appears when you press a PROGRAM button.



## SCENE screen



## Navigating among items to be set (cursor)

When more than one parameter is present in a screen, the name and value of the parameter to be changed is shown with a box around it. This box is referred to as the "cursor". The cursor is moved with the Cursor [▲] [▼] [◀] [▶] buttons.



## Knob and slider operations

When you use a knob or slider to modify a setting, the modified parameter and its value appears in a popup screen. This screen will automatically close after a time.

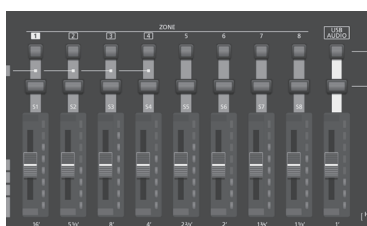

For some parameters, a popup screen does not appear.

## Editing a value

When changing settings values, you can use the [DEC] and [INC] buttons, value dial, or the TONE buttons (numeric keys).



## [DEC] button, [INC] button

Pressing the [INC] button increases the value, and the [DEC] button decreases it.

Purpose	Operation
To continuously change the value	Hold down the [DEC] button or [INC] button.
To rapidly change the value	Hold down the [INC] button and press the [DEC] button. Hold down the [DEC] button and press the [INC] button.
To set the item to its default value	Press the [DEC] button and [INC] button simultaneously.

## Value dial

Turn the dial clockwise to increase the value, or counterclockwise to decrease the value.

## TONE buttons ( numeric keys)



For some of the items, you can use the TONE buttons ([0]–[9]) as numeric keys to directly specify a numeric value.

To use these as numeric keys in the TONE / PROGRAM / SCENE / ZONE EDIT screen, operate the buttons while holding down the [SHIFT] button. When you use the numeric keys to enter a value, the value in the screen blinks. The blinking means that the value is not yet confirmed, so press the [ENTER] button to confirm the value.

## Confirming or canceling the value

To confirm the specified value, press the [ENTER] button. If you decide to cancel, press the [EXIT] button.



# Panel Descriptions

## Top Panel

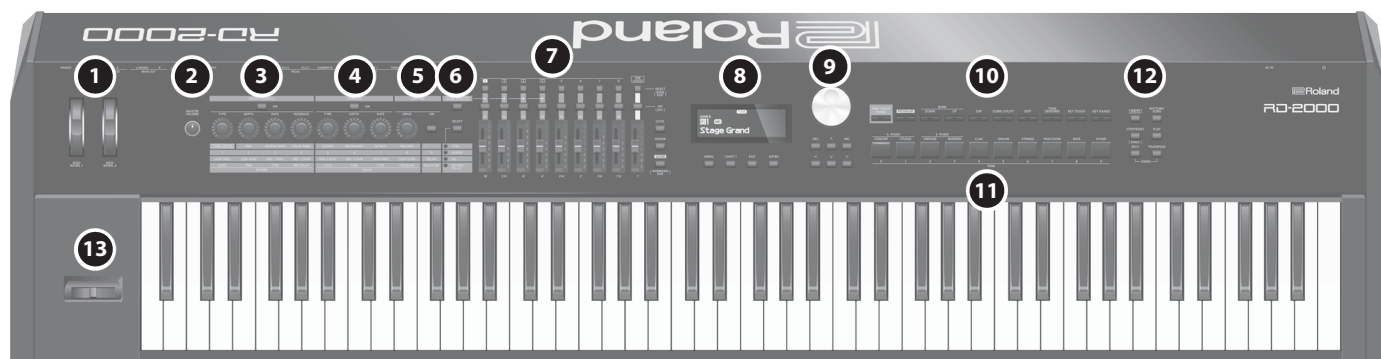

### 1 MOD WHEEL 1/2

You can assign various functions to these wheels. You can use the assigned functions by moving these wheels while you perform.

### 2 [MASTER VOLUME] knob

Adjusts the overall volume of the RD-2000.

### 3 MODULATION FX

#### [ON] button

Turns the effect on/off.

#### [TYPE] knob

Selects the type of the modulation FX.

#### [DEPTH] knob

Adjusts the depth of the modulation FX.

#### [RATE] knob

Adjusts the rate of the modulation FX.

#### [FEEDBACK] knob

Adjusts the amount of feedback for the modulation FX.

### 4 TREMOLO

#### [ON] button

Turns the effect on/off.

#### [TYPE] knob

Selects the type of tremolo.

#### [DEPTH] knob

Adjusts the depth of the tremolo effect.

#### [RATE] knob

Adjusts the rate of the tremolo effect.

### 5 AMP SIM

#### [DRIVE] knob

Adjusts the amount of distortion.

#### [ON] button

Turns the effect on/off.

### 6 [ZONE EFFECTS] button

Turns the ZONE EFFECT on/off.

If ZONE EFFECT is on, the MODULATION FX, TREMOLO, and AMP SIM knobs and buttons operate as controllers for each function.

If this button is off, the knobs and buttons operate as controllers for the function that is selected by the [SELECT] knob.

#### [SELECT] button

Selects the function that the knobs and buttons will have when ZONE EFFECT is off. The function changes each time you press the button.

#### CTRL, ASSIGN, EQ, REVERB/DELAY indicator

Indicate the function that is selected by the [SELECT] button.

### 7 ZONE

#### SELECT buttons (1–8, USB-AUDIO)

Select the zone to control.

By holding down the [SHIFT] button and pressing one of these buttons, you can access the ZONE EDIT screen of each zone.

#### INT/EXT select buttons (1–8, USB-AUDIO)

Turns each ZONE's sound on and off.

Select whether the knobs and slider operate the RD-2000 itself or an external MIDI sound module.

#### Sliders (S1–S8, USB-AUDIO)

Use these sliders to adjust the volume of each zone, or to edit values.

#### [LEVEL] button

If you press this button to make it light, you can use the sliders to adjust the volume of each zone.

#### [ASSIGN] button

If you press this button to make it light, you can adjust the value that is assigned to the sliders.

#### [SCENE] button

If you press this button to make it light, you can use the TONE buttons to recall scenes.

If a TW organ sound is selected for the zone that is selected by the SELECT button, you can hold down the [SHIFT] button and press this button, and then use the sliders to modify the sound as when using the harmonic bars of a tonewheel organ.



8

### Display

This shows the Tone name, the Program names and the values of various settings, etc.

### [MENU] button

Accesses the MENU screen. In the MENU screen, you can make overall settings for the entire RD-2000.

### [SHIFT] button

You can easily call up Edit screens for related parameters by holding down this button while pressing buttons, turning knobs, or operating other controllers. For details, refer to "List of Shortcut Keys" (p. 28). If you edit a parameter value while holding down this button, the value will change more greatly.

### [EXIT] button

This is used to return to a previous screen or to cancel a procedure.

### [ENTER] button

This is used to finalize a value or execute an operation.

## 9 Cursor buttons/Value dial

### Value dial

These are used to modify values.

### [DEC] button, [INC] button

These are used to modify values.

If you keep on holding down one button while pressing the other, the value change accelerates.

These buttons modify the value that's controlled by the value dial.

### Cursor [◀] [▶] [▲] [▼] buttons

Press these to switch pages and to move the cursor.

10

### [ONE TOUCH PIANO] button

Recalls a piano sound to zone 1. Zones other than zone 1 and zone 5 (EXT) are turned off.

You can also specify a favorite sound (STARTUP).

#### NOTE

Be aware that when you press this button to recall a piano sound, the previous settings are lost.

### [PROGRAM] button

Selects a program.

### BANK [UP] [DOWN] buttons

Change the program or scene bank.

### [EXP] button

Selects banks of expansion sounds (p. 15).

### [SCENE UTILITY] button

Accesses the SCENE UTILITY MENU screen.

### [EDIT] button

Allows you to edit program settings.

### [TONE DESIGNER] button

Accesses the TONE DESIGNER screen.

### [KEY TOUCH] button

Adjusts the key touch.

### [KEY RANGE] button

Specifies the key range.

## 11 TONE buttons

Select tones in each category.

12

### [WRITE] button

Stores the current settings in a program.

If you press this button in certain screens (such as the System screen), system parameters (p. 26) are stored.

### [STOP/RESET] button

Stops playback of the song or rhythm.

### [RHYTHM/SONG] button

Accesses a screen where you can select songs or rhythms.

### [PLAY] button

Starts playback of the song or rhythm.

### [SPLIT] button

Turns the split function on/off.

This lets you divide the keyboard into left and right regions and play a different sound in each.

By pressing this button and the [TRANSCOPE] button simultaneously, you can listen to demo songs.

### [TRANSCOPE] button

Lets you transpose your performance.

## 13 Pitch bend/Modulation lever

This allows you to control pitch bend or apply vibrato.

#### NOTE

The effect of moving the lever will differ depending on the tone. The effect of this lever is fixed for each tone, and cannot be changed.

## Rear Panel (Connecting the External Equipment)

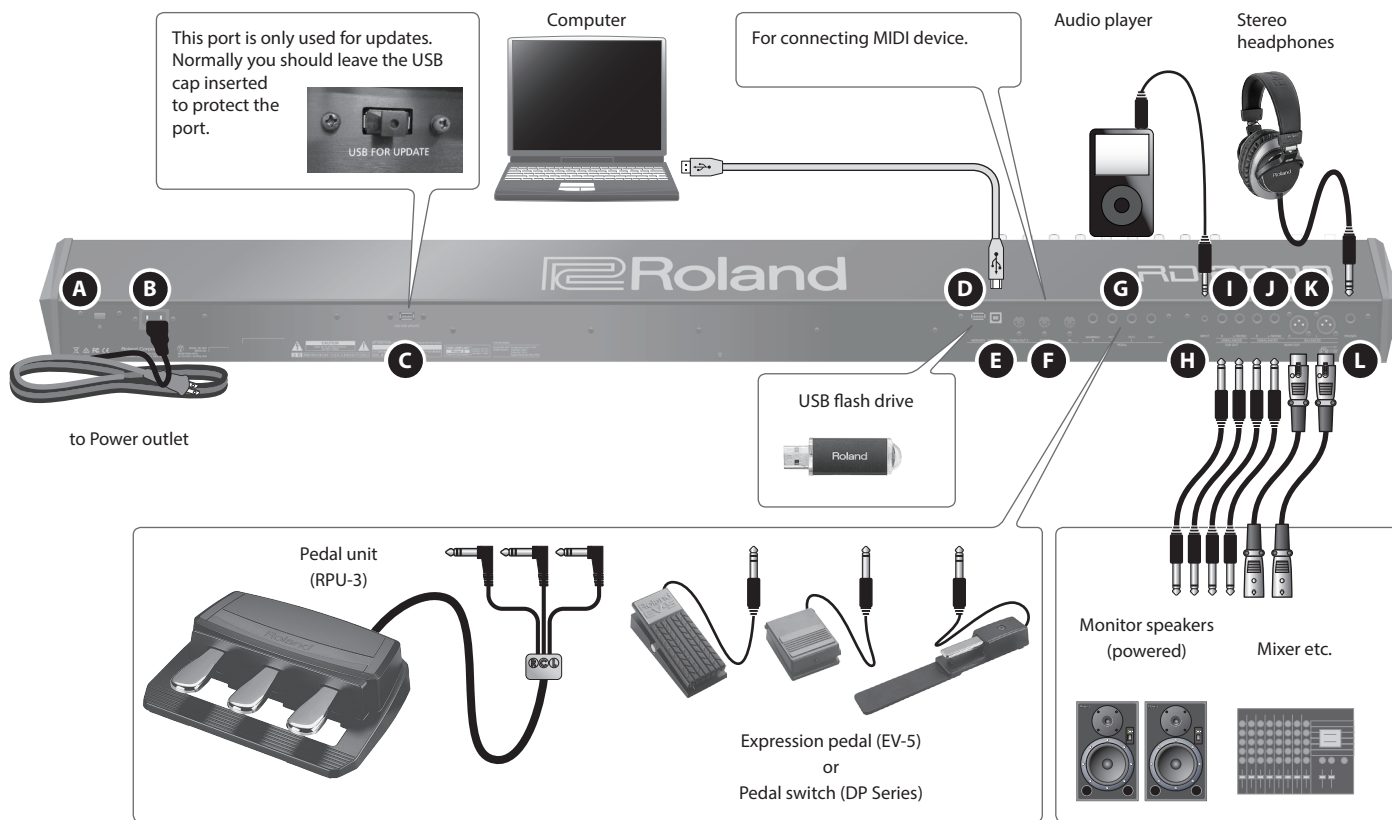

### A [ON/OFF] switch

This turns the power on/off.

page 11

### B AC IN jack

Connect the included power cord to this connector.

- \* To prevent malfunction and equipment failure, always turn down the volume, and turn off all the units before making any connections.
- \* Use only the specified expression pedal. By connecting any other expression pedals, you risk causing malfunction and/or damage to the unit.

### C USB FOR UPDATE jack

Use this to update the RD-2000.

Normally you should leave the USB cap inserted to protect the port.

### D USB MEMORY port

Use a commercially available USB flash drive or a USB flash drive sold by Roland. However, we cannot guarantee that all commercially available USB flash drives will work with this unit.

### E USB COMPUTER port

You can connect this to your computer so that it can exchange performance data and audio signal with the RD-2000.

page 18

### F MIDI connectors (IN, OUT 1, THRU/OUT 2)

Used for connecting external MIDI devices and for transmission of MIDI messages.

The THRU/OUT 2 connector's function can be switched to operate either as MIDI THRU or as MIDI OUT (p. 26).

### G PEDAL jack (DAMPER, FC1, FC2, EXT)

Connecting the pedal switch provided with the RD-2000 to the DAMPER jack allows you to use the switch as a damper pedal.

With a pedal connected to the FC1, FC2 or EXT jack, you can then assign a variety of functions to the pedal (p. 21).

### H INPUT jack

This is an audio input jack. You can connect your audio player or other audio source here.

### I SUB OUT jack (L/MONO, R)

Provide output of the audio signals. For mono output, use the L/MONO jack.

page 19

### J MAIN OUT jack (L/MONO, R)

These are connected to an amp or other device. For mono output, use the L/MONO jack.

### K MAIN OUT jack (L, R) (XLR type)

Connectors for balanced output of the audio signals. Connect to mixers and other such gear.

- \* Pin assignment of MAIN OUT jack

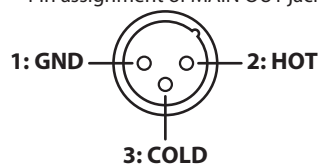

### L PHONES jack

A set of headphones can be connected to this jack.

Even when headphones are connected, audio signals will still be output from the OUTPUT jacks and BALANCED OUT jacks.

## Turning the RD-2000 On

Once everything is properly connected, be sure to follow the procedure below to turn on their power. If you turn on equipment in the wrong order, you risk causing malfunction or equipment failure.

### 1. Turn down the volume of the RD-2000.

Also completely turn down the volume of any connected external devices.

### 2. Press the [⏻] switch.

The unit is turned on, and the display's backlighting comes on.

### 3. Turn on the power to connected external devices.

### 4. Adjust the volume of the connected external devices.

### 5. Adjust the RD-2000's volume.

## Turning Off the Power

### 1. Turn down the volume of the RD-2000.

Also completely turn down the volume of any connected external devices.

### 2. Turn off the power to connected external devices.

### 3. Press the [⏻] switch.

The unit is turned off.

- \* Before turning the unit on/off, always be sure to turn the volume down. Even with the volume turned down, you might hear some sound when switching the unit on/off. However, this is normal and does not indicate a malfunction.
- \* If you need to turn off the power completely, first turn off the unit, then unplug the power cord from the power outlet. Refer to **"To completely turn off power to the unit, pull out the plug from the outlet"** (p. 2).

## If you don't want the power to turn off automatically, change the "Auto Off" setting to "Off"

The power to this unit will be turned off automatically after a predetermined amount of time has passed since it was last used for playing music, or its buttons or controls were operated (Auto Off function).

If you do not want the power to be turned off automatically, disengage the Auto Off function.

### NOTE

- When the power is turned off, any settings you were editing will be lost. You must save settings that you want to keep.
- To restore power, turn the power on again.

### Changing the auto off setting

#### 1. In the MENU screen, select "SYSTEM" and press the [ENTER] button.

The System screen appears.

#### 2. Choose "Auto Off", and change the setting.

Parameter [◀] [▶]	Value [DEC] [INC]	Explanation
Auto Off	Off	The power will not turn off automatically.
	30 min	The power will automatically turn off if no operation is performed for 30 minutes.
	240 min (default)	The power will automatically turn off if no operation is performed for 240 minutes (four hours).

#### 3. To store the auto off setting, press the [WRITE] button in the System screen.

### NOTE

When the auto off function turns the power off, the settings that you were editing will be lost. If there are settings that you want to keep, you should save them beforehand. For details, refer to "Saving the Sound Settings in a Program (Program Write)" (p. 23) and "Saving the system settings" (p. 26).

### To Turn the Power On Again After It Was Turned Off by "Auto-Off"

If the auto off function turned the power off, turn off the [⏻] switch and then turn the power on again.

# Overview of the RD-2000

## Basic Organization of the RD-2000

### Controller Section

This section includes the keyboard, the Pitch Bend/Modulation lever, the panel knobs, the sliders, and any pedal connected to the rear panel. Actions such as pressing and releasing of keys on the keyboard, depressing a damper pedal, and so forth, are converted to MIDI messages and sent to the sound generator section, or to an external MIDI device.

### Sound generator/Effect section

This is the section that produces and modifies the sound. Performance data from the controller section is converted into audio signal, which is output from the OUTPUT jacks or PHONES jack.

#### V-Piano Technology sound generator (only zone 1 can be selected) (MD)

For sounds beginning with S01, this sound generator reproduces the sound of a piano based on its structure.

#### NOTE

This sound generator does not support Modulation FX, Tremolo/Amp Sim, or Tone/Program Remain.

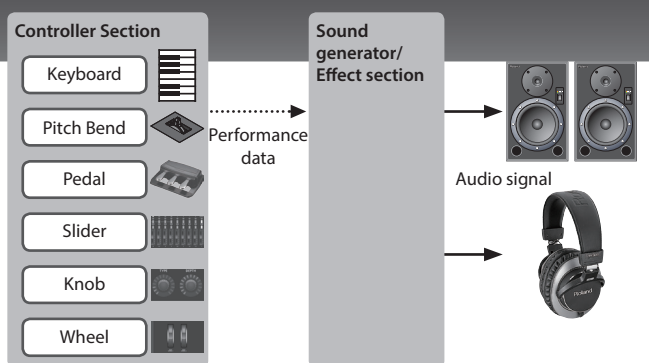

#### SuperNATURAL (SN)/PCM sound generator

This sound generator lets you play a variety of high-quality sounds, including SuperNATURAL sounds that faithfully reproduce the character and behavior of musical instruments. The RD-2000 contains more than a thousand sounds.

#### Effects

Each zone 1–4 provides a Modulation FX and Tremolo/Amp Sim that can be set independently for each zone. There are also reverb, delay, and EQ that can be used in common by all zones.

## About Memory

“Memories” are locations where settings such as programs are stored. There are three types of memory: “temporary memory”, “rewritable memory”, and “non-rewritable memory”.

### Temporary Memory

#### Temporary area

The tones, programs, scenes, or controller settings that you select using the panel TONE buttons or PROGRAM button are recalled into the temporary area. When you play the keyboard, sounds are produced according to the settings that are in the temporary area. The settings in the temporary area will be lost when you turn off the power or call up other settings. If you want to keep the data that’s in the temporary area, you must store it into rewritable memory.

### Rewritable Memory

#### System memory

System memory contains system parameter settings that specify how the RD-2000 is to operate. To store system parameters, save the system settings (p. 26).

#### User memory

Programs and scenes can be stored in user memory (Program Write: p. 23).

#### USB flash drive

You can save all of the programs in a single file (Backup Save: p. 27). The USB flash drive is also used as the storage location for audio recording.

### Non-rewritable Memory

#### Preset memory

The demo songs and the tones are stored in preset memory; they cannot be rewritten.

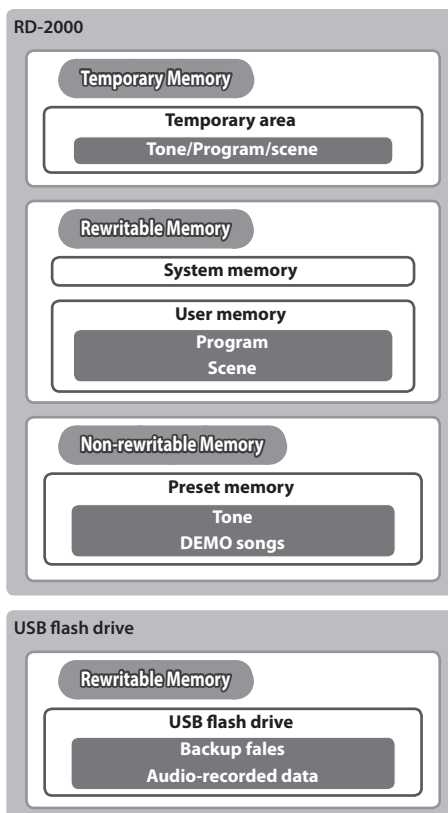

## Units of Sound

### Tone

Tones are an ideal way to select and play a sound.

The sounds that you select using the TONE buttons are called "tones". Tones can be assigned to each of the eight **zones (zone 1–8)** and played. You can play multiple zones simultaneously from the keyboard, or play them in separate regions of the keyboard. You can use the Designer function (p. 21) to edit a tone to your taste. You can store an edited tone in a program. Some of the tones are "rhythm sets" which contain multiple percussion instrument sounds. A rhythm set will produce a different percussion instrument sound for each key (note number) that you press.

### Program

Programs let you store a combination of settings and multiple sounds.

The sounds that you select using the PROGRAM button are called "programs". Programs contain settings for the tones that are assigned to the zones, along with settings that are common to all zones (such as reverb, delay, and EQ). You can store 300 programs containing settings that you've edited to your taste.

### Scene

Scenes are an ideal way to store and order favorite tones or programs, or when using an external MIDI device.

The sounds that you select using the SCENE button are called "scenes". Scenes let you store performance settings that you've edited to your taste. Up to 100 scenes that you save can be recalled from the TONE buttons, with ten scenes for each button. You can use scenes to easily recall settings in the order of the songs in your live performance, or to control or set up an external device. It's also easy to store tones or programs without change, modify their sound or settings, or change the order in which they are recalled.

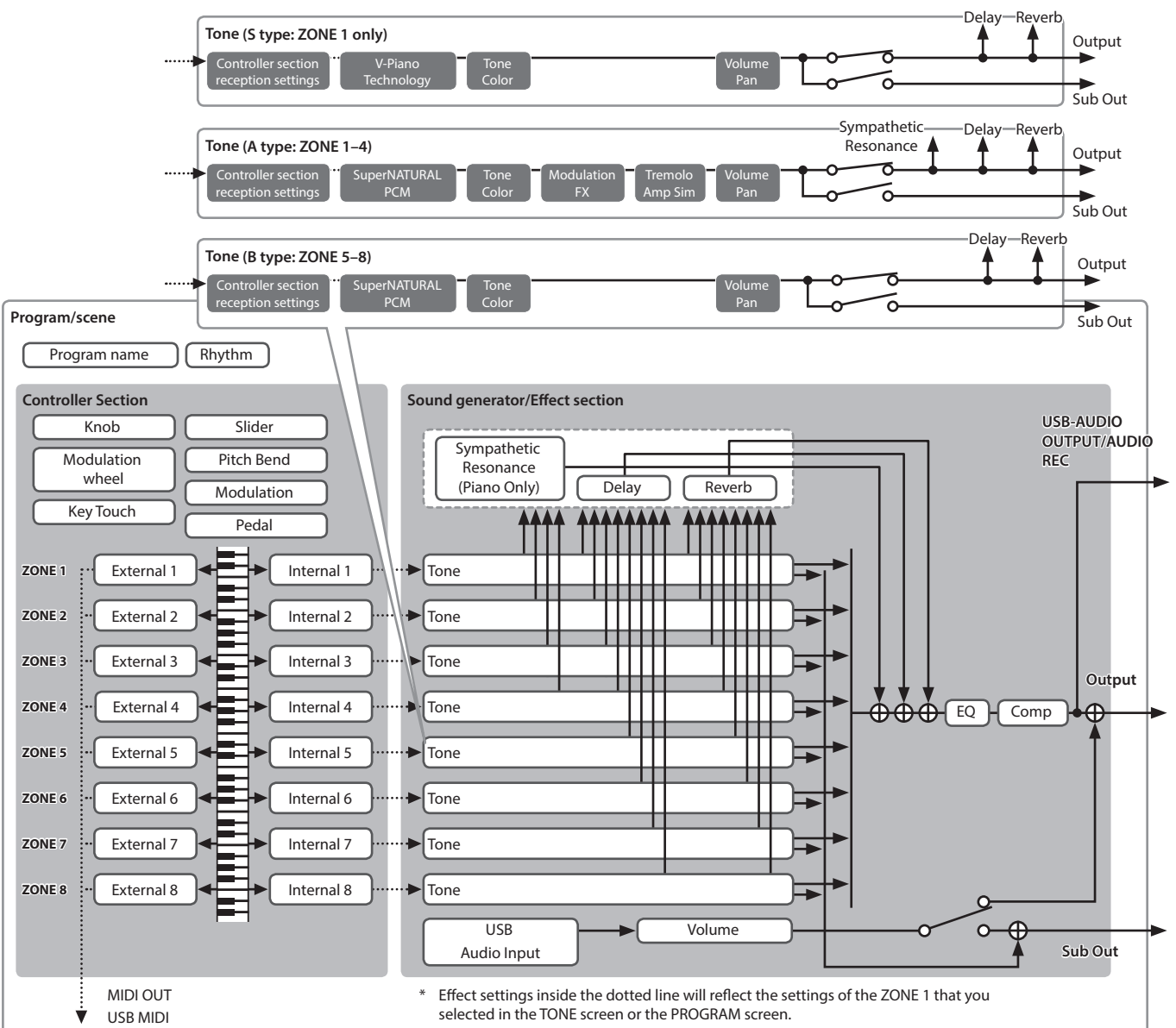

# Operation Guide

## Adjusting the Overall Volume

1. Turn the [MASTER VOLUME] knob.

## Adjusting the Volume of Each Zone

### Selecting the zone to adjust

Select the zone whose settings you want to adjust.

1. Press one of the SELECT [S1]–[S8] buttons.

### MEMO

You can't select multiple zones.

### Turning each zone on/off

1. Press the INT/EXT [S1]–[S8] buttons to turn each zone on (lit) or off (unlit).

### MEMO

By holding down the [SHIFT] button and pressing an INT/EXT [S1]–[S8] button, you can switch what the knob and slider of each zone will control (the RD-2000: lit red, or an external device: lit green).

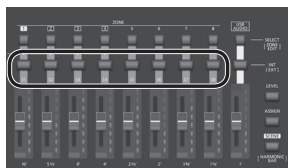

### NOTE

Effects cannot be applied to zones 5–8. If zones 5–8 are also assigned as internal zones, and if an extremely large amount of data is being produced by the controllers, a substantial burden is placed on the RD-2000, possibly making it unable to process the performance data from the keyboard.

### Adjusting the volume of each zone

1. Use the sliders [S1]–[S8] to adjust the volume of each zone.

## Using an Assigned Function to Modify the Sound (MOD WHEEL 1/2)

A variety of functions are assigned to the modulation wheels (p. 21). By moving the modulation wheels while you perform, you can control the assigned function.

## Changing the Sound's Pitch in Real Time (Pitch bend lever)

While playing the keyboard, move the lever to the left to lower the pitch, or to the right to raise the pitch. This is known as Pitch Bend.



If you move the lever away from yourself while also moving it to left or right, the pitch bend and modulation effects will be applied simultaneously.

## Adding Vibrato or Dynamics (Modulation lever)

You can also apply vibrato by manipulating the lever away from you. This is known as Modulation.



If you move the lever away from yourself while also moving it to left or right, the pitch bend and modulation effects will be applied simultaneously.

## Disabling the Button (Panel Lock)

By engaging the Panel Lock function, you can disable panel functions. This prevents settings from being changed inadvertently on stage or in other such situations.

1. Hold down the [MENU] button and press the [ENTER] button. The panel lock popup screen appears for a time and then disappears; then an icon indicating the panel lock status appears in the upper

right of the TONE screen and the PROGRAM screen or the upper left of the SCENE screen.

2. To disengage the Panel Lock function, press the [EXIT] button twice in succession.

## Transposing Your Performance (Transpose)

You can adjust the transpose setting in semitone steps over a range of -48–0–+48 relative to C4.

1. Hold down the [TRANSCOPE] button for several seconds. The current setting is shown.



2. Hold down the [TRANSCOPE] button and use the [DEC][INC] buttons or the keyboard to specify the amount of transposition. When you release the [TRANSCOPE] button, the previous screen reappears.

When the amount of transposition is set, the Transpose function switches on, and the [TRANSCOPE] button lights up.

### MEMO

- If you press the C4 (middle C) key, the transpose amount will be set to "0". For example, to have "E" sound when you play "C" on the keyboard, hold down the [TRANSCOPE] button and press the E4 key. The degree of transposition then becomes "+4".
- You can set the degree of transposition for each of the Layer individually. For details, refer to "Parameter Guide (English)" (PDF).

### NOTE

If the transpose amount is 0, the [TRANSCOPE] button will not turn on even if you press it.

## Selecting Sounds (TONE/SCENE/PROGRAM)

### Selecting a tone

1. Make the [SCENE] button go dark. Or, press the [One Touch Piano] button.
2. Press a SELECT [S1]–[S8] button to select the zone for which you want to select a sound.
3. Press any of the TONE buttons to select the category.

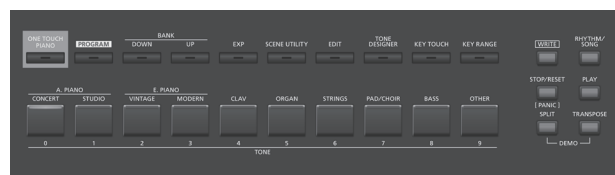

4. Use the [DEC] [INC] buttons or value dial to select the tone.

### MEMO

- By holding down the [SHIFT] button and using the [INC] [DEC] buttons or the value dial, you can select the first sound of each tone category.
- Sounds beginning with S01 are only for zone 1. These piano sounds cannot be selected for zones 2–8.

### Using the Numeric Keys to Select Tones

1. While holding down the [SHIFT] button, use the [0]–[9] to enter a tone number. The value blinks while you're entering the tone number.



## 2. Release the [SHIFT] button.

The tone number is finalized.

### MEMO

To enter an S sound, hold down the [SHIFT] button and press the [ONE TOUCH PIANO] button. To enter EXP A/B, hold down the [SHIFT] button and press the [EXP] button.

### Selecting the EXP category

#### [EXP] button

This is a bank for expansion sounds.

To switch between A/B, press the [EXP] button.

The wide variety of tones available from the Axial sound library site can be added to the RD-2000.

For details, refer to the Axial site.

➔ <http://axial.roland.com/>



#### Selecting a program

The RD-2000 has 15 banks, A–O, and each bank lets you store 20 programs (for a total of 300).

1. Press the [PROGRAM] button to make it light.
2. Use the BANK [UP] [DOWN] buttons to select the program bank (A–O).
3. Use the [DEC] [INC] buttons or value dial to select the program number.

### Using the Numeric Keys to Select Programs

1. Use the BANK [UP] [DOWN] buttons to select the program bank (A–O).
2. While holding down the [SHIFT] button, use the [0]–[9] to enter a program number.  
The value blinks while you're entering the program number.
3. Release the [SHIFT] button.  
The program number is finalized.

#### Registering a scene

1. Select the settings and the program or tone that you want to register in the scene.
2. Hold down the [SCENE] button and use the BANK [UP] [DOWN] buttons to select the desired registration-destination program bank, and then press one of the TONE buttons.  
The currently selected tone or program together with the performance status are registered.

Lit button	A scene is already registered.
Blinking button	A scene is not registered.

The currently selected scene can also be registered in another button, or you can modify the settings and overwrite them.

#### Recalling a scene

You can store up to 100 settings, such as for frequently used programs. One setting can be stored in each TONE button. Ten settings can be registered in each bank for instant recall.

1. Press the [SCENE] button to make it light.
2. To select a scene (0–9), press any TONE button that is lit.

### MEMO

Pressing an unlit TONE button won't select anything.

## Layering Tones

According to the order in which you press the TONE buttons, you can layer up to four zones ZONE (only zones 1–4).

1. Press two, three, or four TONE buttons together in the desired order.

### NOTE

If the previous sound has been edited, the result of your editing is lost when you execute this operation. If you want to keep the sound, save it before you proceed.

#### Changing a zone's tone

1. Press a SELECT [S1]–[S8] button to select a zone.  
The cursor moves to the tone number of the selected zone.
2. Select a tone as described in "Selecting a tone" (p. 14).

## Dividing the Keyboard into Two Regions (Split)

1. Press the [SPLIT] button to make it light.  
The zone 1 tone sounds in the right-hand region of the keyboard, and the zone 4 tone sounds in the left-hand region.

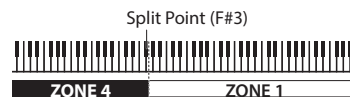

2. To exit Split mode, press the [SPLIT] button once more to make it unlit.

#### Changing the Keyboard's Split Point

1. While holding down the [SPLIT] button, press the key that is to become the new split point.  
The split point is shown.  
When you release the [SPLIT] button, the previous display will reappear.  
The split-point key is included in the ZONE 4 section.

#### Changing the tone of zone 4

1. Press the SELECT [S4] button to select zone 4.
2. Select a tone as described in "Selecting a tone" (p. 14).

### MEMO

By using the key range function, you can freely specify the key range of each zone.

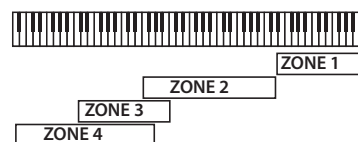

#### Changing the settings of each zone

Here's how to turn each zone on or off.

1. Press the button several times until the INT/EXT button goes dark.  
The zone turns off.
2. If you press the INT/EXT button once again.  
The INT/EXT button lights and the zone turns on.  
Now you can use the indicated function.

## Adding Reverberation to the Sound (REVERB)

Applying reverb adds pleasing reverberation to what you play, so it sounds almost as if you were playing in a concert hall.



1. Press the ZONE EFFECTS [SELECT] button several times, to select the "REVERB/DELAY".
2. Turn the REVERB [TYPE] knob, to select the reverb type.
3. Turn the REVERB [LEVEL], [TIME] and [PRE DELAY] knobs to adjust the amount of reverb effect to be applied.

### MEMO

- If you use the ZONE EFFECTS [SELECT] button to select "CTRL", the [REV SEND] knob can adjust the reverb send level. If this value is "0", turning the REVERB [LEVEL]–[PRE DELAY] knobs has no effect.
  - ➔ REV (Reverb Send Level) in the zone settings (ZONE EDIT)
- If you hold down the [SHIFT] button and turn the REVERB [LEVEL]–[PRE DELAY] knobs, the Reverb screen appears. In the Reverb screen, you can edit the reverb type and other reverb-related parameters.

## Adding Delay to the Sound (DELAY)

By adding the delay effect, you can give the sound greater dimension, with more fatness and breadth.



1. Press the ZONE EFFECTS [SELECT] button several times, to select the "REVERB/DELAY".
2. Press the [DELAY ON] button to make the indicator light. The delay effect will turn on/off each time you press the button.
3. Turn the DELAY [TYPE] knob, to select the delay type.
4. Turn the DELAY [LEVEL], [TIME] and [FEEDBACK] knobs to adjust the character of the delay effect.

### MEMO

If you use the ZONE EFFECTS [SELECT] button to select "CTRL", the [DLY SEND] knob can adjust the delay send level. If this value is "0", turning the DELAY [LEVEL]–[FEEDBACK] knobs has no effect.
 

- ➔ "DLY (Delay Send Level)" in the zone settings (ZONE EDIT)

## Applying an Effect (MODULATION FX)

In the MODULATION FX section you can apply a variety of effects such as modulation-type effects to zones 1–4.



### MEMO

Effects cannot be applied to zones 5–8.

1. Press the [ZONE EFFECTS] button to make the indicator light.
2. In the MODULATION FX section, press the [ON] button to make the indicator light. The effect will turn on/off each time you press the button.
3. In the MODULATION FX section, turn the [TYPE] knob to select the effect type. For a list of the effects that can be used in modulation FX, refer to "Parameter Guide (English)" (PDF).
4. In the MODULATION FX section, turn the [DEPTH], [RATE] and [FEEDBACK] knobs to adjust the effect.

### MEMO

For details on the effect parameters, refer to "Parameter Guide (English)" (PDF). For details on how to obtain the PDF, refer to "Obtaining PDF Manuals" on the front cover.

- \* You can assign this to a pedal by setting the Program Edit "Pedal" parameter. In this case, if the SYSTEM setting "Control Destination" is set to PROGRAM, you can control the tones whose zone setting (ZONE EDIT) has a check mark for "MOD FX (Modulation FX Control Destination)".

## Applying Tremolo (TREMLO)

In the TREMOLO section, you can adjust the rate and depth of the tremolo effect.

### MEMO

Tremolo is applied only to zones 1–4. It does not apply to zones 5–8.



1. Press the [ZONE EFFECTS] button to make the indicator light.
2. In the TREMOLO section, press the [ON] button to make the indicator light. The tremolo will turn on/off each time you press the button.
3. In the TREMOLO section, turn the [TYPE] to select the tremolo waveform.
4. In the TREMOLO section, turn the [DEPTH] and [RATE] knobs to adjust the tremolo.

## Adjusting the Distortion (AMP SIM)

In the AMP SIM section, you can adjust the amount of distortion.



1. Press the [ZONE EFFECTS] button to make the indicator light.
2. In the AMP SIM section, press the [ON] button to make the indicator light.  
The amp simulator will turn on/off each time you press the button.
3. In the AMP SIM section, turn the [DRIVE] knob to adjust the amount of distortion.

### MEMO

You can assign tremolo and amp simulator to a pedal by editing the Program Edit "Pedal" parameter.

In this case, if the SYSTEM setting "Control Destination" is set to PROGRAM, you can control the tones whose zone setting (ZONE EDIT) has a check mark for "TR/AMP (Tremolo/Amp Control Destination)".

## Switching the Tremolo Type and the AMP SIM Type

1. While holding down the TREMOLO [ON/OFF] button or the AMP SIM [ON/OFF] button, press the [INC] [DEC] buttons or turn the value dial.

### MEMO

For more about tremolo and amp simulator, refer to "Parameter Guide (English)" (PDF). For details on how to obtain the PDF, refer to "Obtaining PDF Manuals" on the front cover.

## Adjusting the Levels of Each Frequency Range (EQUALIZER)

The RD-2000 is equipped with a five-band equalizer.



1. Use the ZONE EFFECTS [SELECT] button to select "EQ".
2. Press the [EQ ON] button to make the indicator light.
3. Turn the knobs to adjust the levels in each range.

### NOTE

Sounds may be distorted with certain knob settings. If this occurs, adjust the Input Gain.

### MEMO

- You can specify that the equalizer settings do not change even when you switch programs. In "system settings", set EQ Mode (p. 26) to "REMAIN".
- For details on the equalizer, refer to the "Parameter Guide (English)" (PDF).  
For details on how to obtain the PDF, refer to "Obtaining PDF Manuals" on the front cover.

## Controlling the Functions Assigned to the Knobs (ASSIGN)

### Assigning functions to the knobs or the buttons

1. Use the ZONE EFFECTS [SELECT] button to select "ASSIGN".
2. Hold down the [SHIFT] button and turn one of the ASSIGN [1]–[8] knobs. Or, hold down the [SHIFT] button and press the ASSIGN [9] button.

The Assign1-9 screen appears. Here you can specify the functions that are assigned to the ASSIGN [1]–[8] knobs and the ASSIGN [9] button.

### Using a function that's assigned to a knob or button

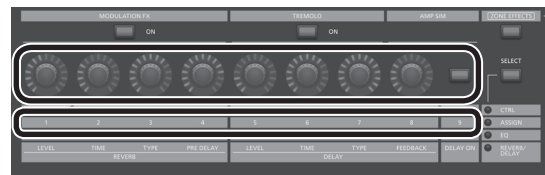

1. Use the ZONE EFFECTS [SELECT] button to select "ASSIGN".
2. Turn the ASSIGN [1]–[8] knobs to adjust the depth of the effect.

By pressing the ASSIGN [9] button, you can switch the effect of the assigned function.

### NOTE

Each effect is applied only to the zone that's selected by SELECT. If the SYSTEM setting "Control Destination" is set to PROGRAM, operating the various ASSIGN knobs or the ASSIGN [9] button does not apply an effect to zones whose zone setting (ZONE EDIT) "A1–A9 (Assign 1–9 Control Switch)" check box is not selected.

### MEMO

Depending on the state of the selected program or tone, the assigned function might not be supported, so that you might not obtain the effect you expect.

The values that are recalled when you switch sounds will be either the default values or the most recently-operated value.

## Performing Live with a Plug-in Synthesizer

Here's how you can use the RD-2000 to play a plug-in synthesizer that's installed on your computer.

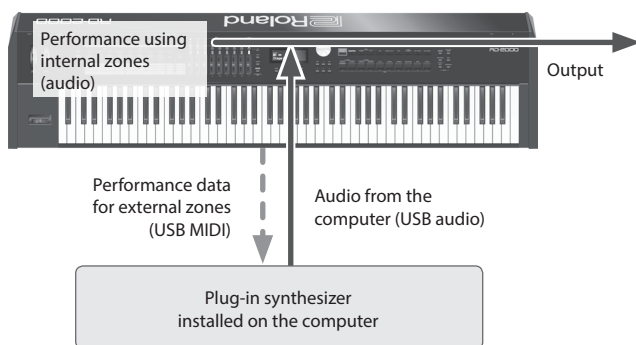

### Connecting to your computer

In order to use the RD-2000, you need to download the driver from the following URL and install it on your computer. For details on installation, refer to the Roland website.

➔ <http://www.roland.com/support/>

### USB driver settings

Here's how to specify the USB driver that's used when connecting the RD-2000 to your computer via the USB COMPUTER port.

1. In the MENU screen, select "SYSTEM" and press the [ENTER] button.
2. Set the "USB Driver" parameter to "VENDER".

Parameter [◀] [▶]	Value [DEC] [INC]	Explanation
USB Driver	VENDER	Choose this if you want to use a USB driver downloaded from the Roland website.
	GENERIC	Choose this if you want to use the standard USB driver that was included with your computer. * Only MIDI is available.

3. Save the setting.  
➔ "Saving the system settings" (p. 26)
4. Turn the power of the RD-2000 off, then on again.

### Using MIDI controller functions

Data produced by operating the RD-2000's knobs and keyboard can be transmitted as MIDI messages from the RD-2000's MIDI OUT connector and from USB MIDI OUT.

1. Press the SELECT button of the zone that you want to transmit MIDI.
2. Hold down the [SHIFT] button, and press the INT/EXT button of the selected zone several times to make it light green.  
MIDI messages are transmitted according to the settings of the zone. MIDI messages are not transmitted if the button is unlit or lit red.
3. Press the ZONE EFFECTS [SELECT] button several times to select "CTRL" or "ASSIGN".  
Knob [1]–[8] information is transmitted if "CTRL" or "ASSIGN" are selected.  
If "EQ" or "REVERB/DELAY" are selected, MIDI messages are not transmitted.
4. Make the slider [LEVEL] button or [ASSIGN] button light.  
Sliders [S1]–[S8] transmit MIDI messages according to the state of the [LEVEL] button or [ASSIGN] button.

### MEMO

You can make detailed settings in the "EXTERNAL" tab of ZONE EDIT (p. 21).

5. Save the specified settings as a scene or program.

- ➔ "Registering a scene" (p. 15)
- ➔ "Saving the Sound Settings in a Program (Program Write)" (p. 23)

### Naming an external zone (Ext Label Edit)

You can assign a label to each external zone.

These labels are shown as the external device name in various screens.

1. Press the [MENU] button.
2. Use the Cursor buttons to select "Ext Label Edit", and then press the [ENTER] button.
3. Select the zone that you want to name, and press the [ENTER] button.

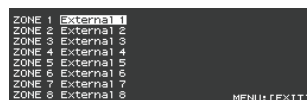

If you decide to cancel, press the [EXIT] button.

4. Assign a name and press the [ENTER] button.

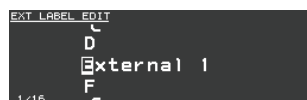

For details on how to enter a name, refer to "Saving the Sound Settings in a Program (Program Write)" (p. 23).

A confirmation message appears.

If you decide to cancel, press the [EXIT] button.

### Optimizing settings for recording on an external sequencer (Rec Mode)

If you're using an external sequencer to record internal parts, it's convenient to use the Rec Mode function.

The Rec Mode function lets you use settings that are optimal for recording to an external sequencer, without having to edit the zone or channel settings.

1. In the MENU screen, select "Local Control" and press the [ENTER] button.
2. Set the Rec Mode parameter.

Parameter [◀] [▶]	Value [DEC] [INC]	Explanation
Rec Mode	OFF, ON	When this is set to ON, settings appropriate for recording are used with respect to the output from MIDI OUT, regardless of the INTERNAL layer settings. Ordinarily, this should be set to OFF. (OFF when the system is started up)

## Using USB Audio

You can connect the RD-2000 via USB to a computer, and use it to handle audio signals.

To use USB audio functionality, install the "VENDER" driver.

➔ For details, refer to "Connecting to your computer" (p. 18).

### Adjusting the USB audio input

Here's how to make settings for audio that's input from a USB-connected computer.

1. In the ZONE area, press the SELECT [USB-AUDIO] button.  
The USB-AUDIO menu appears.
2. Use the cursor buttons to select "USB Audio Input Switch".
3. Use the [DEC] [INC] buttons or the value dial to turn the setting "ON".  
Audio input from the connected device turns on.
4. Use the cursor buttons to select "USB Audio Input Volume", and use the [DEC][INC] buttons or the value dial to adjust the input level.

### MEMO

If "USB Audio In/Out Select" is set to IN, you can also use the slider to adjust the value.

### Adjusting the USB audio output

Here's how to output the RD-2000's audio to a USB-connected computer.

1. In the ZONE area, press the SELECT [USB-AUDIO] button.  
The USB-AUDIO menu appears.
2. Use the cursor buttons to select "USB Audio Output Switch".
3. Use the [DEC] [INC] buttons or the value dial to turn the setting "ON".  
Audio output to the connected device turns on.
4. Use the cursor buttons to select "USB Audio Output Level", and use the [USB-AUDIO] slider to adjust the output level.

You can also use the [DEC] [INC] buttons or the value dial to change the value.

### Using the panel controls to adjust USB audio

Here's how to choose whether the panel button, knob, and slider will control the input or the output.

1. In the ZONE area, press the SELECT [USB-AUDIO] button.  
The USB-AUDIO menu appears.
2. Use the cursor buttons to select "USB Audio In/Out Select".
3. Use the [DEC] [INC] buttons or the value dial to change the setting.  
The color of the INT/EXT button changes depending on the setting.

USB Audio In/Out Select	[INT/EXT] button color
INPUT	Green
OUTPUT	Red

### MEMO

You can also change the setting by holding down the [SHIFT] button and pressing the INT/EXT button in the ZONE area.

## Using SUB OUT

As output destinations for audio signals, the RD-2000 provides SUB OUT jacks in addition to the MAIN OUT jacks.

As appropriate for your situation, you can use these jacks to output audio signals from zones or from USB audio.

### NOTE

- MASTER VOLUME does not affect audio signals that are output to SUB OUT.  
The audio output level is determined by the level setting of each zone.
- Reverb and delay do not apply to audio signals that are output to SUB OUT.

### Settings for each zone

1. Hold down the [SHIFT] button and press a SELECT [1]-[8] button.  
The ZONE EDIT screen appears.
2. Use the cursor buttons to select the "VOL" tab for "INTERNAL".
3. Use the cursor buttons to select the item that you want to edit, and use the [DEC][INC] buttons or the value dial to select the value.

MAIN	The audio signal is output from the MAIN OUT jacks.
SUB	The audio signal is output from the SUB OUT jacks.

4. Use the sliders to adjust the level of the specified zones.

### USB audio settings

1. In the ZONE area, press the SELECT [USB-AUDIO] button.  
The USB-AUDIO menu appears.
2. Use the cursor buttons to select "USB Audio Output Assign", and use the [DEC] [INC] buttons or the value dial to select the value.

MAIN	The USB audio signal is output from the MAIN OUT jacks.
SUB	The USB audio signal is output from the SUB OUT jacks.

3. Use the cursor buttons to select "USB Audio In/Out Select", and use the [DEC][INC] buttons or the value dial to select "IN".
4. Use the slider to adjust the USB audio output LEVEL.

### Temporarily outputting from the MAIN OUT jacks

The audio signals that are output from the SUB OUT jacks can also be output from the MAIN OUT jacks.

### NOTE

- Reverb and delay do not apply to zones that are assigned to the SUB OUT jacks.
- If this is set to "MIX", sound is no longer output from the SUB OUT jacks.
- If this is set to "MIX", the MASTER VOLUME affects the sound.

1. In the MENU screen, select "SYSTEM" and press the [ENTER] button.  
The SYSTEM EDIT screen appears.
2. Use the cursor [◀] [▶] buttons to select "SYSTEM" tab.
3. Use the cursor buttons to select "Output Mix/Parallel", and use the [INC][DEC] buttons or the value dial to select the value.

MIX	Audio signals are output from the MAIN OUT jacks regardless of the setting.
PARALLEL	Audio signals are output from the MAIN OUT jacks or from the SUB OUT jacks depending on the setting.



# Editing the Sound

## Adjusting the Character of the Sound (TONE COLOR)

Turning the [TONE COLOR] knob will modify an aspect of the sound, such as its character or acoustic image.



1. Use the ZONE EFFECTS [SELECT] button to select "CTRL".
2. Use the [TONE COLOR] knob to adjust the amount of effect.

### MEMO

- The popup indication will differ depending on the effect.
- When you select a tone or program, the settings will return to the Tone Color default values of each tone.

### NOTE

The effect that changes when you turn a knob can be specified for each program. To specify this, change the System setting "Control Destination" to "PROGRAM", and then use the zone setting (ZONE EDIT) "TON CLR (Tone Color Control Destination)" to select the zone whose effect you want to change.

### MEMO

The adjusted sound can be saved in the program by pressing the [WRITE] button (p. 23).

### Main Effects for Tone Color

- Stereo Width & Pan Key Follow
- Morphing
- Boost
- Harmonic Bar

## Using the Knobs to Adjust the Sound

The RD-2000 lets you easily adjust the sound to your taste. Here's an actual example that shows the steps of adjusting the sound of the RD-2000 and the features that are available.

### Selecting a sound

1. In the TONE screen (p. 7), use the [DEC] [INC] buttons or value dial to select the tone 0069 "Tine E.Piano".



A pleasant-sounding electric piano tone with a mellow feel often used in pop or jazz is selected.

### Adjusting the tonal color of the sound

2. Press the ZONE EFFECTS [SELECT] button several times to make the CTRL LED light. Turn the [TONE COLOR] knob all the way to the left, and then gradually turn it toward the right.



The character of the sound changes; the attack will initially be soft, but this will gradually become harder, finally transforming into a very brilliant sound.

Adjust the character to your taste.

### Adjusting the tremolo

3. Press the [ZONE EFFECT] button to make it light.
4. Press the TREMOLO [ON] button to make it light, turning it on. Then adjust the tremolo effect, which makes the sound sway between left and right.

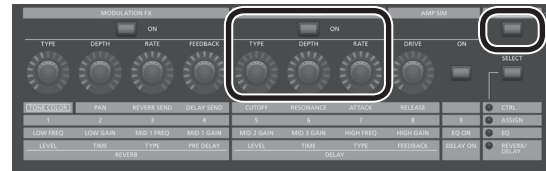

Turning the TREMOLO [RATE] knob changes the speed at which the sound moves between left and right.

Turning the TREMOLO [DEPTH] knob changes the amount by which the sound moves between left and right. Adjust the tremolo as appropriate for the song you're playing.

If you don't want tremolo, turn the TREMOLO [ON/OFF] button off to make it go dark.

### Adjusting the amp simulator

5. Press the AMP SIM [ON/OFF] button to turn it on and make it light; then turn the AMP SIM [DRIVE] knob.



Turning the knob toward the right adds distortion to the sound. Although you're free to make the sound distort intensely, you might want to add just a bit of distortion as a subtle edge.

### Adjusting the modulation FX

6. Press the MODULATION FX [ON/OFF] button to turn it on and make it light.



This lets you apply an effect.

Use the MODULATION FX [RATE] knob and MODULATION FX [DEPTH] knob to adjust the settings to your taste.

You can also switch the MODULATION FX type by holding down the MODULATION FX [ON/OFF] button and using the [DEC] [INC] buttons or the VALUE dial.

### Saving the sound you created

7. When you've adjusted the sound to your liking, save it as a program.
    - ➔ "Saving the Sound Settings in a Program (Program Write)" (p. 23)
- Next time, you can simply select the saved program and immediately start playing the sound that you adjusted to your taste.



## Editing a Program (Program Edit)

1. In the PROGRAM screen, press the [EDIT] button.

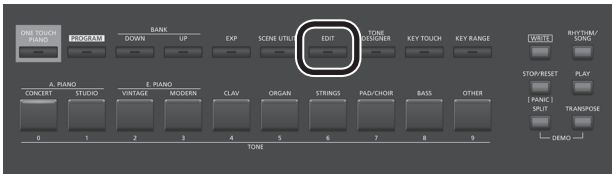

The PROGRAM EDIT MENU screen appears.

2. Use the cursor buttons to select the item that you want to edit, and press the [ENTER] button.

The corresponding edit screen appears.

### Program Edit Menu

Zone Edit	Makes settings for each zone (1–8).
Key Touch	Edits the keyboard touch sensitivity.
Pedal	Edits the pedal settings.
Assign	Specifies the function of the modulation wheels, sliders, ASSIGN [1]–[8] knobs, and ASSIGN [9] button.
Reverb	Edits the reverb settings.
Delay	Edits the delay settings.
EQ	Edits the equalizer settings.

➔ For details on the program edit, refer to “Parameter Guide (English)” (PDF). For details on how to obtain the PDF, refer to “Obtaining PDF Manuals” on the front cover.

3. Select the parameter that you want to edit, and use the [DEC] [INC] buttons or the value dial to edit the value.  
Press the [EXIT] button to return to the PROGRAM EDIT Menu screen.
4. Repeat steps 2–3 to continue editing.
5. When you’ve finished making settings, press the [EXIT] button several times to return to the Tone screen or the Program screen.

### NOTE

If you’ve edited the settings, an “EDITED” indication is shown in the Program screen or the Tone screen.



If you turn off the power, select another Program, or select another tone in the Tone screen while the “EDITED” indication is shown, the edits you made are discarded. If you want to keep your edits, press the [WRITE] button to save the Program (p. 23).

## Editing a Tone (Designer)

By using the Designer function, you can make more detailed settings for a tone.

1. Use the SELECT [S1]–[S8] buttons to select a zone, and press the [TONE DESIGNER] button.

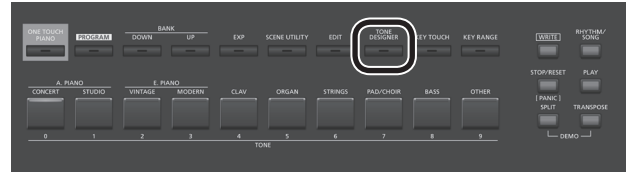

The TONE DESIGNER MENU screen (in the case of TW-Organ sounds, the Tone Wheel & Designer Menu screen) of the selected ZONE appears.

In the Designer menu you’ll choose the broad category of tone settings that you want to edit.

2. Use the cursor buttons to select the item that you want to edit, and press the [ENTER] button.

The corresponding edit screen appears.

### Designer Menu

Piano Designer (only for certain piano sounds)	Lets you create your own personalized piano sound by adjusting various aspects of a piano's tonality.
Tone Designer (other than certain piano sounds)	Edits detailed settings of the piano sound. The editable parameters will depend on the piano sound that is selected.
Indiv. Voicing (only for certain piano sounds)	Edits the pitch, volume, and character of each key.
Sym. Resonance (only for certain piano sounds)	Edits the sympathetic resonances that are heard when you hold down the damper pedal.
Modulation FX	Edits parameters that are related to Modulation FX.
Tremolo /AMP Sim	Edits parameters that are related to tremolo and amp simulator.
TONE WHEEL&Designer Menu (TW-Organ sounds only)	Edits TW-Organ sounds.

➔ For details on the designer, refer to “Parameter Guide (English)” (PDF). For details on how to obtain the PDF, refer to “Obtaining PDF Manuals” on the front cover.

### MEMO

The items that you can set will differ depending on the type of sound.

### NOTE

If you’ve edited the settings, an “EDITED” indication is shown in the Program screen or the Tone screen.



If you turn off the power, select another Program, or select another tone in the Tone screen while the “EDITED” indication is shown, the edits you made are discarded. If you want to keep your edits, press the [WRITE] button to save the Program (p. 23).

## Creating the Organ Tones

### NOTE

These settings are available only when a TW-Organ sound is selected.

Some organ feature nine “harmonic bars” that can be drawn in and out, and by using the bars in different combinations of positions, a variety of different tones can be created. Different “Feet” are assigned to each bar, with the pitches of the sounds being determined by these “Feet”. You can create of tones using the Layer LEVEL sliders just as you operate the harmonic bars.

### What are “feet?”

Feet basically refers to the lengths of pipe used in pipe organs.

The length of pipe used to produce the reference pitch (the fundamental) for the keyboard is eight feet. Reducing the pipe to half its length produces a pitch one octave higher; conversely, doubling the pipe length creates a pitch one octave lower.

Therefore, a pipe producing a pitch one octave below that of the reference of 8’ (eight feet) would be 16’; for one octave above the reference, the pipe would be 4’; and to take the pitch up yet another octave it would be shortened to 2’.

1. Use the SELECT [S1]–[S8] buttons to select the zone to which a TW Organ sound (a sound for which the  icon is shown) is assigned; then hold down the [SHIFT] button and press the “SCENE” button.



The Tone Wheel & Designer Menu screen of the selected layer appears.

2. Move the LAYER LEVEL sliders.

The sound changes in tandem with the indication in the screen. You can use the cursor [K] [J] buttons to switch between harmonic bar and percussion switch groups.

### MEMO

Percussion adds a sound with a sense of attack at the beginning of the note, giving the sound a crisper feel. The attack sound will change depending on this value.

Parameter [◀] [▶]	Value [DEC] [INC]	Explanation
Percussion Switch	OFF	No percussion is added.
	2nd	Percussion sounds at a pitch one octave above that of the key pressed.
	3rd	Percussion sounds at a pitch an octave and a fifth above that of the key pressed.
Percussion Volume	Soft	The percussion sound is diminished, and the harmonic bars produce their normal volume.
	Normal	The percussion sound will be at its normal volume, and the sound of the harmonic bars is diminished.
Percussion Decay	Slow	The percussion’s attenuation time is lengthened. This softens the sense of attack.
	Fast	The percussion sound decays more quickly. This gives more of a sense of attack for a sharp sound.

### NOTE

When percussion is on, the 1’ pitch will not be produced.

### MEMO

- You can also use the cursor [◀] [▶] buttons to move the cursor to the Modulation FX or Tremolo/Amp Simulator menu items.
- When the cursor is located at Modulation FX or Tremolo/Amp Simulator, you can go to the corresponding item by pressing the [ENTER] button. For details on the effect parameters, refer to “Parameter Guide (English)” (PDF). For details on how to obtain the PDF, refer to “Obtaining PDF Manuals” on the front cover.
- When a TW-Organ sound is selected, turning the [TONE COLOR] knob will move all of the harmonic bars simultaneously.

### Changing the undulation of the organ tone (Rotary Effect)

While the Tone Wheel & Designer Menu screen is displayed, you can change the undulation rate of the Rotary effect with the Pitch Bend lever. The Rotary effect is an effect that recreates the sound of the rotating speakers used to augment the sound of an organ. Moving the pitch bend lever to left or right will toggle the Rotary effect between fast and slow regardless of the direction in which you move the lever.

### MEMO

This Pitch Bend Lever setting is effective only in the Tone Wheel & Designer Menu screen.

## Viewing the State of Each Zone (Zone Info Screen)

The zone info screen shows a list of each zone’s settings.

1. While in the tone screen, program screen, or scene screen, press the [ENTER] button.

The settings of zones 1–8 appear.



Bright text: the zone is on.

Dim text: the zone is off.

2. Press the [EXIT] button to return to the previous screen.

### MEMO

You can’t edit the settings in the zone info screen.

If you edit a sound or switch modes while this screen is displayed, this screen closes and the necessary screen appears.

## Saving the Sound Settings in a Program (Program Write)

1. Press the [WRITE] button to make it light.

The PROGRAM NAME screen appears.

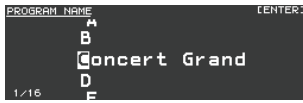

2. Use the cursor [◀] [▶] buttons to move the cursor to the position at which you want to enter a character.
3. Use the [DEC] [INC] buttons or the value dial to enter the characters.

Operation	Explanation
[SHIFT] + [◀] button	Delete one character (DELETE)
[SHIFT] + [▶] button	Insert one space (INSERT)
[▲] [▼] buttons	Switch uppercase/lowercase

4. Repeat steps 2–3 to input the name.
5. When you have finished entering the name, press the [ENTER] button.
6. Select the save-destination Program number, either by using the [DEC] [INC] buttons or the value dial.

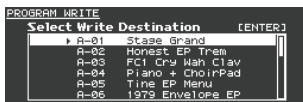

7. When you have specified the save-destination, press the [ENTER] button.

A confirmation message appears.

8. Move the cursor to "OK" and press the [ENTER] button.

The program is saved.

### NOTE

Never switch off the power while "Executing..." appears in the display.

### Specifying the sound selected at startup (STARTUP)

The RD-2000 lets you specify the state (sound) in which it will power-on.

1. Select the desired sound.

Selecting a TONE → "Selecting a tone" (p. 14)

Selecting a PROGRAM → "Selecting a program" (p. 15)

### MEMO

When you register to STARTUP, it will also be called when you press the [ONE TOUCH PIANO] button.

Even if you register the program, it's called as the TONE.

When you register the program, the PROGRAM NAME is discarded.

2. Hold down the [WRITE] button and press the [ONE TOUCH PIANO] button.

3. Move the cursor to "OK" and press the [ENTER] button.

The current setting will be saved to STARTUP.

The next time you start the RD-2000, it will start up with the STARTUP condition (sound) that you saved.

## Changing the Order of Programs (Program Swap)

You can arrange the Programs into the order you like.

It is convenient to arrange Programs in the order in which you'll be using them for your live performance.

1. From the MENU screen, choose "Program Utility" → "Swap".

The Program Swap screen appears.



### NOTE

You can't use the Program Swap function in the following situations.

- In the Menu screen, Write screen, or Demo screen.
- When RHYTHM, AUDIO PLAY, or AUDIO REC are operating.

2. You can use the [INC] [DEC] buttons and value dial to change the swap-destination Program.

3. Press the [ENTER] button.

A confirmation message appears.

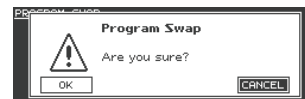

4. Move the cursor to "OK" and press [ENTER] button to execute the swap.

Repeat steps 2–4 as necessary.

If you decide to cancel Program Swap, press the [EXIT] button.

### MEMO

When the Program Swap operation is completed, the swap-source program number is selected.

### NOTE

Never switch off the power while "Executing..." appears in the display.

# Using the Convenient Functions in Performances

## Playing Rhythm

1. Press the [RHYTHM/SONG] button to make it light.

The Song or Rhythm screen appears.

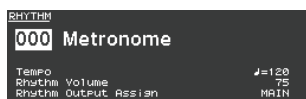

Each time you press the [RHYTHM/SONG] button, you'll alternate between the Song screen and the Rhythm screen.

2. Press the [RHYTHM/SONG] button several times to access the Rhythm screen.

3. Press the [PLAY] button to make it light.

The rhythm will begin playing.

To stop the rhythm, press the [STOP/RESET] button.

### NOTE

While the rhythm is playing, pressing the [SONG/RHYTHM] button will not switch to the SONG screen.

### Changing the rhythm pattern

1. In the Rhythm screen, move the cursor to the rhythm number in the screen.
2. Use the [DEC] [INC] buttons or value dial to change the patterns, and press the [ENTER] button.

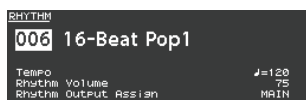

For more about the rhythm patterns, refer to "Sound List" (PDF). For details on how to obtain the PDF, refer to "Obtaining PDF Manuals" on the front cover.

### MEMO

A recommended drum kit will be selected for each rhythm pattern.

### Changing the rhythm tempo or volume

1. In the Rhythm screen, move the cursor to Tempo or Rhythm Volume.
2. Use the [DEC] [INC] buttons or the value dial to adjust the tempo or rhythm volume.



### Outputting to SUB OUT

1. In the Rhythm screen, move the cursor to Rhythm Output Assign.
2. Use the [DEC][INC] buttons or the value dial to change the output destination.

## Recording Audio

### Connecting the USB flash drive

1. Connect your USB flash drive (sold separately) to the USB MEMORY port located on the back of the RD-2000.

### Preparing to record

#### NOTE

Do not disconnect the USB flash drive during audio recording. Doing so may cause all the data in the USB flash drive to be lost.

1. Select the tone or Program that you want to play (p. 14, p. 15).
2. Press the [RHYTHM/SONG] button several times to access the SONG screen.
3. Hold down the [SHIFT] button and press the [RHYTHM/SONG] button to initiate record-standby.

If the rhythm was sounding, it will stop. The [RHYTHM/SONG] button will light, and the [PLAY] button will blink.

If you want to cancel recording, press the [STOP/RESET] button.

### Start recording

1. Press the [PLAY] button.

The [PLAY] button will light, and recording will start.

### Stop recording

1. Press the [STOP/RESET] button.

Recording will stop, and the recorded data will be saved on the USB flash drive.

### Recorded audio file format

File Extension	WAV
Sampling Frequency	44.1 kHz
Bit Depth	16-bit

### Deleting the recorded data

1. Press the [PLAY] button to audition the song you recorded. Press the [STOP/RESET] button once again to stop playback.
2. In the Song screen, move the cursor to Song Delete and press the [ENTER] button.
3. Move the cursor to "OK" and press the [ENTER] button.

### About USB flash drives

If you're using a new USB flash drive, you must first initialize (format) it on the RD-2000. For details, refer to "Formatting Memory (Format)" (p. 26).

#### NOTE

- Never insert or remove the USB flash drives while this unit is turned on. Doing so may corrupt the unit's data or the data on the flash drives.
- Use a commercially available USB flash drive or a USB flash drive sold by Roland. However, we cannot guarantee that all commercially available USB flash drives will work with this unit.

## Playing Audio Files from USB Flash Drive

### MEMO

- If the USB flash drive contains numerous song files, it may take some time for the data to be loaded.
- Use single-byte alphanumeric characters for the file name.
- A maximum of 200 files can be recognized within each folder.

### WAV format files that can be played

Sampling Frequency	44.1 kHz
Bit Depth	16-bit

- \* Changing the Play Speed or Playback Transpose of an audio file places a significant processing load on the RD-2000; in some cases this could make the RD-2000 unable to completely process the performance data from the keyboard.

### Playing back

1. Press the [RHYTHM/SONG] button to make it light.  
The Rhythm or Song screen appears.  
Each time you press the [RHYTHM/SONG] button, you'll alternate between the RHYTHM screen and the SONG screen.
2. Press the [RHYTHM/SONG] button several times to access the Song screen.
3. Press the [PLAY] button to make it light; the audio file will play.  
To stop the audio file playback, press the [STOP/RESET] button.

### NOTE

If an audio file is playing, pressing the [RHYTHM/SONG] button will not switch to the Rhythm screen.

### Selecting an audio file

1. In the Song screen, move the cursor to the song number in the screen.
2. Use the [DEC] [INC] buttons or the value dial to select a song number.  
If there is no playable song, the song number will be shown as "----" and the [INC] [DEC] buttons will not work.

### Selecting an audio file in a folder

1. Use the [DEC] [INC] buttons or the value dial to select a folder.  
The folder icon will be displayed.
2. Press the [ENTER] button.  
The audio files inside the folder will be displayed.
3. Use the [DEC] [INC] buttons or the value dial to select an audio file.  
To exit the folder, choose "up" and press the [ENTER] button.

### MEMO

- Use single-byte alphanumeric characters for the file name.
- A maximum of 200 files can be recognized within each folder.

### Fast-forwarding or rewinding an audio file

1. In the Song screen, move the cursor to the Time Position.
2. Use the [DEC] [INC] buttons or the value dial to change the value.  
The playback position will change according to the indication.

### Changing how audio files play

1. In the Song screen, move the cursor to the various items.
2. Use the [DEC] [INC] buttons or the value dial to change the value.

Parameter [◀] [▶]	Value [DEC] [INC]	Explanation
Speed	75%–125%	Lets you change the playback speed of the song.
Playback Transpose	-6–0–5	Lets you shift the playback key of a song in semitone steps.
Time Position	00'00"–	Specifies the time location at which playback starts (when stopped). Indicates the elapsed playback time (while playing).
Audio Volume	0–127	Sets the volume for audio file playback.
Audio Output Assign	MAIN, SUB	Specifies the audio output destination.
Center Cancel	OFF, ON	Causes sounds located in the center (e.g., vocals or melodic instruments) to be reduced in volume.
Play Mode	ONE SONG	When you play back a song, only one song will play; playback will stop at the end of that song.
	ALL SONG	The songs in USB flash drive will play consecutively.

### Renaming an audio file

1. In the Song screen, choose "Song Rename" and press the [ENTER] button.
2. Use the cursor [◀] [▶] buttons to move the cursor to the position at which you want to enter a character.
3. As necessary, use the [DEC] [INC] buttons or the value dial to enter a name.

Operation	Explanation
[SHIFT] + [◀] button	Delete one character (DELETE)
[SHIFT] + [▶] button	Insert one space (INSERT)
[▲] [▼] buttons	Switch uppercase/lowercase

### NOTE

You can't save an audio file with a name that starts with a "." (period).  
Do not use a "." (period)" at the beginning of the name.

4. Repeat steps 2–3 to enter the name.  
If you press the [EXIT] button, the rename operation will be cancelled and you'll return to the previous screen.
5. Press the [ENTER] button.  
A confirmation message appears.
6. Move the cursor to "OK" and press the [ENTER] button.  
The song name is confirmed.

### Deleting an audio file

1. In the Song screen, choose "Song Delete" and press the [ENTER] button.  
A confirmation message appears.
2. Move the cursor to "OK" and press the [ENTER] button.  
The song will be deleted.

### NOTE

- Never turn off the power while deletion is in progress.
- Do not disconnect the USB flash drive while deletion is in progress.



# Various Settings

## Accessing the Menu Screens

### Setting parameters

1. Press the [MENU] button.



2. Use the cursor buttons to select the item that you want to edit, and press the [ENTER] button.  
The corresponding edit screen appears.
3. Select the parameter that you want to edit, and use the [DEC] [INC] buttons or the value dial to edit the value.
4. When you've finished making settings, press the [EXIT] button several times to return to the Tone screen or the Program screen.

### MEMO

The following settings will be stored as common settings for the entire RD-2000 when you press the [WRITE] button in an edit screen.

- System

### Editable items

Program Edit	Edit a program.
Program Utility	Manage program files and songs.
Scene Utility	Initialize a scene or enter a memo.
Ext Label Edit	Assign labels to external zones. The label is shown as the external device name in various screens.
Local Control	Specify the connection between the controller section and the sound engine.
System	Make settings that affect the operating environment of the entire RD-2000.
Utility	Make settings that specify how your RD-2000 performance will be recorded on an external sequencer, or initialize the RD-2000 itself or a USB flash drive.
Demo Play	Play demo songs.

## Setting Parameters (System)

Functions that affect the overall operating environment of the RD-2000 are called "system functions".

1. In the MENU screen, select "SYSTEM" and press the [ENTER] button.

The SYSTEM EDIT screen appears.

2. Use the cursor [◀] [▶] buttons to switch tabs.

Parameter [▲] [▼]	Value [DEC] [INC]	Explanation
<b>SYSTEM tab</b>		
Master Tune	415.3–440.0–466.2 [Hz]	Tuning to other instruments' pitches
Control Destination	SELECT, PROGRAM	Specifying the target of knobs and other controllers SELECT: Only the selected zone PROGRAM: Program settings
EQ Mode	PROGRAM, REMAIN	
Select Button Mode	PROGRAM, REMAIN	Specifying whether, when you switch programs, the settings of the newly selected program are applied (PROGRAM) or the settings prior to the change are retained (REMAIN)
Pedal Mode	PROGRAM, REMAIN	
Wheel Mode	PROGRAM, REMAIN	

Parameter [▲] [▼]	Value [DEC] [INC]	Explanation
Assign 1-9 Mode	PROGRAM, REMAIN	
Delay Mode	PROGRAM, REMAIN	Specifying whether, when you switch programs, the settings of the newly selected program are applied (PROGRAM) or the settings prior to the change are retained (REMAIN)
Reverb Mode	PROGRAM, REMAIN	
Rhythm Mode	PROGRAM, REMAIN	
Key Touch Mode	TONE/PROGRAM, REMAIN	Specifying whether, when you switch tones or programs, the settings of the newly selected program or tone are applied (TONE/PROGRAM) or the settings prior to the change are retained (REMAIN)
Tone/Program Remain	OFF, ON	Retaining the current tone even when tones are switched
Tone Ext Zone Remain	OFF, ON	Retaining the external zone settings even when zones are switched
Program Control Channel	OFF, 1–16	Using program change messages to switch program
USB Driver	VENDER, GENERIC	Selecting the USB driver
USB MIDI Thru Switch	OFF, ON	Selecting the USB MIDI thru switch
MIDI OUT2 Port Mode	OUT, THRU	Selecting the function of the MIDI THRU/OUT 2 connector
Damper Polarity	STANDARD, REVERSE	Switching the pedal's polarity
FC1 Polarity	STANDARD, REVERSE	
FC2 Polarity	STANDARD, REVERSE	
EXT Pedal Polarity	STANDARD, REVERSE	
Temperament	EQUAL, JUST MAJ, JUST MIN, PYTHAGOREAN, KIRNBERGER, MEANTONE, WERCKMEISTER, ARABIC	Setting the Tuning Method
Temperament Key	C–B	Sets the keynote.
Clock Out	OFF, ON	Transmitting synchronization messages
Hi-Res Velocity Out	OFF, ON	Transmitting high-resolution velocity data
Rhythm MIDI Output Port	ALL, OUT1, OUT2, USB	Selecting the MIDI output port for rhythm
Rhythm MIDI Out Channel	OFF, 1–16	Selecting the MIDI output channel for rhythm
Audio Volume	0–127	Adjusting the playback volume of audio files
Output Mix/Parallel	MIX, PARALLEL	➔ "Temporarily outputting from the MAIN OUT jacks" (p. 19)
LCD Brightness	1–10	Adjusting the brightness of the display
Auto Off	OFF, 30 [min], 240 [min]	Making the power automatically turn off after a time

### Saving the system settings

1. In the SYSTEM EDIT screen, press the [WRITE] button.  
A confirmation message appears.
2. Move the cursor to "OK" and press the [ENTER] button.  
If you decide to cancel, press the [EXIT] button.

## Formatting Memory (Format)

"Formatting" is the operation of deleting all Program files from user memory or initializing a USB flash drive so that it can be used with the RD-2000.

USB flash drive cannot be used with the RD-2000 unless it is formatted suitably for the RD-2000.

Before using a new USB flash drive, you'll need to format it.

### NOTE

When you format the USB flash drive, all data previously saved on that memory will be erased. Before you carry out a format, make sure



that the USB flash drive does not contain important data you need to keep.

1. In the MENU screen, select "Utility" and press the [ENTER] button.
2. Select "Format USB Memory" and then press the [ENTER] button. A confirmation message appears.



If you decide to cancel the Format operation, press the [EXIT] button.

3. To execute the Format operation, press the [ENTER] button.
4. Move the cursor to "OK" and press the [ENTER] button once again to execute the Format operation.

**NOTE**

- Never turn off the unit while the screen indicates "Executing..."
- Never turn off the power or disconnect the USB flash drive while reading or writing is in progress.

### Returning to the Factory Settings (Factory Reset)

The settings stored in the RD-2000 can be returned to their factory settings.

1. In the MENU screen, select "Utility" and press the [ENTER] button.
2. Select "Factory Reset".
3. Press the [ENTER] button. A confirmation message appears.
4. Move the cursor to "OK" and press the [ENTER] button.

Factory reset is executed.

If you chose "Factory Reset All", turn the power of the RD-2000 off, and then on again.

**NOTE**

Never turn off the power during Factory Reset (while "Executing... Don't Power OFF" appears in the display).

### Making the Power Automatically Turn Off After a Time (Auto Off)

- ➔ Refer to "If you don't want the power to turn off automatically, change the "Auto Off" setting to "Off" (p. 11).

### Listening to the Demo Songs

The RD-2000 features internal demo songs that exhibit the special capabilities of the instrument.

**NOTE**

- All rights reserved. Unauthorized use of this material for purposes other than private, personal enjoyment is a violation of applicable laws.
- No data for the music that is played will be output from MIDI OUT jack.
- When you enter demo mode, various settings are set to their power-on state. If there are settings that you want to keep, save them as a program (p. 23).
- The RD-2000's keyboard will not produce sound while the demo songs are playing.

1. Hold down the [SPLIT] button and press the [TRANPOSE] button.

The Demo screen appears.

2. Use cursor buttons to select a demo song.
3. Press the [ENTER] button to start demo song playback.
4. To stop the demo song mid-way, press the [ENTER] button. While the song is stopped, press the [EXIT] button to return to the TONE screen.

### Backing Up RD-2000 Data to a USB Flash Drive (Backup Save)

1. In the UTILITY screen, select "Backup Save" and press the [ENTER] button.

The BACKUP SAVE screen appears.

2. Enter a file name.

**MEMO**

For details on how to enter a name, refer to "Saving the Sound Settings in a Program (Program Write)" (p. 23).

3. When you have entered the file name, press the [ENTER] button. A confirmation message appears. If you decide to cancel, press the [EXIT] button.
4. Move the cursor to "OK" and press the [ENTER] button. When the backup is completed, a message appears.

### Restoring Backup Data from a USB Flash Drive to the RD-2000 (Backup Load)

Here's how backup data can be written back into the RD-2000.

The RD-2000 can also read Live Set Files that were created on the RD-800.

**NOTE**

- All user data is rewritten when you execute the Load operation. If the RD-2000 contains important data that you want to keep, back it up using a different name on a USB flash drive before you execute the Load operation.
- Never turn off the power or disconnect the USB flash drive while the screen indicates "Processing..."

1. In the UTILITY screen, move the cursor to "Backup Load" and press the [ENTER] button. The BACKUP LOAD screen appears.
2. Use the [DEC] [INC] buttons or the value dial to move the cursor to the file that you want to load.
3. Use the [DEC] [INC] buttons or the value dial to set the Load System Parameters setting.

If NO: Programs and scenes are loaded, but system settings are not loaded.

If YES: In addition to programs and scenes, system settings are also loaded.

**NOTE**

Regardless of this setting, system settings are not read if you selected an RD-800 Live Set File.

4. Press the [ENTER] button. A confirmation message appears. If you decide to cancel, press the [EXIT] button.
5. Move the cursor to "OK" and press the [ENTER] button. When the load is completed, a message appears.

# List of Shortcut Keys

\* “[A]+[B]” indicates the operation of “holding down the [A] button and pressing the [B] button”.

Shortcut	Explanation	Page
<b>Basic operation</b>		
[SHIFT] + [DEC] [INC], Value dial	Makes the value change more greatly. When switching tones, the first sound in the category is selected. When switching Programs, the first sound in the bank is selected.	p. 14
[SHIFT] + [◀] [▶]	If the ZONE EDIT screen is shown, move between tabs.	p. 21
<b>Editing a tone or program</b>		
[TRANSCOPE] + keyboard, [DEC] [INC], Value dial	Specifies the transposition setting of the entire keyboard.	p. 14
[SPLIT] + keyboard	Specifies the split point.	p. 15
[RHYTHM/SONG] + [DEC] [INC]	When rhythm is selected, specifies the rhythm volume. When an audio song is selected, specifies the audio volume.	p. 25
[SHIFT] + ZONE LEVEL slider	Jumps to the VOL (Volume) item of the ZONE EDIT screen.	
[SHIFT] + [TRANSCOPE]	Jumps to the C.Tune (Coarse Tune) item of the ZONE EDIT screen.	
[SHIFT] + [SPLIT]	Jumps to the KR.LWR (Keyboard Range Lo) item of the ZONE EDIT screen.	
[SHIFT] + SELECT [1]–[8]	Jumps to the ZONE EDIT screen.	
[SHIFT] + INT [1]–[8]	Exchanges the INTERNAL/EXTERNAL assignment of the selected zone.	
[SHIFT] + [USB AUDIO]	Jumps to the USB AUDIO tab of the SYSTEM EDIT screen.	
[SHIFT] + [SCENE]	For Tone Wheel Organ sounds, turns HARMONIC BAR mode ON.	
[EXIT] + ZONE LEVEL slider [1]–[8], USB-AUDIO slider, knob	Shows the current value of each slider or knob, allowing you to match the setting (Status & Catch).	
[SHIFT] + [STOP/RESET]	Transmits an All Note Off message to all parts (Panic function).	
<b>Reverb</b>		
[SHIFT] + REVERB knob	Jumps to the Reverb screen.	p. 16
<b>Tone color</b>		
[SHIFT] + TONE COLOR knob	Jumps to the TON CLR (Tone Color Control Destination) item of the ZONE EDIT screen.	p. 20
<b>EQ/delay/assign</b>		
[SHIFT] + each EQ knobs (LOW, MID2, MID3, HIGH)	Jumps to the EQ screen.	p. 17
[SHIFT] + each DELAY knobs (TYPE, LEVEL, FEEDBACK, TIME)	Jumps to the Delay screen.	p. 16
[SHIFT] + each ASSIGN knobs (1–8)	Jumps to the KNOB 1–8 item of the ASSIGN screen in PROGRAM EDIT.	p. 17
[SHIFT] + ASSIGN [9]	Jumps to the SWITCH 9 item of the ASSIGN screen in PROGRAM EDIT.	
<b>Modulation FX</b>		
[SHIFT] + MOD FX [TYPE], [DEPTH], [RATE] knob	Jumps to the Modulation FX screen of the ZONE that's selected in Modulation FX Control Destination.	
[SHIFT] + MOD FX [ON/OFF]	Jumps to the MOD FX (Modulation FX Control Destination) item of the ZONE EDIT screen.	
<b>Tremolo/amp simulator</b>		
TREMOLO [ON/OFF] + [DEC] [INC], Value dial	Changes the tremolo/amp simulator type of the zone that's selected by the SELECT button (or Tremolo/Amp Control Destination).	p. 17
AMP SIM [ON/OFF] + [DEC] [INC], Value dial		
[SHIFT] + TREMOLO [TYPE], [DEPTH], [RATE] knob	Jumps to the Tremolo/Amp Simulator screen of the ZONE EDIT screen.	
[SHIFT] + AMP SIM [DRIVE] knob	Jumps to the TR/AMP (Tremolo/Amp Control Destination) item of the ZONE EDIT screen.	
[SHIFT] + TREMOLO [ON/OFF]		
[SHIFT] + AMP SIM [ON/OFF]		
<b>Pitch bend lever/modulation lever</b>		
[SHIFT] + pitch bend lever	Jumps to the PCH BND (Pitch Bend Control Switch) item of the ZONE EDIT screen.	
[SHIFT] + modulation lever	Jumps to the MOD CTL (Modulation Control Switch) item of the ZONE EDIT screen.	
<b>Mod wheel 1/2</b>		
[SHIFT] + [MOD WHEEL 1/2]	Jumps to the ASSIGN screen MOD WHEEL item of PROGRAM EDIT.	
<b>Pedal</b>		
[SHIFT] + pedal (DAMPER)	Jumps to the Damper (Damper Control Switch) item of the ZONE EDIT screen.	
[SHIFT] + pedal (FC1, FC2, EXT)	Jumps to the Pedal screen.	
<b>Panel lock</b>		
[MENU] + [ENTER]	Enables panel lock.	p. 14
<b>When entering a name</b>		
[▲] [▼]	Switch uppercase/lowercase.	p. 23, p. 25
[SHIFT] + [◀]	Delete one character (DELETE).	
[SHIFT] + [▶]	Insert one space (INSERT).	