

EDIROL

STUDIO Canvas **SD-20** *24bit Digital*

Owner's Manual Bedienungsanleitung Mode d'emploi Manuale d'uso Manual del usuario

Thank you, and congratulations on your choice of the SD-20.

Before using this unit, carefully read the sections entitled: "USING THE UNIT SAFELY" and "IMPORTANT NOTES" (Owner's manual pp. 3--5). These sections provide important information concerning the proper operation of the unit. Additionally, in order to feel assured that you have gained a good grasp of every feature provided by your new unit, Owner's manual should be read in its entirety. The manual should be saved and kept on hand as a convenient reference.

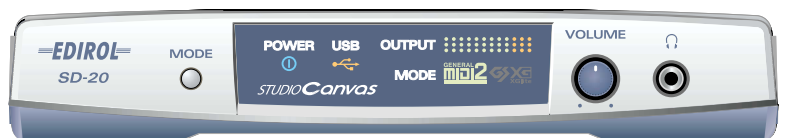

Copyright © 2002 ROLAND CORPORATION

All rights reserved. No part of this publication may be reproduced in any form without the written permission of ROLAND CORPORATION.

For the U.K.

IMPORTANT: THE WIRES IN THIS MAINS LEAD ARE COLOURED IN ACCORDANCE WITH THE FOLLOWING CODE.

BLUE: NEUTRAL
BROWN: LIVE

As the colours of the wires in the mains lead of this apparatus may not correspond with the coloured markings identifying the terminals in your plug, proceed as follows:

The wire which is coloured BLUE must be connected to the terminal which is marked with the letter N or coloured BLACK.
The wire which is coloured BROWN must be connected to the terminal which is marked with the letter L or coloured RED.
Under no circumstances must either of the above wires be connected to the earth terminal of a three pin plug.



For EU Countries

This product complies with the requirements of European Directive 89/336/EEC.

For the USA

FEDERAL COMMUNICATIONS COMMISSION RADIO FREQUENCY INTERFERENCE STATEMENT

This equipment has been tested and found to comply with the limits for a Class B digital device, pursuant to Part 15 of the FCC Rules. These limits are designed to provide reasonable protection against harmful interference in a residential installation. This equipment generates, uses, and can radiate radio frequency energy and, if not installed and used in accordance with the instructions, may cause harmful interference to radio communications. However, there is no guarantee that interference will not occur in a particular installation. If this equipment does cause harmful interference to radio or television reception, which can be determined by turning the equipment off and on, the user is encouraged to try to correct the interference by one or more of the following measures:

- Reorient or relocate the receiving antenna.
- Increase the separation between the equipment and receiver.
- Connect the equipment into an outlet on a circuit different from that to which the receiver is connected.
- Consult the dealer or an experienced radio/TV technician for help.

This device complies with Part 15 of the FCC Rules. Operation is subject to the following two conditions:

- (1) This device may not cause harmful interference, and
- (2) This device must accept any interference received, including interference that may cause undesired operation.

Tested To Comply With FCC Standards

FOR HOME OR OFFICE USE

Unauthorized changes or modification to this system can void the users authority to operate this equipment.
This equipment requires shielded interface cables in order to meet FCC class B Limit.

For Canada

NOTICE

This Class B digital apparatus meets all requirements of the Canadian Interference-Causing Equipment Regulations.

AVIS

Cet appareil numérique de la classe B respecte toutes les exigences du Règlement sur le matériel brouilleur du Canada.

For the USA



DECLARATION OF CONFORMITY Compliance Information Statement

Model Name : SD-20
Type of Equipment : Sound Module
Responsible Party : Edirol Corporation North America
Address : 425 Sequoia Drive, Suite 114, Bellingham, WA 98226
Telephone : (360) 594-4276







USING THE UNIT SAFELY

INSTRUCTIONS FOR THE PREVENTION OF FIRE, ELECTRIC SHOCK, OR INJURY TO PERSONS

About  WARNING and  CAUTION Notices

 WARNING	Used for instructions intended to alert the user to the risk of death or severe injury should the unit be used improperly.
 CAUTION	Used for instructions intended to alert the user to the risk of injury or material damage should the unit be used improperly. * Material damage refers to damage or other adverse effects caused with respect to the home and all its furnishings, as well to domestic animals or pets.

About the Symbols

	The  symbol alerts the user to important instructions or warnings. The specific meaning of the symbol is determined by the design contained within the triangle. In the case of the symbol at left, it is used for general cautions, warnings, or alerts to danger.
	The  symbol alerts the user to items that must never be carried out (are forbidden). The specific thing that must not be done is indicated by the design contained within the circle. In the case of the symbol at left, it means that the unit must never be disassembled.
	The  symbol alerts the user to things that must be carried out. The specific thing that must be done is indicated by the design contained within the circle. In the case of the symbol at left, it means that the power-cord plug must be unplugged from the outlet.



ALWAYS OBSERVE THE FOLLOWING

WARNING

- 001** Before using this unit, make sure to read the instructions below, and the Owner's Manual. 

- 002c** Do not open (or modify in any way) the unit or its AC adaptor. 

- 003** Do not attempt to repair the unit, or replace parts within it (except when this manual provides specific instructions directing you to do so). Refer all servicing to your retailer, the nearest EDIROL/Roland Service Center, or an authorized EDIROL/Roland distributor, as listed on the "Information" page. 



- 004** Never use or store the unit in places that are:
 -  Subject to temperature extremes (e.g., direct sunlight in an enclosed vehicle, near a heating duct, on top of heat-generating equipment); or are
 -  Damp (e.g., baths, washrooms, on wet floors); or are
 - Humid; or are
 - Exposed to rain; or are
 - Dusty; or are
 - Subject to high levels of vibration.

WARNING

- 008c** Be sure to use only the AC adaptor supplied with the unit. Also, make sure the line voltage at the installation matches the input voltage specified on the AC adaptor's body. Other AC adaptors may use a different polarity, or be designed for a different voltage, so their use could result in damage, malfunction, or electric shock. 

- 009** Do not excessively twist or bend the power cord, nor place heavy objects on it. Doing so can damage the cord, producing severed elements and short circuits. Damaged cords are fire and shock hazards! 

- 010** This unit, either alone or in combination with an amplifier and headphones or speakers, may be capable of producing sound levels that could cause permanent hearing loss. Do not operate for a long period of time at a high volume level, or at a level that is uncomfortable. If you experience any hearing loss or ringing in the ears, you should immediately stop using the unit, and consult an audiologist. 

- 011** Do not allow any objects (e.g., flammable material, coins, pins); or liquids of any kind (water, soft drinks, etc.) to penetrate the unit.  

⚠ WARNING

- 012c
- Immediately turn the power off, remove the AC adaptor from the outlet, and request servicing by your retailer, the nearest Roland Service Center, or an authorized Roland distributor, as listed on the "Information" page when: 
 - The AC adaptor or the power-supply cord has been damaged; or
 - Objects have fallen into, or liquid has been spilled onto the unit; or
 - The unit has been exposed to rain (or otherwise has become wet); or
 - The unit does not appear to operate normally or exhibits a marked change in performance.

- 012d
- Immediately turn the power off, and request servicing by your retailer, the nearest Roland Service Center, or an authorized Roland distributor, as listed on the "Information" page when: 
 - Objects have fallen into, or liquid has been spilled onto the unit; or
 - The unit has been exposed to rain (or otherwise has become wet); or
 - The unit does not appear to operate normally or exhibits a marked change in performance.

- 013
- In households with small children, an adult should provide supervision until the child is capable of following all the rules essential for the safe operation of the unit. 

- 014
- Protect the unit from strong impact. (Do not drop it!) 

- 015
- Do not force the unit's power-supply cord to share an outlet with an unreasonable number of other devices. Be especially careful when using extension cords—the total power used by all devices you have connected to the extension cord's outlet must never exceed the power rating (watts/amperes) for the extension cord. Excessive loads can cause the insulation on the cord to heat up and eventually melt through. 

- 016
- Before using the unit in a foreign country, consult with your retailer, the nearest Roland Service Center, or an authorized Roland distributor, as listed on the "Information" page. 

⚠ WARNING

- 023
- DO NOT play a CD-ROM disc on a conventional audio CD player. The resulting sound may be of a level that could cause permanent hearing loss. Damage to speakers or other system components may result. 

⚠ CAUTION

- 101b
- The unit and the AC adaptor should be located so their location or position does not interfere with their proper ventilation. 

- 102d
- Always grasp only the plug or the body of the AC adaptor when plugging into, or unplugging from, an outlet or this unit. 

- 103b
- Whenever the unit is to remain unused for an extended period of time, disconnect the AC adaptor. 

- 104
- Try to prevent cords and cables from becoming entangled. Also, all cords and cables should be placed so they are out of the reach of children. 

- 106
- Never climb on top of, nor place heavy objects on the unit. 

- 107d
- Never handle the AC adaptor body, or its plugs, with wet hands when plugging into, or unplugging from, an outlet or this unit. 

- 108b
- Before moving the unit, disconnect the AC adaptor and all cords coming from external devices. 

- 108c
- Disconnect all cords coming from external devices before moving the unit. 

- 109b
- Before cleaning the unit, turn off the power and unplug the AC adaptor from the outlet. 

- 110b
- Whenever you suspect the possibility of lightning in your area, disconnect the AC adaptor from the outlet. 

- 118
- Should you remove the optical connector caps, make sure to put them in a safe place out of children's reach, so there is no chance of them being swallowed accidentally. 

IMPORTANT NOTES

291a

In addition to the items listed under “USING THE UNIT SAFELY” on page **, please read and observe the following:

Power Supply

301

- Do not use this unit on the same power circuit with any device that will generate line noise (such as an electric motor or variable lighting system).

302

- The AC adaptor will begin to generate heat after long hours of consecutive use. This is normal, and is not a cause for concern.

307

- Before connecting this unit to other devices, turn off the power to all units. This will help prevent malfunctions and/or damage to speakers or other devices.

Placement

351

- Using the unit near power amplifiers (or other equipment containing large power transformers) may induce hum. To alleviate the problem, change the orientation of this unit; or move it farther away from the source of interference.

352a

- This device may interfere with radio and television reception. Do not use this device in the vicinity of such receivers.

352b

- Noise may be produced if wireless communications devices, such as cell phones, are operated in the vicinity of this unit. Such noise could occur when receiving or initiating a call, or while conversing. Should you experience such problems, you should relocate such wireless devices so they are at a greater distance from this unit, or switch them off.

354a

- Do not expose the unit to direct sunlight, place it near devices that radiate heat, leave it inside an enclosed vehicle, or otherwise subject it to temperature extremes. Excessive heat can deform or discolor the unit.

355

- To avoid possible breakdown, do not use the unit in a wet area, such as an area exposed to rain or other moisture.

Maintenance

401a

- For everyday cleaning wipe the unit with a soft, dry cloth or one that has been slightly dampened with water. To remove stubborn dirt, use a cloth impregnated with a mild, non-abrasive detergent. Afterwards, be sure to wipe the unit thoroughly with a soft, dry cloth.

402

- Never use benzine, thinners, alcohol or solvents of any kind, to avoid the possibility of discoloration and/or deformation.

Additional Precautions

553

- Use a reasonable amount of care when using the unit's buttons, sliders, or other controls; and when using its jacks and connectors. Rough handling can lead to malfunctions.

556

- When connecting / disconnecting all cables, grasp the connector itself—never pull on the cable. This way you will avoid causing shorts, or damage to the cable's internal elements.

558a

- To avoid disturbing your neighbors, try to keep the unit's volume at reasonable levels. You may prefer to use headphones, so you do not need to be concerned about those around you (especially when it is late at night).

559a

- When you need to transport the unit, package it in the box (including padding) that it came in, if possible. Otherwise, you will need to use equivalent packaging materials.

562

- Use a cable from Roland to make the connection. If using some other make of connection cable, please note the following precautions.
 - Some connection cables contain resistors. Do not use cables that incorporate resistors for connecting to this unit. The use of such cables can cause the sound level to be extremely low, or impossible to hear. For information on cable specifications, contact the manufacturer of the cable.

Handling CD-ROMs

801

- Avoid touching or scratching the shiny underside (encoded surface) of the disc. Damaged or dirty CD-ROM discs may not be read properly. Keep your discs clean using a commercially available CD cleaner.

Contents

USING THE UNIT SAFELY	3
IMPORTANT NOTES	5
Features of the SD-20	7
Check the contents of the package.....	8
Names of things and what they do.....	9
Front Panel	9
Rear Panel	10
Exchanging MIDI data with your computer.....	11
Basic connections	12
About the sound generator modes	13
About parts and sounds.....	15
Different types of part	15
Polyphony and voices	15
Getting connected and installing drivers (Windows)	16
USB connection.....	17
Serial connection	28
Settings and checking.....	38
Background service	
?.....	40
Checking for sound output.....	41
Getting connected and installing drivers (Macintosh)	42
USB connection.....	43
Serial connection	50
Troubleshooting.....	57
Problems related to the USB driver.....	57
Problems when using the SD-20	62
Deleting the driver.....	64
Serial MIDI driver settings	66
Uninstalling the serial MIDI driver	69

Features of the SD-20

32-part, 64-voice polyphony

Complete studio module including 32-part MIDI synthesizer and 64-voice polyphony for computer music, karaoke, huge orchestrations and more....

GM2/GS/XGlite 660 tones, 23 drum sets

The standard GM2/GS/XGlite compatible sound selections provide a variety of music genres such as classical, contemporary, pop and beyond... Play the realistic instruments tones from Grand Pianos, Rippin' Guitars, Jazzy Sax and ethnic drums!!

Optical Digital Output (S/P DIF)

Optical digital connection allows for exceptional MIDI sound quality output not found on any sound module in its price range.



USB bus powered, adaptor free

USB connection supplies power as well as data. The convenience of having all the mobile elements of music production.

Easy connection to computer (Serial / USB)

Legacy compatible with serial computers or simply connect through USB for Mac or PC.

ADD

* XG () and XGlite () are trademarks of YAMAHA Corporation.

203

* GS () is a registered trademark of Roland Corporation.

204

* Microsoft and Windows are registered trademarks of Microsoft Corporation.

206c

* Windows® 98 is known officially as: "Microsoft® Windows® 98 operating system."

206e

* Screen shots in this documents are reprinted with permission from Microsoft Corporation.

206f

* Windows® 2000 is known officially as: "Microsoft® Windows® 2000 operating system."

206g

* Windows® Me is known officially as: "Microsoft® Windows® Millennium Edition operating system."

ADD

* Windows® XP is known officially as: "Microsoft® Windows® XP operating system."

207

* Apple and Macintosh are registered trademark of Apple Computer, Inc.

209

* MacOS is a trademark of Apple Computer, Inc.

220

* All product names mentioned in this document are trademarks or registered trademarks of their respective owners.

231

* OMS is a registered trademark of Opcode Systems, Inc.

232

* FreeMIDI is a trademark of Mark of the Unicorn, Inc.

Check the contents of the package

The following items are included in the SD-20 package. After opening the package, check to see whether any items are missing. If any items are missing, please contact the dealer from whom you purchased the SD-20.

* *The SD-20 package does not include an external amp or speakers, or headphones. You will need to provide these separately.*

MEMO

You may want to mark the relevant check box as you confirm the presence of each item.



MEMO

For details on General MIDI 2, GS format, and XGlite, please refer to the SD-20 owner's manual.

SD-20

This is a **Studio Canvas** unit with USB audio interface. It supports **General MIDI 2, GS format** (the universal specification for Roland sound generators), and the **XGlite** promoted by Yamaha Corporation.



AC adaptor

This is the only AC adaptor you should use with the SD-20. Do not use any AC adaptor other than the supplied one, since doing so may cause malfunction.

CD-ROM

This contains drivers used by the SD-20, and demo songs. On the disc, you'll also find PDF files containing detailed information that should prove helpful if you intend to make full use of the SD-20's advanced functionality.

MEMO

Avoid touching or scratching the shiny underside (encoded surface) of the disc. Damaged or dirty CD-ROM discs may not be read properly. Keep your discs clean using a commercially available CD cleaner.



DO NOT play a CD-ROM disc on a conventional audio CD player. The resulting sound may be of a level that could cause permanent hearing loss. Damage to speakers or other system components may result.



USB cable

Conversion cable

Stereo miniature phone type <-> RCA phono type

Owner's Manual

This is the manual you are holding. Please read this first. This manual explains how to install the drivers and make the settings required in order to use the SD-20. Please read the sections that are relevant to your system.

Names of things and what they do

Front Panel

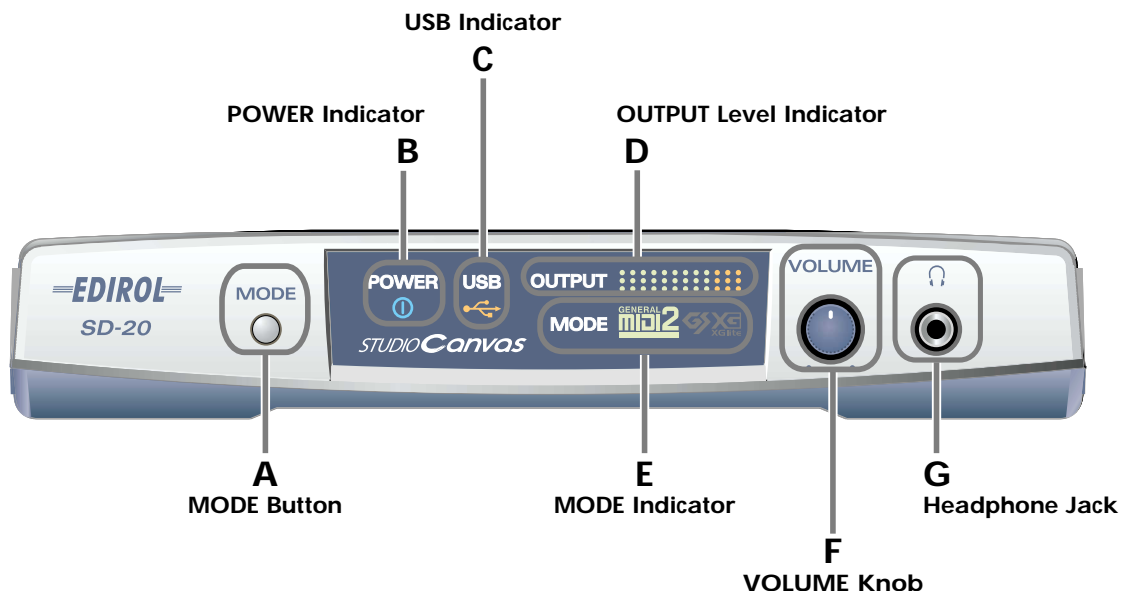

A. MODE Button

The sound-module mode changes each time you press this button. (->About the sound generator modes (p. 13))

Order of selection

Native mode (at power-up) -> GM2 -> GS -> XGlite

B. POWER Indicator

Lights in blue when the power is on.

C. USB Indicator

Lights in orange when data can be transmitted or received via USB.

D. OUTPUT Level Indicator

This will light in four stages to indicate the output level of the sound module.

E. MODE Indicator

This indicates the sound-module mode that's been selected using the **MODE** button.

F. VOLUME Knob

This adjusts the volume that is output from the **headphone jack** and the **OUTPUT jacks**.

G. Headphone Jack

A set of headphones can be connected to this jack.

Sound will still be output from the **OUTPUT jacks** even if headphones are connected.

Rear Panel

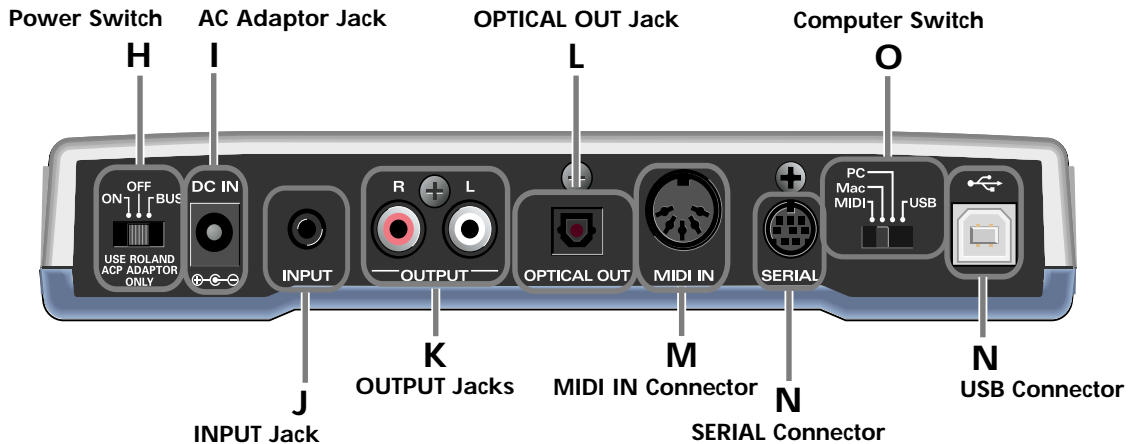

H. Power Switch

Provides for selection of either ON, OFF, or BUS as the setting for the power supply.

BUS POWER

The SD-20 can be operated on bus power.

"**Bus power**" refers to power that is supplied to the SD-20 from a computer via a USB cable. In this case, it is not necessary to connect the AC adaptor.

* *Depending on the manner in which your computer supplies power to the USB connector, you may not be able to run the SD-20 on bus power. In this case, please use the supplied AC adaptor.*

I. AC Adaptor Jack

Connect the supplied AC adaptor to this jack.

J. INPUT Jack

Connect the audio output jack of your computer sound card or audio device to this jack. The sound that is input here will be mixed with the sound of the SD-20, and output from the **OUTPUT jacks** and the **headphone jack**.

K. OUTPUT JACKS

These jacks output the sound produced by the SD-20 sound generator in combination with the sound that is input through the **INPUT jack**.

L. OPTICAL OUT Jack

This jack outputs the sound of the SD-20 sound generator. Sound being input through the **INPUT jack** will not be mixed in.

M. MIDI IN Connector

Connect your MIDI keyboard or MIDI controller to this connector.

N. SERIAL Connector

Use this connector if you want to connect the SD-20 to your computer via a computer cable.

O. Computer Switch

Set this switch as appropriate for the computer or interface to which the SD-20 is connected.

- * If you change the setting of the computer switch, the SD-20 must be restarted. Turn the SD-20's power switch OFF, then ON again.

USB	If using a USB connection
Mac	If using a serial connection to Macintosh
PC	If using a serial connection to Windows
MIDI	If connected to an external MIDI device

P. USB Connector

Use this connector if you want to connect the SD-20 to your computer via a USB cable.

Exchanging MIDI data with your computer

There are three ways to connect the SD-20 to your computer and play it.

Method	Number of available parts
Using the USB connector	Maximum 32 parts
Using the serial connector	Maximum 32 parts
Using the MIDI connector	Maximum 16 parts

- * Your computer needs to be equipped with a MIDI interface board or adaptor if you intend to use the MIDI connector

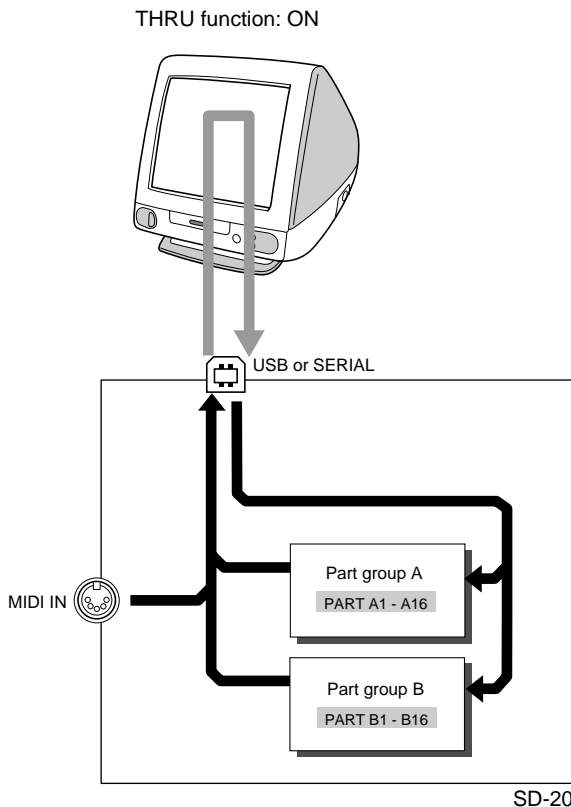

The number of sound generator parts that can be controlled will depend on your software. Refer to the owner's manual for the software you are using.

Basic connections

- * To prevent malfunction and/or damage to speakers or other devices, always turn down the volume, and turn off the power on all devices before making any connections.
- * To avoid short circuits or broken connections, grasp the plug when disconnecting a cable.
- * Use the included cables to make connections. If you are using a connection cable made by another manufacturer, please note the following.
 - Some connection cables contain a resistor. Do not use a cable with a built-in resistor to connect with the SD-90. Doing so may make the sound extremely weak, or inaudible. For details on your cable, please contact its manufacturer.

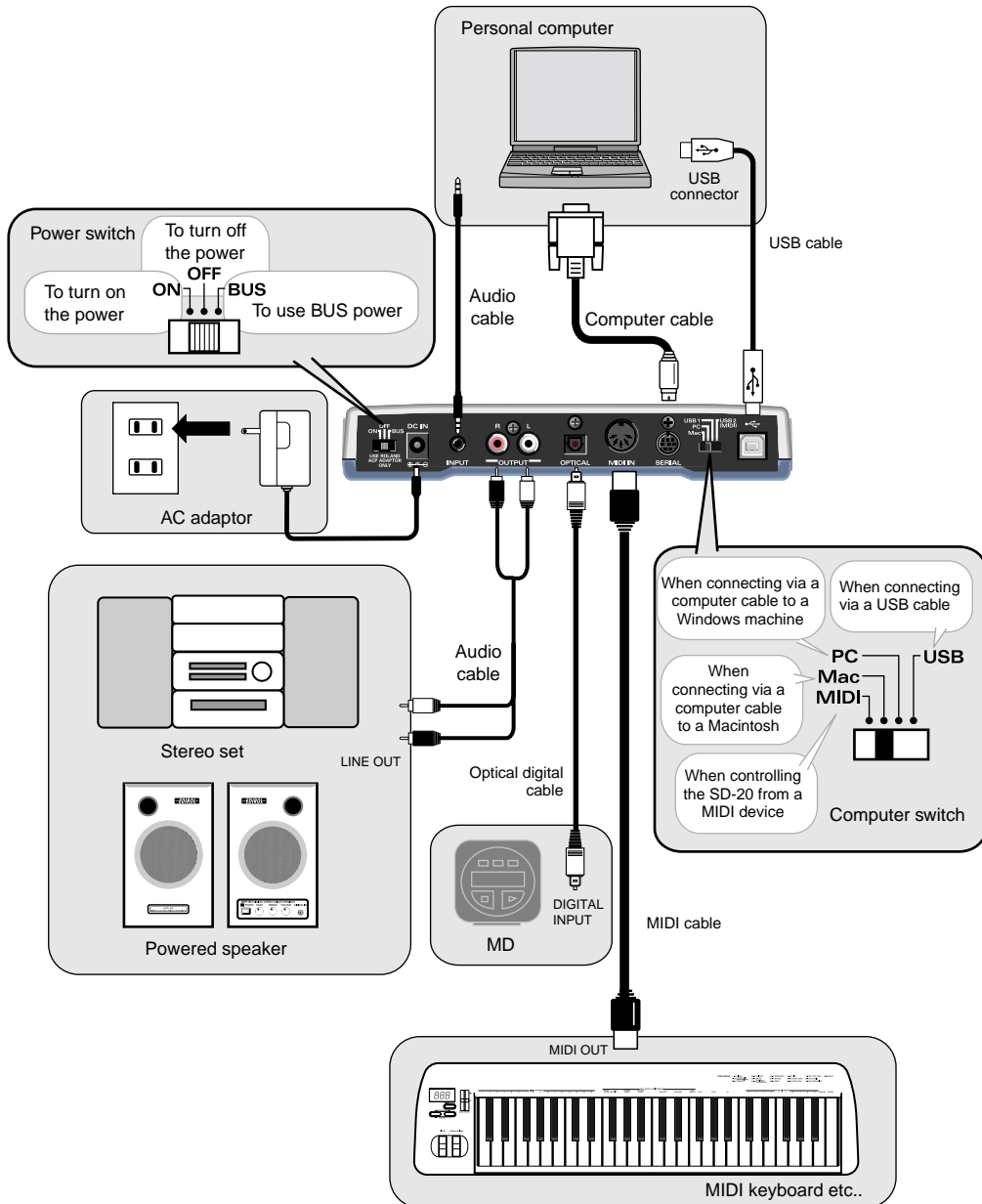

About the sound generator modes

The SD-20 has four sound generator modes: Native, GM2, GS, and XGlite. GM2 and Native modes offer three sound sets.

■ Native mode

This mode is unique to the SD-20. It provides three sound sets that can be switched using MIDI bank select messages.

The way in which sounds are selected is different than in GM2 mode. For this reason, song data you create in Native mode will not play back correctly on GM2 sound modules other than the SD-20.

Other functions are the same as in GM2 mode.

Sound sets in GM2/Native modes

The sound sets in GM2 mode and Native mode consist of three variations, which are classified according to their characteristics.

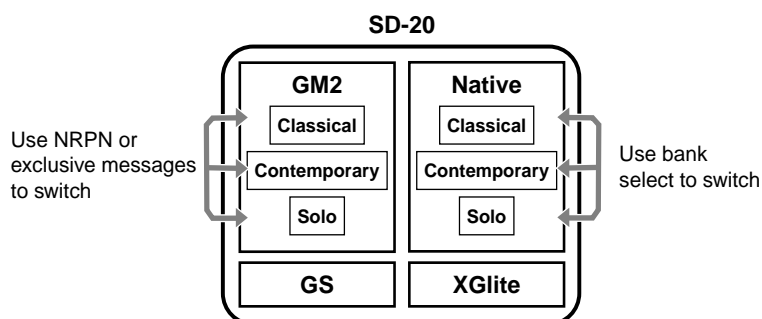

Classical

This is the basic sound set that blends well into an ensemble. This set is also used when GM2 data compatibility is important.

Contemporary

This sound set emphasizes the realism of each individual instrument. It contains numerous sounds that use velocity switching for expressive dynamics.

Solo

This sound set contains mainly sounds that are designed to be distinctive when used to play solos. These sounds include spacious stereo-sampled sounds, as well as sounds that are switched by velocity.

■ GM2 mode

This sound generator mode is compatible with the “GM2” sound generator format. GM2 is “recommended practice,” and it is backwardly compatible with GM. It was created in order to allow more sophisticated performance expression and greater compatibility. It includes detailed definitions concerning sound editing and the use of effects (things that weren’t covered by the earlier GM format), and it also expands the sound set. GM2-compatible sound generators will correctly play back music data bearing either the GM or GM2 logos. When it is necessary to make a distinction, this manual will sometimes refer to “GM1” to indicate the earlier GM format which does not include the extended specifications of GM2.

■ GS mode

This sound generator mode supports the “GS” sound generator format promoted by Roland Corporation. In addition to the General MIDI functionality, this format expands the sound set, and also enhances compatibility by providing detailed specifications for functionality such as sound editing and effects (reverb and chorus). For flexibility in meeting future needs, it also provides for the addition of new sounds and expanded functionality. Since the GS format is compatible with GM, it allows GM scores to be played in the same way as GS music data (music data created in conformity with the GS format).

* *It is not possible to edit GS mode sound generator parameters from the panel of the SD-20.*

■ XGlite mode

XG is a sound generator format promoted by Yamaha Corporation, which is based on GM1 (General MIDI 1). It provides detailed specifications concerning expansion of the sound sets, editing methods, and effects structures and types.

XGlite is a reduced-functionality (“lite”) version of XG, which allows simple playback of XG music data on a sound generator bearing the XGlite logo. Since XGlite has some limitations on the parameters and effects that can be controlled, the XG music data may sound different than the original data.

* *It is not possible to edit XGlite mode sound generator parameters from the panel of the SD-20.*

About parts and sounds

The SD-20 is able to produce 32 different sounds at once. A sound generator such as the SD-20 that is able to produce many different sounds simultaneously is called a “**multitimbral sound module**.” “Timbre” refers to the unique characteristics that result in the sound of one instrument being different from that of another. The ability to simultaneously produce 32 different instrument sounds means that, using the analogy of an orchestra, you can produce an ensemble consisting of 32 different instrumental parts. On the SD-20, the sound produced by each part is called an **Instrument** (“**Instrument list (GM2 / Native mode)**” (p. 72)). You can assign a desired instrument to each of the 32 parts, creating a 32-part ensemble.

Different types of part

The SD-20 has 32 parts, which are divided into groups A and B. Each group is numbered from 01-16; i.e., A01-A16 and B01-B16.

Each part can be set either as an **Inst part** or a **Drum part**. Inst parts are used to play melody, bass, etc. Drum parts are used to play percussion-type sounds. This setting is called the **Part Mode**.

By default, the following part mode is selected for each part.

Part mode	Corresponding parts
Inst part	A01-09, A11-16, B01-09, B11-16
Drum part	A10, B10

When using the MIDI connector to play the SD-20

When using the MIDI connector to play the SD-20, MIDI IN is correlated with Group A.

In other words, the MIDI messages received at MIDI IN will be passed to the Group A parts.

For example, MIDI messages arriving on channel 5 at MIDI IN will sound part 5 of group A (A05) (at the default settings). When using the MIDI IN connector to play the SD-20, it is not possible to play the Group B parts.

Polyphony and voices

Each of the SD-20's sounds consist of units called “**voices**.” There is a limit to the number of voices that can be used, and the SD-20 is able to use **64 voices** simultaneously. Some sounds (instruments) use more than one voice (“**Instrument list (GM2 / Native mode)**” (p. 72)). The main reason that an instrument uses some voices is so that velocity can be used to shift between different sounds, or so that multiple sounds can be layered to create a richer tone.

When you attempt to play more than **64** voices on the SD-20, the most-recently played note will be given priority, and the oldest of the currently-sounding notes will be turned off one by one. If you are using only instruments that consist of only one voice, you will be able to play 64 notes simultaneously. However, if you use instruments that consist of two or four voices, fewer than 64 notes can be played simultaneously. Even if a MIDI note-off message is received, a voice will continue to be used as long as that note continues to sound. You need to remain aware of this, particularly when using sounds that have a long release time.

Getting connected and installing drivers (Windows)

What is a driver?

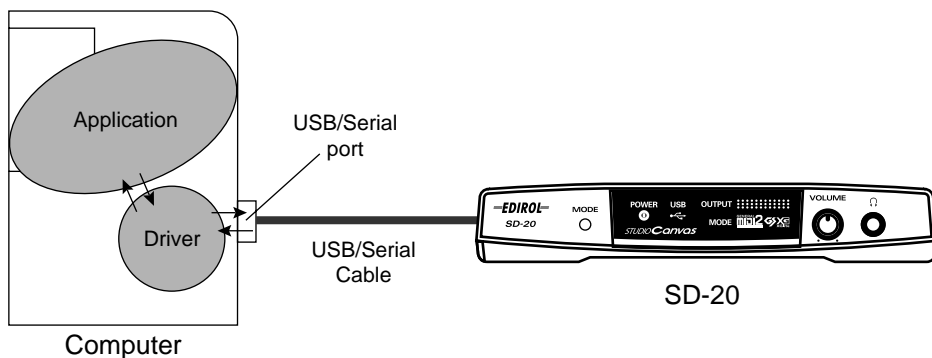

A “driver” is software that transfers data between the SD-20 and application software running on your computer, when your computer and the SD-20 are connected by a USB cable. The driver sends data from your application to the SD-20, and from the SD-20 to your application.

The SD-20 is able to operate using the “**BUS power**” that is supplied via the USB cable. This means that the supplied AC adaptor is not necessary.

However, if you are using a USB hub, or if not enough power can be supplied via USB, the SD-20 may not operate correctly. In this case, connect the supplied AC adaptor power supply to the SD-20.

When installing the driver, you must connect the AC adaptor and turn the POWER switch ON.

Which type of connection?

You can either use the USB cable, or use the computer cable to make a serial connection. Depending on the type of connection you are using, install the appropriate driver and make the appropriate settings.

USB connection(p. 17)

Serial connection(p. 28)

USB connection

The following items are required for connections and installation. Please have the following items ready.

- SD-20
- AC adaptor
- USB cable
- CD-ROM

The installation procedure will differ depending on your system. Please proceed to one of the following sections, depending on the system you use.

- Windows XP users (p. 17)
- Windows 2000 users..... (p. 22)
- Windows Me/98 users (p. 26)

■ Windows XP users

1

With the SD-20 disconnected, start up Windows.

Disconnect all USB cables except for a USB keyboard and USB mouse (if used).

2

Open the **System Properties** dialog box.

1. Click the Windows **Start** menu, and from the menu, select **Control Panel**.
2. In "Pick a category," click "**Performance and Maintenance**."
3. In "or pick a Control Panel icon," click the **System** icon.

3

Open the **Driver Signing Options** dialog box.

Click the **Hardware** tab, and then click [**Driver Signing**].

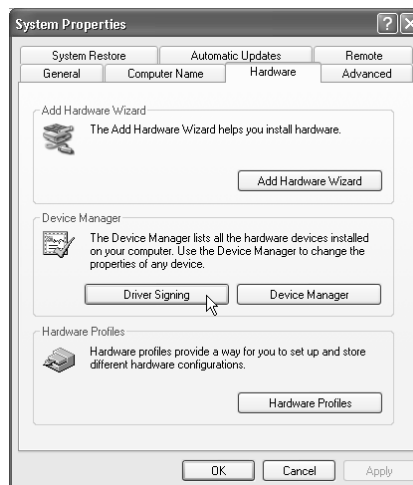

NOTE

If you are using Windows XP Professional, you must log on using a user name with an administrative account type (e.g., Administrator). For details on user accounts, please consult the system administrator of your computer.

MEMO

Depending on how your system is set up, the **System** icon may be displayed directly in the **Control Panel** (the Classic display). In this case, double-click the System icon.

4

Make sure that “**What action do you want Windows to take?**” is set to “**Ignore.**”

If it is set to “**Ignore**”, simply click **[OK]**.

If it is not set to “**Ignore**”, make a note of the current setting (“**Warn**” or “**Block**”). Then change the setting to “**Ignore**” and click **[OK]**



5

Close the **System Properties** dialog box.

Click **[OK]**.

6

Exit all currently running software (applications).

Also close any open windows. If you are using virus checking or similar software, be sure to exit it as well.

7

Prepare the CD-ROM.

Insert the CD-ROM into the CD-ROM drive of your computer.

8

Open the “**Run...**” dialog box.

Click the Windows **start** button. From the menu that appears, select “**Run...**”

9

In the dialog box that appears, input the following into the “**Open**” field, and click **[OK]**.

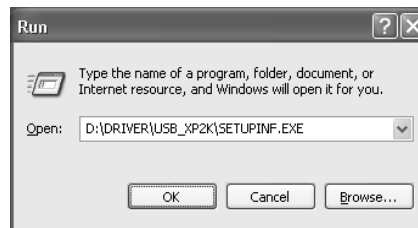

D:\DRIVER\USB_XP2K\SETUPINF.EXE

* The drive name “**D:**” may be different for your system. Specify the drive name of your CD-ROM drive.

MEMO

If you changed “**What action do you want Windows to take?**” in step 4, you must restore the previous setting after you have installed the driver. (->If you changed “**What action do you want Windows to take?**” (p. 21))

MEMO

In this manual, the location of folders and files is given in terms of the file path, using \ as the delimiter. For example, **USB_XP2K\SETUPINF.EXE** indicates the **SETUPINF.EXE** file found in the **USB_XP2K** folder.

10

The **SetupInf** dialog box will appear.

You are now ready to install the driver.

* *Do not click [OK] at this time.*

11

Connect the SD-20.

1. Set the **computer switch** of the SD-20 to **USB**.
2. With the **SD-20's power switch turned off**, connect it to the **AC adaptor**.
3. Plug the **AC adaptor** into an AC power outlet.
4. Use the **USB cable** to connect the **SD-20** to your **computer**.

12

Set the SD-20's power switch to the ON position.

Near the task bar, your computer will indicate "**Found New Hardware.**" Please wait.

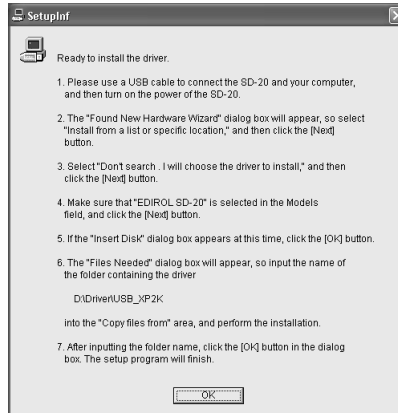
**MEMO**

If a message of "**The driver is already installed**" appears, you can connect the SD-20 to your computer and use it.

NOTE

Even if you will normally be using the SD-20 with BUS power, please use the AC adaptor while you are installing the driver and making settings.

MEMO

This unit is equipped with protection circuit. A brief interval (a few seconds) after power up is required before the unit will operate normally.

If in step 4 the "**What action do you want Windows to take?**" setting was not set to "Ignore", a "Digital signature not found" dialog box will appear.

If "**What action do you want Windows to take?**" is set to "Warn,"

1. Click [Continue Anyway].
2. Continue the installation.

If "**What action do you want Windows to take?**" is set to "Block"

1. Click [OK].
2. When the "**Found New Hardware Wizard**" appears, click [Finish].
3. Perform the installation as described in the "**Troubleshooting**" section on **Device Manager** shows "?", "!", or "**USB Composite Device**" (p. 60).



13 The **Found New Hardware** wizard will appear.

Make sure that the screen indicates “**EDIROL SD-20**,” select “**Install from a list or specific location (Advanced)**,” and click [**Next**].



14 The screen will indicate “**Please choose your search and installation options.**”

Select “**Don't search. I will choose the driver to install,**” and click [**Next**].



15 Make sure that the “**Model**” field indicates “**EDIROL SD-20**,” and click [**Next**]. Driver installation will begin.



16 The **Insert Disk** dialog box will appear.
Click [**OK**].

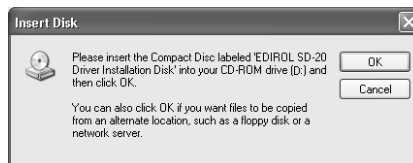

17

The **Files Needed** dialog box will appear.

In the "**Copy files from**" area, type "**D:\DRIVER\USB_XP2K**" and click [**OK**].

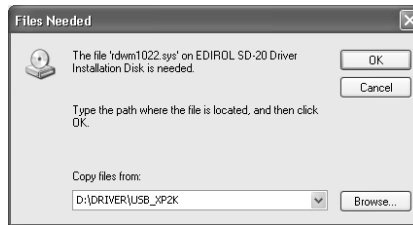
**18**

The **Found New Hardware** wizard will appear.

Make sure that the display indicates "**EDIROL SD-20**," and click [**Finish**].

Wait until "**Found New Hardware**" appears near the taskbar.

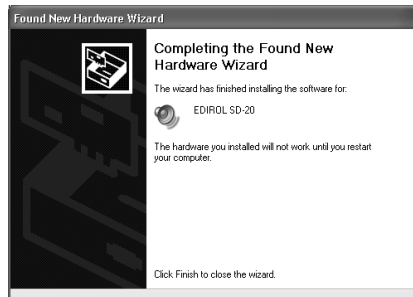
**19**

Restart Windows.

When driver installation has been completed, the **System Setting Change** dialog box will appear. Click [**Yes**].

If you changed "What action do you want Windows to take?"

If you changed the **What action do you want Windows to take?** setting in step 5, restore the original setting after Windows restarts.

1. If you are using Windows XP Professional, log on to Windows using the user name of an administrative account (e.g., Administrator).
2. Click the Windows **start** menu, and from the menu, select **Control Panel**.
3. In "**Pick a category**," click "**Performance and Maintenance**."
4. In "**or pick a Control Panel icon**," click the **System** icon. The System Properties dialog box will appear.
5. Click the **Hardware** tab, and then click [**Driver Signing**]. The **Driver Signing Options** dialog box will appear.
6. Return the **What action do you want Windows to take?** setting to the original setting (either "Warn" or "Block"), and click [**OK**].
7. Click [**OK**]. The **System properties** dialog box will close.

Nest, you need to make the driver settings.
(-> **Settings and checking** (p. 38))

■ Windows 2000 users

- 1 With the SD-20 disconnected, start up Windows.
Disconnect all USB cables except for a USB keyboard and USB mouse (if used).
- 2 Log on to Windows as a **user with administrative privileges** (such as Administrator).
- 3 Open the **System Properties** dialog box.
Click the Windows **Start** button, and from the menu that appears, select **Settings | Control Panel**. In **Control Panel**, double-click the **System** icon.
- 4 Open the **Driver Signing Options** dialog box.
Click the **Hardware** tab, and then click **[Driver Signing]**.

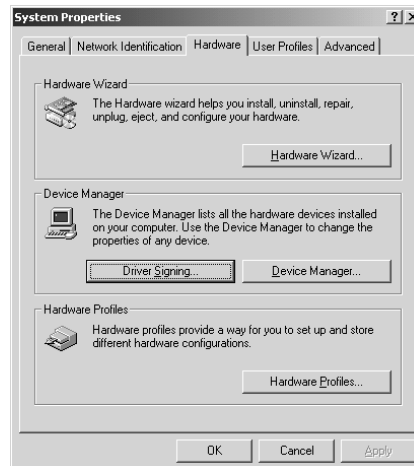

- 5 Make sure that “**File signature verification**” is set to “**Ignore**.”
If it is set to “**Ignore**”, simply click **[OK]**.
If it is not set to “**Ignore**”, make a note of the current setting (“**Warn**” or “**Block**”). Then change the setting to “**Ignore**” and click **[OK]**.



- 6 Close the **System Properties** dialog box.
Click **[OK]**.

MEMO

If you changed the “File signature verification” setting in step 5, restore the original setting after Windows restarts. (->If you changed “File signature verification” (p. 25))

7

Exit all currently running software (applications).

Also close any open windows. If you are using virus checking or similar software, be sure to exit it as well.

8

Prepare the CD-ROM.

Insert the CD-ROM into the CD-ROM drive of your computer.

9

Open the “Run...” dialog box.

Click the Windows **Start** button. From the menu that appears, select “Run...”

10

In the dialog box that appears, input the following into the “Open” field, and click [OK].



D:\DRIVER\USB_XP2K\SETUPINF.EXE

* The drive name “D:” may be different for your system. Specify the drive name of your CD-ROM drive.

11

The **SETUPINF** dialog box will appear.

You are now ready to install the driver.

* Do not click [OK] at this time.

**12**

Connect the SD-20.

1. Set the **computer switch** of the SD-20 to **USB**.
2. With the **SD-20's power switch turned off**, connect it to the **AC adaptor**.
3. Plug the **AC adaptor** into an AC power outlet.
4. Use the **USB cable** to connect the **SD-20** to your **computer**.

13

Set the SD-20's **power switch** to the **ON** position.

MEMO

In this manual, the location of folders and files is given in terms of the file path, using \ as the delimiter. For example, **USB_XP2K\SETUPINF.EXE** indicates the **SETUPINF.EXE** file found in the **USB_XP2K** folder.

NOTE

Even if you will normally be using the SD-20 with BUS power, please use the AC adaptor while you are installing the driver and making settings.

MEMO

This unit is equipped with protection circuit. A brief interval (a few seconds) after power up is required before the unit will operate normally.

If in **step 5** the “**File signature verification**” setting was not set to “**Ignore**”, a “**Digital signature not found**” dialog box will appear.

If “File signature verification” is set to “Warn,”

1. Click **[Yes]**.
2. Continue the installation.

If “File signature verification” is set to “Block”

1. Click **[OK]**.
2. When the “**New hardware detection wizard**” appears, click **[Finish]**.
3. Perform the installation as described in the “**Troubleshooting**” section on **Device Manager** shows “**?**”, “**!**”, or “**USB Composite Device**” (p. 60).



14 The **Insert Disk** dialog box will appear.

Click **[OK]**.

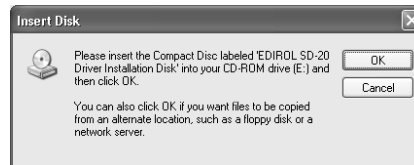

NOTE

If the Insert disk dialog box does not appear, please read **The “Insert Disk” dialog box does not appear** (p. 60)

15 The **Files Needed** dialog box will appear.

In the “**Copy files from**” area, type “**D:\DRIVER\USB_XP2K**” and click **[OK]**.

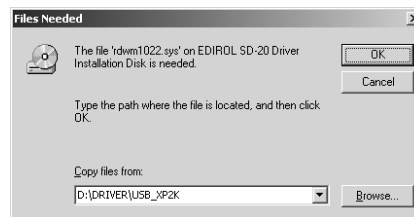

16 The “**Found New Hardware Wizard**” may be displayed.

Verify that “**EDIROL SD-20**” is displayed, and click **[Finish]**.

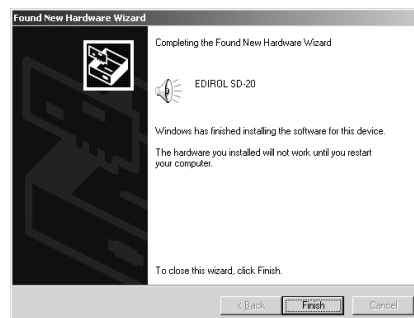

17

Restart Windows.

The **System Settings Change** dialog box may appear. Click **[Yes]**.
Windows will restart automatically.

If you changed “File signature verification”

If you changed the “File signature verification” setting in step 5, restore the original setting after Windows restarts.

1. After Windows restarts, log in to Windows as a user with **administrative privileges**, (such as Administrator).
2. In the Windows desktop, right-click the **My Computer** icon, and from the menu that appears, select **Properties**. The **System Properties** dialog box will appear.
3. Click the **Hardware** tab, and then click **[Driver signature]**. The **Driver Signing Options** dialog box will appear.
4. Return the “**File signature verification**” setting to the original setting (either “**Warn**” or “**Block**”), and click **[OK]**.
5. Click **[OK]**. The **System properties** dialog box will close.

Nest, you need to make the driver settings.
(-> **Settings and checking** (p. 38))

■ Windows Me/98 users

1

With the SD-20 disconnected, start up Windows.

Disconnect all USB cables except for a USB keyboard and USB mouse (if used).

2

Exit all currently running software (applications).

Also close any open windows. If you are using virus checking or similar software, be sure to exit it as well.

3

Prepare the CD-ROM.

Insert the CD-ROM into the CD-ROM drive of your computer.

4

Open the “Run...” dialog box.

Click the Windows **Start** button.

From the menu that appears, select “Run...”

5

In the dialog box that appears, input the following into the “Open” field, and click [OK].



D:\DRIVER\USB_ME98\SETUPINF.EXE

* The drive name “D:” may be different for your system. Specify the drive name of your CD-ROM drive.

6

The **SETUPINF** dialog box will appear.

You are now ready to install the driver.

* Do not click [OK] at this time.

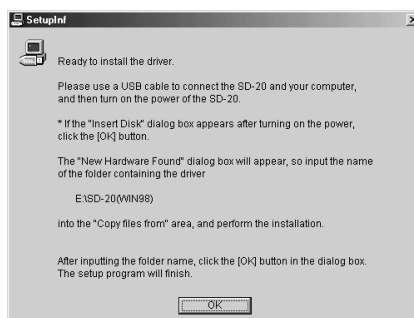

MEMO

In this manual, the location of folders and files is given in terms of the file path, using \ as the delimiter. For example, **USB_ME98\SETUPINF.EXE** indicates the **SETUPINF.EXE** file found in the **USB_ME98** folder.

7

Connect the SD-20.

1. Set the **computer switch** of the SD-20 to **USB**.
2. With the **SD-20's power switch turned off**, connect it to the **AC adaptor**.
3. Plug the **AC adaptor** into an AC power outlet.
4. Use the **USB cable** to connect the **SD-20** to your **computer**.

5

Set the SD-20's power switch to the **ON** position.

6

If you are using Windows 98, an **Insert Disk** dialog box will appear.

Click **[OK]**.



7

The **New Hardware Found** dialog box will appear.

In the "**Copy files from**" area, type "**D:\DRIVER\USB_ME98**" and click **[OK]**.



8

Once the driver has been installed, **New Hardware Found** dialog box will close.

In the **SETUPINF** dialog box, click **[OK]**. The **SETUPINF** dialog box will close.

Nest, you need to make the driver settings.
(-> **Settings and checking** (p. 38))

NOTE

Even if you will normally be using the SD-20 with BUS power, please use the AC adaptor while you are installing the driver and making settings.

MEMO

This unit is equipped with a protection circuit. A brief interval (a few seconds) after power up is required before the unit will operate normally.

NOTE

If you are using Windows 98 and the **Insert Disk** dialog box does not appear, please read **The "Insert Disk" dialog box does not appear** (p. 60).

NOTE

If the **New Hardware Found** dialog box does not appear, re-install the driver using the same procedure as described in **The "Insert Disk" dialog box does not appear** (p. 60).

Serial connection

The following items are required for connections and installation. Please have the following items ready.

- SD-20
- AC adaptor
- Computer cable
- CD-ROM

The installation procedure will differ depending on your system. Please proceed to one of the following sections, depending on the system you use.

- Windows XP users (p. 28)
- Windows 2000 users..... (p. 32)
- Windows Me/98 users (p. 36)

■ Windows XP users

- 1 Make sure that the power is turned off for the SD-20, your computer, and all peripheral devices.
- 2 Set the **computer switch** of the SD-20 to **PC**.
- 3 Use the computer cable to connect the serial connector of your computer to the SD-20.
- 4 With the **SD-20's power switch turned off**, connect it to the **AC adaptor**.
- 5 Plug the **AC adaptor** into an AC power outlet.
- 6 **Turn on** the power of the SD-20 and your computer, and start up Windows.
- 7 Open the **System Properties** dialog box.
 1. Click the Windows **start** menu, and from the menu, select **Control Panel**.
 2. In "Pick a category," click "**Performance and Maintenance**."
 3. In "or pick a Control Panel icon," click the **System** icon.

NOTE

If you are using Windows XP Professional, you must log on using a user name with an administrative account type (e.g., Administrator). For details on user accounts, please consult the system administrator of your computer.

MEMO

For details on connections, refer to **Basic connections** (p. 12)

MEMO

Depending on how your system is set up, the **System** icon may be displayed directly in the **Control Panel** (the Classic display). In this case, double-click the System icon.

8

Open the **Driver Signing Options** dialog box.

Click the **Hardware** tab, and then click **[Driver Signing]**.

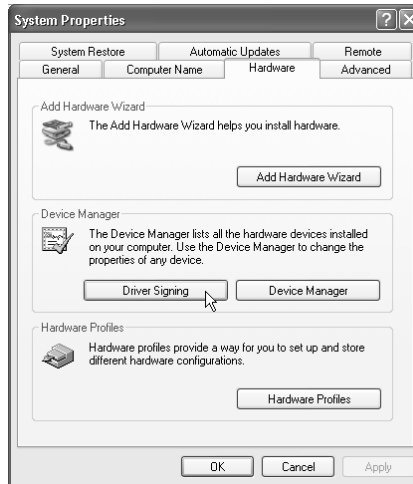

9

Make sure that “**What action do you want Windows to take?**” is set to “**Ignore.**”

If it is set to “**Ignore**”, simply click **[OK]**.

If it is not set to “**Ignore**”, make a note of the current setting (“**Warn**” or “**Block**”). Then change the setting to “**Ignore**” and click **[OK]**



If you changed “**What action do you want Windows to take?**” in step 8, you must restore the previous setting after you have installed the driver. (->If you changed “**What action do you want Windows to take?**” (p. 21))

10

Close the System Properties dialog box.

Click **[OK]**.

11

Exit all currently running software (applications).

Also close any open windows. If you are using virus checking or similar software, be sure to exit it as well.

12

Prepare the CD-ROM.

Insert the CD-ROM into the CD-ROM drive of your computer.

13

Open the “**Run...**” dialog box.

Click the Windows **start** button. From the menu that appears, select “**Run...**”

14

In the dialog box that appears, input the following into the “Open” field, and click [OK].

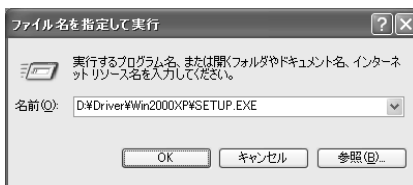

D:\DRIVER\SER_XP2K\SETUP.EXE

* The drive name “D:” may be different for your system. Specify the drive name of your CD-ROM drive.

15

The **Welcome** dialog box will appear.

Click [Next].

16

A dialog box like the following will appear.

Click [Next].

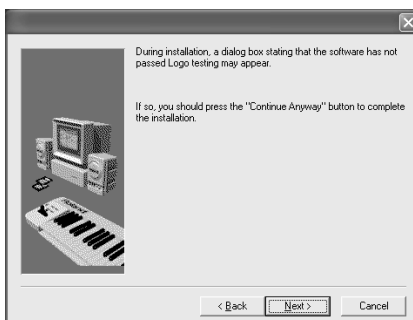

If in step 9 the “What action do you want Windows to take?” setting was not set to “Ignore”, a “Hardware Installation” dialog box will appear.

If “What action do you want Windows to take?” is set to “Warn,”

1. Click [Continue Anyway].
2. Continue the installation.

If “What action do you want Windows to take?” is set to “Block”

1. Click [OK].
2. When the “Found New Hardware Wizard” appears, click [Finish].
3. Perform the installation as described in the “Troubleshooting” section on **Device Manager** shows “?”, “!”, or “USB Composite Device” (p. 60).

**MEMO**

In this manual, the location of folders and files is given in terms of the file path, using \ as the delimiter. For example, **SER_XP2K\SETUP.EXE** indicates the **SETUP.EXE** file found in the **SER_XP2K** folder.

17

The **Roland Serial MIDI Driver Settings** dialog box will appear.

Set the following items. Click **[OK]**.

COM Ports

Select the serial port (COM port) to which the SD-20's serial port is connected.

Switches

Check "**Use multiple ports.**"

Click the ▼ symbol at the right of the **[Sound module]** field, and select **SD-20**.

* *Do not check "**Activate CTS/RTS Flow Control.**"*

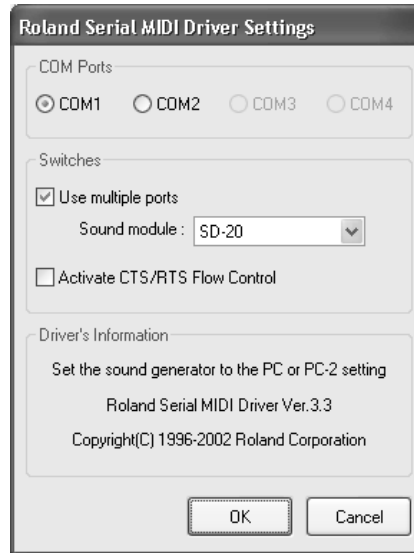
**18**

When driver installation has been completed, the **Restart your computer** dialog box will appear. Restart your computer.

If you changed "What action do you want Windows to take?"

If you changed the **What action do you want Windows to take?** setting in step 5, restore the original setting after Windows restarts.

1. If you are using Windows XP Professional, log on to Windows using the user name of an administrative account (e.g., Administrator).
2. Click the Windows **Start** menu, and from the menu, select **Control Panel**.
3. In "Pick a category," click "**Performance and Maintenance.**"
4. In "or pick a Control Panel icon," click the **System** icon. The System Properties dialog box will appear.
5. Click the **Hardware** tab, and then click **[Driver Signing]**. The **Driver Signing Options** dialog box will appear.
6. Return the **What action do you want Windows to take?** setting to the original setting (either "Warn" or "Block"), and click **[OK]**.
7. Click **[OK]**. The **System properties** dialog box will close.

Nest, you need to make the driver settings.

(-> **Settings and checking** (p. 38))

■ Windows 2000 users

- 1 Make sure that the power is turned off for the SD-20, your computer, and all peripheral devices.
- 2 Set the **computer switch** of the SD-20 to **PC**.
- 3 Use the computer cable to connect the serial connector of your computer to the SD-20.
- 4 With the **SD-20's power switch turned off**, connect it to the **AC adaptor**.
- 5 Plug the **AC adaptor** into an AC power outlet.
- 6 Turn on the power of the SD-20 and your computer, and start up Windows.
- 7 Open the **System Properties** dialog box.
 1. Click the Windows **Start** menu, and from the menu that appears, select **Settings | Control Panel**.
 2. In "**Control Panel**," double-click the **System** icon.

- 8 Open the **Driver Signing Options** dialog box.
Click the **Hardware** tab, and then click [**Driver Signing**].

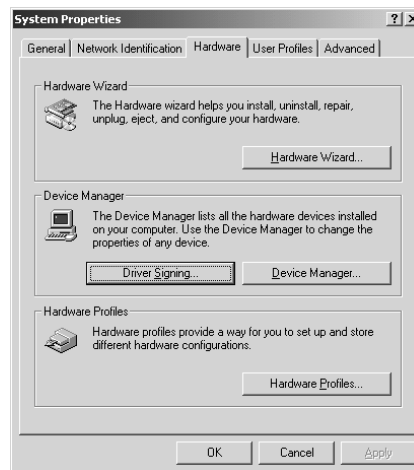

NOTE

Log on to Windows using a user name with an administrative account type (e.g., Administrator). For details on user accounts, please consult the system administrator of your computer.

MEMO

For details on connections, refer to "**Basic connections** (p. 12)."

9

Make sure that “**File signature verification**” is set to “**Ignore.**”

If it is set to “**Ignore**”, simply click **[OK]**.

If it is not set to “**Ignore**”, make a note of the current setting (“**Warn**” or “**Block**”). Then change the setting to “**Ignore**” and click **[OK]**.

**10**

Close the **System Properties** dialog box.

Click **[OK]**.

11

Exit all currently running software (applications).

Also close any open windows. If you are using virus checking or similar software, be sure to exit it as well.

12

Prepare the CD-ROM.

Insert the CD-ROM into the CD-ROM drive of your computer.

13

Open the “**Run...**” dialog box.

Click the Windows **Start** button.

From the menu that appears, select “**Run...**”

14

In the dialog box that appears, input the following into the “**Open**” field, and click **[OK]**.



D:\DRIVER\SER_XP2K\SETUP.EXE

* The drive name “**D:**” may be different for your system. Specify the drive name of your CD-ROM drive.

15

The **Welcome** dialog box will appear.

Click **[Next]**.

MEMO

In this manual, the location of folders and files is given in terms of the file path, using \ as the delimiter. For example, **SER_XP2K\SETUP.EXE** indicates the **SETUP.EXE** file found in the **SER_XP2K** folder.

16

A dialog box like the following will appear.

Click **[Next]**.

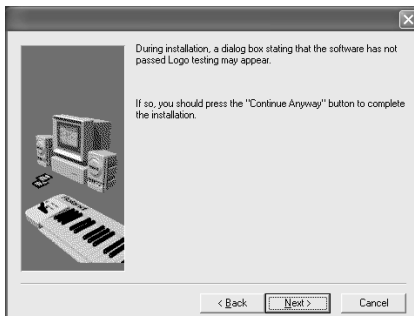

If in **step 7** the **“File signature verification”** setting was not set to **“Ignore”**, a **“Digital signature not found”** dialog box will appear.

If **“File signature verification”** is set to **“Warn,”**

1. Click **[Yes]**.
2. Continue the installation.

If **“File signature verification”** is set to **“Block”**

1. Click **[OK]**.
2. When the **“New hardware detection wizard”** appears, click **[Finish]**.
3. Perform the installation as described in the **“Troubleshooting”** section on **Device Manager** shows **“?”**, **“!”**, or **“USB Composite Device”** (p. 60).



4

The **Roland Serial MIDI Driver Settings** dialog box will appear.

Set the following items. Click **[OK]**.

COM Ports

Select the serial port (COM port) to which the SD-20's serial port is connected.

Switches

Check **“Use multiple ports.”**

Click the ▼ symbol at the right of the **[Sound module]** field, and select **SD-20**.

* *Do not check **“Activate CTS/RTS Flow Control.”***

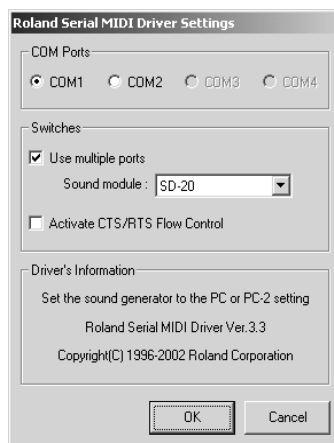

5

When driver installation has been completed, the **Restart your computer** dialog box will appear. Restart your computer.

If you changed “File signature verification”

If you changed the “File signature verification” setting in step 5, restore the original setting after Windows restarts.

1. After Windows restarts, log in to Windows as a user with **administrative privileges**, (such as Administrator).
2. In the Windows desktop, right-click the **My Computer** icon, and from the menu that appears, select **Properties**. The **System Properties** dialog box will appear.
3. Click the **Hardware** tab, and then click **[Driver signing]**. The **Driver Signing Options** dialog box will appear.
4. Return the “**File signature verification**” setting to the original setting (either “**Warn**” or “**Block**”), and click **[OK]**.
5. Click **[OK]**. The **System properties** dialog box will close.

Next, you need to make the driver settings.
(->**Settings and checking** (p. 38))

■ Windows Me/98 users

- 1 Make sure that the power is turned off for the SD-20, your computer, and all peripheral devices.
- 2 Set the **computer switch** of the SD-20 to **PC**.
- 3 Use the computer cable to connect the serial connector of your computer to the SD-20.
- 4 With the **SD-20's power switch turned off**, connect it to the **AC adaptor**.
- 5 Plug the **AC adaptor** into an AC power outlet.
- 6 Turn on the power of the SD-20 and your computer, and start up Windows.
- 7 Exit all currently running software (applications).
Also close any open windows. If you are using virus checking or similar software, be sure to exit it as well.
- 8 Prepare the CD-ROM.
Insert the CD-ROM into the CD-ROM drive of your computer.
- 9 Open the "Run..." dialog box.
Click the Windows **Start** button.
From the menu that appears, select "**Run...**"
- 10 In the dialog box that appears, input the following into the "Open" field, and click [OK].

D:\DRIVER\SER_ME98\DISK1\SETUP.EXE

* The drive name "D:" may be different for your system. Specify the drive name of your CD-ROM drive.
- 11 The **Welcome** dialog box will appear.
Click [Next].

MEMO

For details on connections, refer to "**Basic connections** (p. 12)."

MEMO

In this manual, the location of folders and files is given in terms of the file path, using \ as the delimiter. For example, **SER_ME98\SETUP.EXE** indicates the **SETUP.EXE** file found in the **SER_ME98** folder.

12 The **Select Port** dialog box will appear.

Select the serial port to which the SD-20 is connected, and click **[Next]**.

The number of COM ports will depend on your computer system.

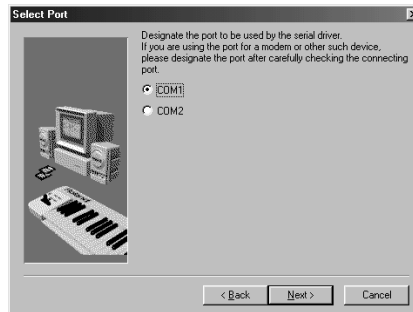

13 The **Select MIDI OUT Port Number** dialog box will appear.

Select SD-20, and click **[Next]**.

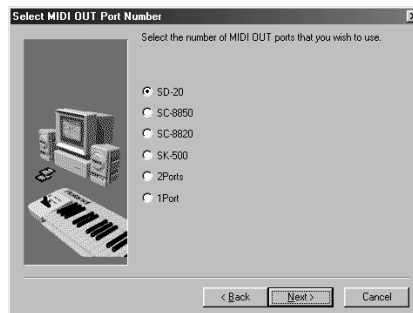

14 The **Installation information** dialog box will appear.

Check the displayed contents, and click **[Next]**.

15 The **Computer Switch Setting** dialog box will appear.

Make sure that the computer switch on the rear of the SD-20 is set to **[PC]**, and click **[Next]**.

If it is not set to **[PC]**, perform this procedure again from **step 1**.

16 When driver installation has been completed, the **Restart Computer** dialog box will appear. Restart your computer.

Nest, you need to make the driver settings.
(-> **Settings and checking** (p. 38))

Settings and checking

■ Windows XP/2000/Me users

1

Open **Control Panel**.

Click the Windows **Start** button, and from the menu that appears, select **Settings | Control Panel**.

Windows XP

Click the Windows **start** button, and from the menu that appears, select **Control Panel**.

2

Open the **Sounds and Multimedia Properties** dialog box (or in Windows XP, **Sounds and Audio Devices Properties**).

Windows 2000/Me

In **Control Panel**, double-click the **Sounds and Multimedia** icon to open the “**Sounds and Multimedia Properties**” dialog box.

Windows XP

In “**Pick a category**,” click “**Sound, Speech, and Audio Devices**.”

Next, in “**or pick a Control Panel icon**,” click the **sounds and Audio Devices** icon.

3

Click the **Audio** tab.

4

For **MIDI music playback**, click the ▼ located at the right of [**Preferred device**] (or in Windows XP, [**Default device**]), and select the following from the list that appears.

For a USB connection	EDIROL SD-20 PART A
For a serial connection	Roland Serial MIDI Out A



5

Click **OK** to complete the settings.

MEMO

Depending on how your system is set up, the **Sounds and Audio Devices** icon may be displayed directly in the **Control Panel** (the Classic display). In this case, double-click the **Sounds and Audio Devices** icon.

Proceed to the following page.

Windows XP users..... (p. 40)

Windows 2000/Me users..... (p. 41)

■ Windows 98 users

1

Open **Control Panel**.

Click the Windows **Start** button, and from the menu that appears, select **Settings | Control Panel**.

2

Open the **Multimedia Properties** dialog box.

In **Control Panel**, double-click the **Multimedia** icon to open the "**Multimedia Properties**" dialog box.

3

Click the **MIDI** tab.

4

Set "**MIDI output**."

Select [**Single instrument**], and choose one of the following from the list that appears.

For a USB connection	EDIROL SD-20 PART A
For a serial connection	Roland Serial MIDI Out A

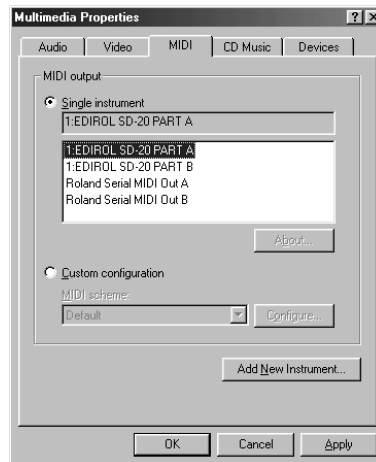

5

Click **OK** to complete the settings.

Proceed to the following page.
(-> **Checking for sound output** (p. 41))

Enabling background services

In Windows XP, perform these settings to make MIDI processing occur more smoothly. These settings are unavailable in Windows 2000/Me/98.

- 1 Click the Windows **start** button, and from the menu that appears, select **Control Panel**.
- 2 In "Pick a category," click "**Performance and Maintenance**."
- 3 In "or pick a Control Panel icon," click the **System** icon.
- 4 Click the **Advanced** tab.
- 5 At the right of the Performance field, click [**Settings**]. The Performance Options dialog box will appear.
- 6 Click the **Advanced** tab.
- 7 In the **Processor Scheduling** field, select "**Background services**," and click [**OK**].
- 8 In the System Properties dialog box, click [**OK**].
The **System Properties** dialog box will close.

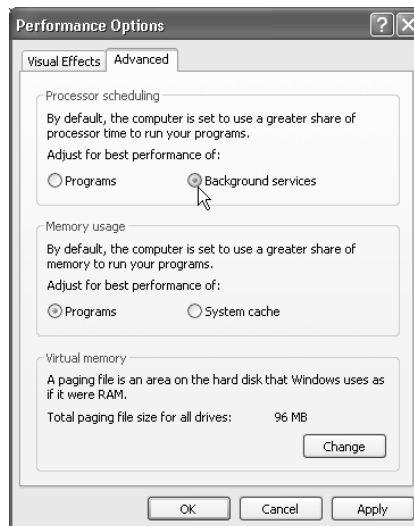

Proceed to the following page.
(-> **Checking for sound output** (p. 41))

Checking for sound output

Now let's play back the sample data to verify that connections, driver installation, and settings were made correctly.

■ Playing back the sample data

Here we will use standard Windows functionality to play the sample data. The sample data is found on the CD-ROM.

1

Prepare the CD-ROM.

Insert the CD-ROM into the CD-ROM drive of your computer.

2

From the **DemoSong** folder of the CD-ROM, drag **Jazz(.MID)** to your desktop, copying it.

3

Right-click the copied file **Jazz(.MID)**, and select **Properties (Play)** for Windows XP/2000/Me).



4

Play back the sample data.

Click the **Preview** tab, and then click the  button.

The music starts playing.

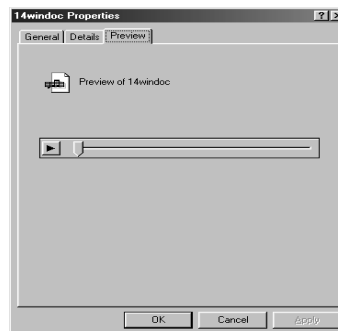

MEMO

Use of the song data supplied with this product for any purpose other than private, personal enjoyment without the permission of the copyright holder is prohibited by law. Additionally, this data must not be copied, nor used in a secondary copyrighted work without the permission of the copyright holder.

MEMO

What you actually see on your computer screen may be different, depending on your computing environment and the operating system you're using.

MEMO

If it did not play back correctly, refer to **Troubleshooting** (p. 57) to determine the reason. This section contains information on how to solve problems such as no sound, or failure to play back correctly.

Was the sample data played back?

If it was played back correctly, this means that the computer and the SD-20 are connected correctly, and that the drivers have been installed correctly.

Getting connected and installing drivers (Macintosh)

What is a driver?

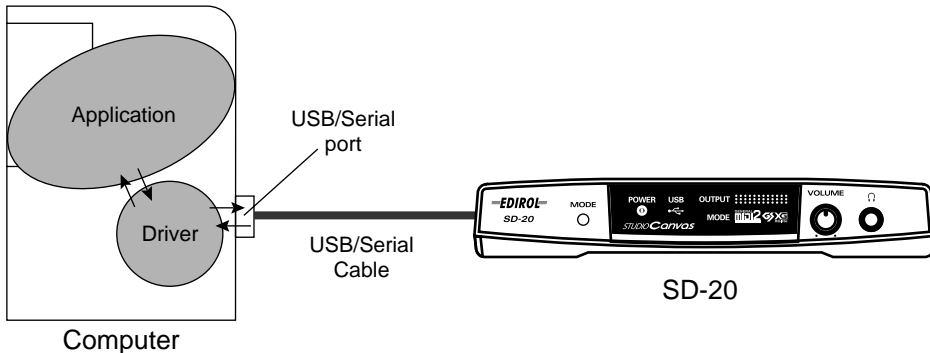

A “driver” is software that transfers data between the SD-20 and application software running on your computer, when your computer and the SD-20 are connected by a USB cable. The driver sends data from your application to the SD-20, and from the SD-20 to your application.

The SD-20 is able to operate using the “**bus power**” that is supplied via the USB cable. This means that the supplied AC adaptor is not necessary. However, if you are using a USB hub, or if not enough power can be supplied via USB, the SD-20 may not operate correctly. In this case, connect the supplied AC adaptor power supply to the SD-20. Even when using the SD-20 with bus power, please connect the AC adaptor when you install the driver.

Which type of connection?

You can either use the USB cable, or use the computer cable to make a serial connection. Depending on the type of connection you are using, install the appropriate driver and make the appropriate settings.

USB connection(p. 43)

Serial connection(p. 50)

USB connection

The following items are required for connections and installation. Please have the following items ready.

- SD-20
- AC adaptor
- USB cable
- CD-ROM

- 1** Turn off the power of the Macintosh and all peripheral devices connected to the Macintosh.
- 2** Set the **computer switch** of the SD-20 to **USB**.
- 3** With the **SD-20's power switch turned off**, connect it to the **AC adaptor**.
- 4** Plug the **AC adaptor** into an AC power outlet.
- 5** Turn on the peripheral devices connected to the Macintosh, except for the SD-20. Then turn on the power of the Macintosh itself.

* *Do not turn on the power of the SD-20 at this time.*

If the power of the SD-20 is turned on, a message like the following will appear when the Macintosh is started up. Perform the steps described below as appropriate for the message that is displayed.

If the screen indicates:

**"Driver required for USB device `unknown device' is not available.
Search for driver on the Internet?"**

-> click **[Cancel]**.

If the screen indicates:

**"Software required for using device `unknown device' cannot be found.
Please refer to the manual included with the device, and install the
necessary software."**

-> click **[OK]**.

Use either OMS or FreeMIDI as the MIDI driver.

- If you are using OMS (p. 44)
- If you are using FreeMIDI (p. 48)

* *Either **OMS** or **FreeMIDI** must be installed in your Macintosh, as appropriate for the sequencer software you are using.*

■ Installing the SD-20 driver (OMS)

Use the following procedure to install the SD-20 driver.

The included **SD-20 OMS driver** is an add-on module for using the SD-20 with OMS. In order for you to use it, **OMS must already be installed on the hard disk from which you started up.**

If you would like to learn more about OMS, refer to **OMS_2.3_Mac.pdf** (online manual) in the **OMS2.3.8** folder within the OMS folder of the CD-ROM.

* *Disconnect the SD-20 from the Macintosh before you perform the installation.*

- 1** Exit all currently running software (applications).
If you are using a virus checker or similar software, be sure to exit this as well.
- 2** Prepare the CD-ROM.
Insert the CD-ROM into the CD-ROM drive.
- 3** Double-click the **SD-20 OMS USB Driver-E** icon (found in the **Driver - OMS Driver** of the CD-ROM) to start up the installer.
- 4** Verify the installation location, and click **[Install]**.
- 5** If a message like the following is displayed, click **[Continue]**.
The other currently running applications will exit, and installation will continue.
- 6** A dialog box will indicate Installation completed.
Click **[Restart]** to restart your Macintosh.
- 7** Use the **USB cable** to connect the **SD-20** to your **computer**.
- 8** Set the SD-20's power switch to the ON position.



MEMO

OMS can be found in the OMS2.3.8 folder within the OMS folder of the CD-ROM.

MEMO

You will need the Adobe Acrobat Reader in order to view OMS_2.3_Mac.pdf. The latest version of Adobe Acrobat Reader can be downloaded from the Adobe website. <http://www.adobe.com> (This URL may change without notice.)

MEMO

This unit is equipped with a protection circuit. A brief interval (a few seconds) after power up is required before the unit will operate normally.

OMS settings

1 From the CD-ROM, drag the **Driver-OMS Driver-OMS Settings** folder to the hard disk of your Macintosh to copy it.

2 In the **Opcode-OMS Application** folder where you installed OMS, double-click **OMS Setup** to start it up.



3 If a dialog box like the one shown here appears, click **[Turn It Off]**. A confirmation dialog box will then appear, so click **[OK]**.



4 The Create New Setup dialog box will appear.

Click **[Cancel]**. If you accidentally clicked **[OK]**, click **[Cancel]** in the next screen.



5 Choose "Open" from the File menu.

From the **OMS Settings** folder that you copied in **step 1**, select the **SD-20 USB** file, and click **[Open]**.

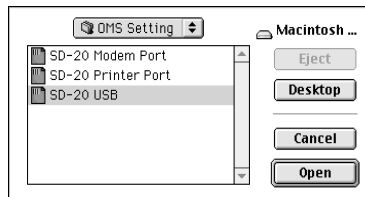

A screen like the one shown here will appear.

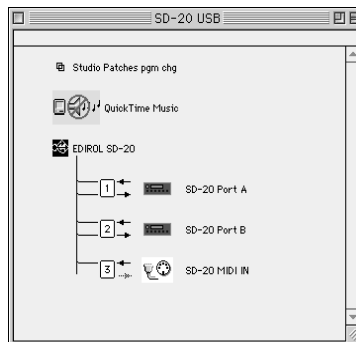

6

From the **Edit** menu, select **OMS MIDI Setup**.

In the **OMS MIDI Setup** dialog box that appears, check **Run MIDI in background**, and click **[OK]**.

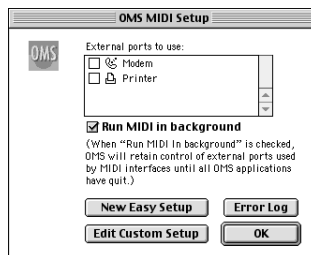

7

From the **File** menu, choose **Make Current**.

If you are unable to select **Make Current**, it has already been applied, and you may continue to the next step.

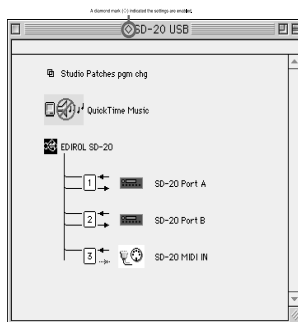

8

Verify that MIDI transmission and reception can be performed correctly. From the **Studio** menu, choose **Test Studio**.



9

When you move the mouse cursor near the sound generator icon, the cursor will change to a musical note shape.

Click on the sound generator icons that are encircled in the following illustration. If sound is heard from the SD-20, the settings are correct. If MIDI is not being transmitted, the Macintosh will produce an alert sound.

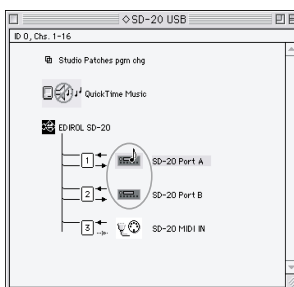

Does the OUTPUT level indicator of the SD-20 move?

If the OUTPUT level meter in the SD-20's display is moving but you do not hear sound, check whether the volume of the SD-20 or your speaker system has been lowered. If the OUTPUT level meter does not move, check the connections and OMS settings once again.

After you have made settings correctly, choose **Test** once again from the **Studio** menu, and perform **step 9**.



If the SD-20 does not produce sound, refer to **No sound** (p. 62).

10

Exit OMS Setup.

From the **File** menu, choose **[Exit]**. If the **AppleTalk confirmation** dialog box appears, click **[OK]** to close the dialog box.

This completes connections for the SD-20 and Macintosh, and installation of the MIDI driver. Now, MIDI data can be input and output (recorded and played).

■ Installing the SD-20 driver (FreeMIDI)

Use the following procedure to install the SD-20 driver. The included **SD-20 FreeMIDI driver** is an add-on module for using the SD-20 with FreeMIDI. In order to use it, **FreeMIDI must be installed on the hard disk from which you started up.**

* *Disconnect the SD-20 from the Macintosh before beginning the installation.*

- 1 Exit all currently running software (applications).
If you are using a virus checker or similar software, be sure to exit this as well.
- 2 Prepare the CD-ROM.
Insert the CD-ROM into the CD-ROM drive.
- 3 Double-click the **SD-20 FM USB Driver-E** icon (found in the **Driver - FreeMIDI - USB Connection** folder of the CD-ROM) to start up the installer.
- 4 Verify the installation location, and click **[Install]**.
- 5 If a message like the following is displayed, click **[Continue]**.
The other currently running applications will exit, and installation will continue.
- 6 A dialog box will indicate Installation completed. Click **[Restart]** to restart your Macintosh.
- 7 Use the **USB cable** to connect the **SD-20** to your **computer**.
- 8 Switch ON the SD-20's Power switch.

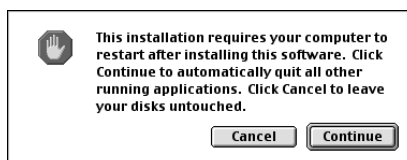

MEMO

This unit is equipped with a protection circuit. A brief interval (a few seconds) after power up is required before the unit will operate normally.

FreeMIDI settings

- 1 From the CD-ROM, copy the **Driver - FreeMIDI Driver - Settings** folder onto the hard disk of your Macintosh.
- 2 Open the FreeMIDI Applications folder from the location into which you installed FreeMIDI, and double-click the **FreeMIDI Setup 1.45** icon to start it up.
- 3 When "OMS is installed on this computer..." appears, click **[FreeMIDI]**.

- 4 The first time the software is started up, a dialog box saying “**Welcome to FreeMIDI!**” will appear. Click [**Continue**].
- 5 When the **FreeMIDI Preferences** dialog box appears, click [**Cancel**].
- 6 When the **About Quick Setup** dialog box appears, click [**Cancel**].
- 7 From the **File** menu, choose **Open**.
- 8 Select **SD-20 USB** from the **FreeMIDI Settings** folder you copied in **step 1**, and click [**Open**].
- 9 Verify that MIDI transmission and reception occur correctly.
From the **MIDI** menu, choose **Check Connections**.

- 10 The mouse cursor will change to the shape of a note. Click the sound generator icons encircled in the diagram at right.

If you hear sound, MIDI messages are being sent from the Macintosh to the SD-20.

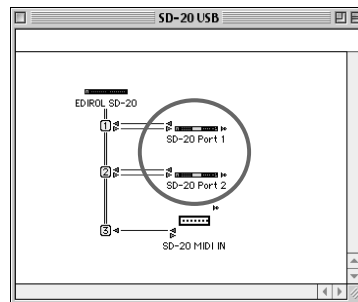

Does the OUTPUT level indicator of the SD-20 move?

If the OUTPUT level meter in the SD-20's display is moving but you do not hear sound, check whether the volume of the SD-20 or your speaker system has been lowered. If the OUTPUT level meter does not move, check the connections and OMS settings once again.

After you have made settings correctly, choose **Test** once again from the **Studio** menu, and perform **step 10**.

- 11 Once again choose the **MIDI** menu command **Check Connections** to end the test.

- 12 From the **File** menu, choose **Quit** to exit **FreeMIDI Setup**.

This completes connections for the SD-20 and Macintosh, and installation of the MIDI driver. Now, MIDI data can be input and output (recorded and played).

MEMO

If the SD-20 does not produce sound, refer to **No sound** (p. 62).

Serial connection

The following items are required for connections and installation. Please have the following items ready.

- SD-20
- AC adaptor
- Computer cable
- CD-ROM

- 1** Turn off the power of the Macintosh and all peripheral devices connected to the Macintosh.
- 2** Set the **computer switch** of the SD-20 to **Mac**.
- 3** Use a computer cable to connect the **modem port** or **printer port** of your Macintosh to the SD-20.
- 4** With the **SD-20's power switch turned off**, connect it to the **AC adaptor**.
- 5** Plug the **AC adaptor** into an AC power outlet.
- 6** Turn on the power of the SD-20 and your Macintosh.

■ Installing the SD-20 driver (OMS)

Use the following procedure to install the SD-20 driver.

The included **SD-20 OMS driver** is an add-on module for using the SD-20 with OMS. In order for you to use it, **OMS must already be installed on the hard disk from which you started up**.

If you would like to learn more about OMS, refer to **OMS_2.3_Mac.pdf** (online manual) in the **OMS2.3.8** folder within the OMS folder of the CD-ROM.

- 1** Exit all currently running software (applications).
If you are using a virus checker or similar software, be sure to exit this as well.
- 2** Prepare the CD-ROM.
Insert the CD-ROM into the CD-ROM drive.
- 3** Double-click the **SD-20 OMS Serial Driver-E** icon (found in the **Driver - OMS Driver** of the CD-ROM) to start up the installer.

MEMO

This unit is equipped with a protection circuit. A brief interval (a few seconds) after power up is required before the unit will operate normally.

MEMO

OMS can be found in the OMS2.3.8 folder within the OMS folder of the CD-ROM.

MEMO

You will need the Adobe Acrobat Reader in order to view OMS_2.3_Mac.pdf. The latest version of Adobe Acrobat Reader can be downloaded from the Adobe website. <http://www.adobe.com> (This URL may change without notice.)

4 Verify the installation location, and click **[Install]**.

5 If a message like the following is displayed, click **[Continue]**.
The other currently running applications will exit, and installation will continue.

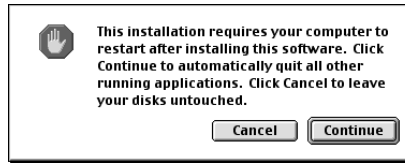

6 A dialog box will indicate Installation completed.
Click **[Restart]** to restart your Macintosh.

OMS settings

1 From the CD-ROM, drag the **Driver-OMS Driver-OMS Settings** folder to the hard disk of your Macintosh to copy it.

2 In the **Opcode-OMS Application** folder where you installed OMS, double-click **OMS Setup** to start it up.



3 If a dialog box like the one shown here appears, click **[Turn It Off]**. A confirmation dialog box will then appear, so click **[OK]**.

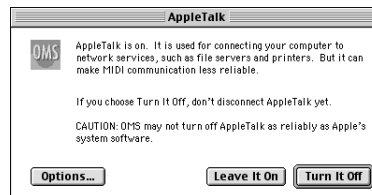

4 The Create New Setup dialog box will appear.
Click **[Cancel]**. If you accidentally clicked **[OK]**, click **[Cancel]** in the next screen.



5

Choose “**Open**” from the File menu.

Open the **OMS Settings** folder copied in **Step 1**, select the file for the name of the port to which the SD-20 is connected, and click [**Open**].

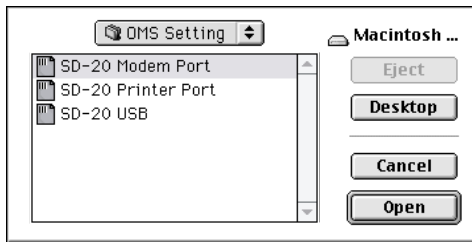

A screen like the one shown here will appear.

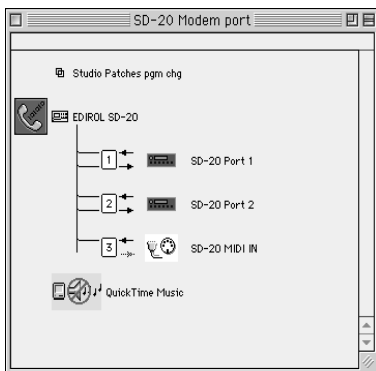

Opening the SD-20 Modem Port file

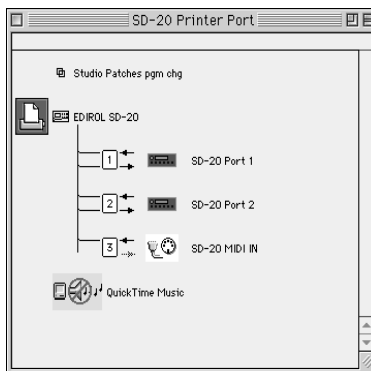

Opening the SD-20 Printer Port file



When connecting to a combined modem/printer port such as on PowerBooks, select the “SD-20 Modem Port” file.

6

From the **Edit** menu, select **OMS MIDI Setup**.

In the **OMS MIDI Setup** dialog box that appears, check **Run MIDI in background**, and click [**OK**].

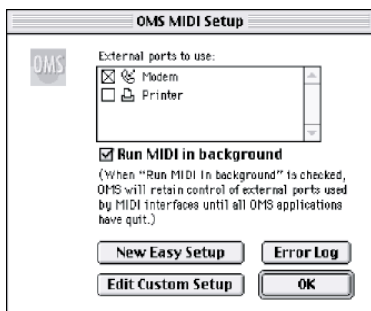

Opening the SD-20 Modem Port file

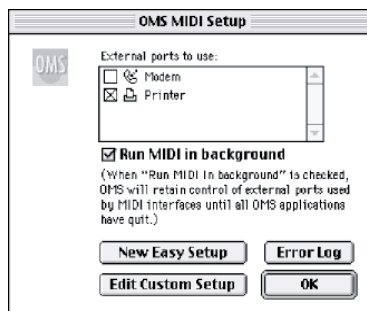

Opening the SD-20 Printer Port file

7

From the **File** menu, choose **Make Current**.

If you are unable to select **Make Current**, it has already been applied, and you may continue to the next step.

A diamond mark (◊) indicates the settings are enabled.

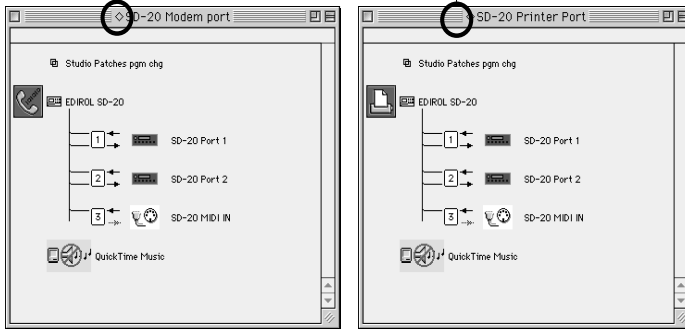

Opening the SD-20 Modem Port file

Opening the SD-20 Printer Port file

8

Verify that MIDI transmission and reception can be performed correctly. From the **Studio** menu, choose **Test Studio**.



9

When you move the mouse cursor near the sound generator icon, the cursor will change to a ♪ shape.

Click on the sound generator icons that are encircled in the following illustration. If sound is heard from the SD-20, the settings are correct. If MIDI is not being transmitted, the Macintosh will produce an alert sound.

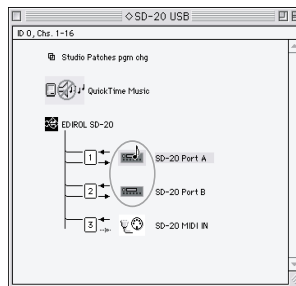

Does the OUTPUT level indicator of the SD-20 move?

If the OUTPUT level meter in the SD-20's display is moving but you do not hear sound, check whether the volume of the SD-20 or your speaker system has been lowered. If the OUTPUT level meter does not move, check the connections and OMS settings once again.

After you have made settings correctly, choose **Test** once again from the **Studio** menu, and perform **step 9**.

10

Exit OMS Setup.

From the **File** menu, choose **[Exit]**. If the **AppleTalk confirmation** dialog box appears, click **[OK]** to close the dialog box.

This completes connections for the SD-20 and Macintosh, and installation of the MIDI driver. Now, MIDI data can be input and output (recorded and played).

MEMO

If the SD-20 does not produce sound, refer to **No sound** (p. 62).

■ Installing the SD-20 driver (FreeMIDI)

Use the following procedure to install the SD-20 driver. The included **SD-20 FreeMIDI driver** is an add-on module for using the SD-20 with FreeMIDI. In order to use it, **FreeMIDI must be installed on the hard disk from which you started up.**

- 1** Exit all currently running software (applications).
If you are using a virus checker or similar software, be sure to exit this as well.
- 2** Prepare the CD-ROM.
Insert the CD-ROM into the CD-ROM drive.
- 3** Double-click the **SD-20 FM Serial Driver-E** icon (found in the **Driver - FreeMIDI Driver** folder of the CD-ROM) to start up the installer.
- 4** Click **[Install]**.
- 5** A dialog box will inform you that you will need to restart your Macintosh when installation is finished. Click **[Continue]**.
- 6** When the installation is complete, click **[Restart]**.

FreeMIDI settings

- 1** From the CD-ROM, copy the **Driver - FreeMIDI Driver - Free MIDI Settings** folder onto the hard disk of your Macintosh.
- 2** Open the FreeMIDI Applications folder from the location into which you installed FreeMIDI, and double-click the **FreeMIDI Setup** icon to start it up.
- 3** When “**OMS is installed on this computer...**” appears, click **[FreeMIDI]**.
- 4** The first time the software is started up, a dialog box saying “**Welcome to FreeMIDI!**” will appear. Click **[Continue]**.
- 5** When the **FreeMIDI Preferences** dialog box appears, click **[Cancel]**.
- 6** When the **About Quick Setup** dialog box appears, click **[Cancel]**.

7

From the **File** menu, choose **Open**.

Open the **FreeMIDI Settings** folder copied in **Step 1**, select the file for the name of the port to which the SD-20 is connected, and click [**Open**].

8

Verify that MIDI transmission and reception occur correctly.

From the **MIDI** menu, choose **Check Connections**.

9

The mouse cursor will change to the shape of a note. Click the sound generator icons encircled in the diagram at right.

If you hear sound, MIDI messages are being sent from the Macintosh to the SD-20.

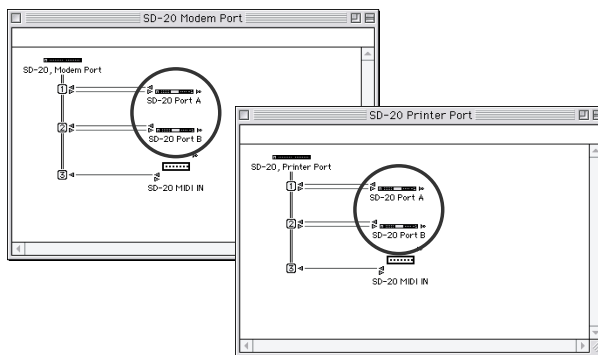

Does the OUTPUT level indicator of the SD-20 move?

If the OUTPUT level meter in the SD-20's display is moving but you do not hear sound, check whether the volume of the SD-20 or your speaker system has been lowered. If the OUTPUT level meter does not move, check the connections and OMS settings once again.

After you have made settings correctly, choose **Test** once again from the **Studio** menu, and perform **step 9**.

MEMO

If the SD-20 does not produce sound, refer to **No sound** (p. 62).

10

Once again choose the **MIDI** menu command **Check Connections** to end the test.

11

From the **File** menu, choose **Quit** to exit **FreeMIDI Setup**.

This completes connections for the SD-20 and Macintosh, and installation of the MIDI driver. Now, MIDI data can be input and output (recorded and played).

Troubleshooting

If an unexpected problem occurs while using the SD-20, read this chapter first. It contains numerous tips for resolving problems.

If you are using Windows or Macintosh for the first time, and as a result find it difficult to follow the procedural explanations, please refer to the manuals that came with your computer or operating system.

Troubleshooting is organized according to different operating systems. Refer to the icon(s) at the left of the title to find the items you need.



Problems common to Windows and Macintosh



Problems occurring only in Windows



Problems occurring only in Macintosh

Problems related to the USB driver



Cannot install the driver correctly

- **Is the CD-ROM correctly inserted into your CD-ROM drive?**
Installation is not possible unless the CD-ROM included with the SD-20 is inserted in your CD-ROM drive. Make sure that the CD-ROM is correctly inserted into your CD-ROM drive.
- **Is the CD-ROM or the lens of the CD-ROM dirty?**
If the CD-ROM or the lens of the CD-ROM drive is dirty, the installer may not work correctly. Clean the disc and/or lens using a commercially-available CD cleaner or lens cleaner.
- **Are you installing the software from a networked CD-ROM drive?**
The software cannot be installed from a networked CD-ROM drive.
- **Is there sufficient free space on your hard disk?**
Delete unneeded files to increase the amount of free space. After deleting the unneeded files, empty the recycling bin.
- **Is the SD-20 connected correctly?**
Make sure that the USB connector of your computer is connected to the SD-20 by a USB cable. Check this, and if you are using Windows, close the **Sound and Multimedia Properties** dialog box (**Multimedia Properties** in Windows 98), re-open the same dialog box once again, and specify the audio and MIDI input/output destinations.
("Settings and checking" (p. 38))
- **Is the power of the SD-20 turned on?**
Make sure that the SD-20's POWER switch has been pressed inward. Check this, and if you are using Windows, close the **Sound and Multimedia Properties** dialog box (**Multimedia Properties** in Windows 98), re-open the same dialog box once again, and specify the MIDI input/output destinations.



- Using the procedure for "**Deleting the driver**" (p. 64), delete the USB audio device driver installed in your computer, and then re-install the SD-20 driver as described in "**Getting connected and installing drivers (Windows)**" (p. 16). Also check whether there is any "**Unknown device**" in "**Other devices**" or "**Universal Serial Bus Controllers.**" If you find any, delete them.



- **Is OMS or FreeMIDI installed?**
The SD-20 driver cannot be installed unless **OMS** or **FreeMIDI** are installed. Please install **OMS** or **FreeMIDI**. (OMS -> p. 44, p. 50 FreeMIDI -> p. 48, p. 55)



SD-20 is not detected when making OMS or FreeMIDI settings

- **Is the SD-20 detected?**
Turn the power of the SD-20 off, then on again.

Reconnect the USB cable.

If other USB devices are connected, connect only the SD-20.

It is possible that the Macintosh did not correctly detect and initialize the SD-20. Leave the SD-20's USB cable connected, and restart your Macintosh. If it is still not detected, shut down your Macintosh, and then restart it.

The SD-20 will not be detected if it is connected to the USB connector on the Macintosh keyboard. Please connect the SD-20 to a USB connector on the Macintosh itself.

- **Are you using only OMS?**
If you are using OMS, the system will not operate correctly if FreeMIDI is installed. Delete FreeMIDI-related files from the Extensions folder.

An “Unknown driver found” dialog box appears, and you are unable to install the driver

”Find new hardware wizard” does not execute automatically

”Find new hardware wizard” ends before the process is completed

- It may take about 15 seconds (or more) after the USB cable is connected for the SD-20 to be detected.
- Is the USB cable connected correctly?
Make sure that the SD-20 and your computer are correctly connected via a USB cable.
- Is USB enabled on your computer?
Refer to the operation manual for your computer, and make sure that USB is enabled.
- Does your computer meet the USB specifications?
If you are using a computer that does not fulfill the electrical requirements of the USB specifications, operation may be unstable. In this case, you may be able to solve the problem by connecting a USB hub.
- Does “Unknown device” appear for “Other device” or “Universal serial bus controller”?
Use the following procedure to delete “Other device” (Universal Serial Bus Controller) “Unknown device,” and then restart your computer.
 1. In the Windows **Control Panel**, double-click System. The **System Properties** dialog box will appear.
 2. Click the **Device Manager** tab. For Windows XP/2000, click the **Hardware** tab, and then click the [**Device Manager**] button.
 3. Double-click “Other device” or “Universal Serial Bus Controller” to display a list of devices.
 4. From the list, select the unknown device and click [**Delete**].
 5. In the dialog box that asks you to confirm the deletion, click [**OK**].
 6. Verify that “Other device” or “Unknown device” is not displayed in the list, and click [**Close**] to close the dialog box.

”Found unknown device” appears even though you installed the driver

If your computer or USB hub has two or more USB connectors, and you connect the SD-20 to a USB connector to which the SD-20 has never been connected before, the “Unknown device” dialog box may appear even on a computer onto which you have already installed the driver.

Refer to “Getting connected and installing drivers (Windows)” (p. 16), and install the driver once again. This is not a malfunction.



Can't install/delete/use the driver in Windows XP/2000

- **Did you log on to Windows as a user with administrative privileges?**
In order to install/delete/re-install the driver in Windows XP/2000, you must be logged into Windows as a user with administrative privileges, such as Administrator. For details, please contact the system administrator for your computer system.
- **Did you make "Driver signature settings"?**
In order to install/re-install the driver, you must make "Driver Signing."
(Windows XP -> p. 17, Windows 2000 -> p. 22)



Windows XP/2000 displays a "Digital signature was not found" dialog box

- **Did you make "Driver signature settings"?**
In order to install/re-install the driver, you must make the settings described in "Driver Signing."
(Windows XP -> p. 17, Windows 2000 -> p. 22)



Device Manager shows "?", "!", or "USB Composite Device"



The "Insert Disk" dialog box does not appear

Use the following procedure to re-install the driver.

1. Turn off the power of your computer, and start up Windows with all USB cables disconnected (except for keyboard and mouse).
2. After Windows restarts, use a USB cable to connect the SD-20 to your computer.
3. Turn on the power of SD-20.
4. Click the Windows **[Start]** button, and from the menu that appears, choose **Settings | Control Panel**.
5. Double-click the **System** icon. The **System Properties** dialog box will appear.
6. Click the **Device Manager** tab.
7. Check whether you can see an indication of "**?Composite USB Device, ?USB Device, !USB Device,**" or "**USB composite device**" displayed below "**Sound, Video, and Game Controllers, Other Devices,**" or "**Universal Serial Bus Controller.**" If you find any such indication, select it and click **[Delete]**.
8. A dialog box will ask you to confirm deletion of the device. Verify the contents of the dialog box, and then click **[OK]**. In the same way, delete all indications of "**?Composite USB Device,**" "**?USB Device,**" "**USB Device,**" and "**USB composite device**" that you find.
9. If you find **EDIROL SD-20** USB Driver with a yellow "**!**" or a red "**?**" displayed beside it, delete this in the same way.
10. When you have finished deleting the unwanted devices, click **[OK]** in the **System Properties** dialog box.
11. Turn off the power of the SD-20, then delete the driver. "**Deleting the driver**" (p. 64)

12. Restart Windows. Then install the driver once again. "**Getting connected and installing drivers (Windows)**" (p. 16).

** If the problem still occurs after you have taken the above measures, please refer also to the Readme file for the USB driver. The Readme file is on the CD-ROM.*

[Location]

Windows 2000 users:

In the CD-ROM,

Driver\Win2000\WDM\README_E (if using the WDM driver)

Driver\Win2000\MME\README_E (if using the MME driver)

Windows Me/98 users:

In the CD-ROM,

Driver\Win98ME\WDM\README_E

Problems when using the SD-20



Operating system becomes unstable

- **Operation becomes unstable when the computer is started up with the SD-20 already connected**

Please start up your computer with the SD-20 disconnected, and then connect the SD-20. On a computer that uses a USB keyboard, starting up the computer with the SD-20 already connected may cause operation to become unstable. In this case, start up the computer with the SD-20 disconnected, and then connect the SD-20.



The volume level of the instrument connected to INPUT Jack is too low.

- **Could you be using a connection cable that contains a resistor?**
Use a connection cable that does not contain a resistor.



No sound

- **Have you specified the MIDI data output destination in your operating system?**
On your computer, you will need to specify the SD-20 as the output destination for MIDI data. For details on how to make this setting, refer to Settings and checking.
(Windows -> (p. 28) , Macintosh -> (p. 45, p. 48, p. 51, p. 55)
- **Have you specified the audio data output destination for your playback software?**
Depending on your software, you may need to once again specify the SD-20 as the MIDI data output destination. For details on this setting, refer to the operation manual for your application.
- **Are you running multiple applications?**
If multiple applications are running simultaneously, an error message may be displayed. If this occurs, click [OK] and exit the other applications.
Even if an application window is closed, it is still running if it appears in the taskbar. Be sure to exit unneeded applications displayed in the taskbar.
- **Was the driver installed correctly?**
In order for you to play back MIDI data via the SD-20, the driver must be installed. For installation and settings, refer to "Getting Connected and Installing Drivers" (Windows, p. 16/ Macintosh, p. 42).
- **Is your audio playback equipment (e.g., stereo system) connected correctly?**
Make sure that the USB connector of your computer is connected to the SD-20 by a USB cable. Make sure that the SD-20's **OUTPUT** jacks are connected by audio cables to the input jacks of your audio playback equipment. For details on connections, refer to "Basic connections" (p. 12).
- **Is the power of your audio equipment turned on?**
Make sure that the power is turned on for your audio equipment (e.g., stereo) and the SD-20.
- **Are the various volume settings of the SD-20 set appropriately?**
Use the **Volume knob** located on the front panel of the SD-20 to adjust the volume.
- **Is your computer in Suspend or Sleep mode?**
If so, get your computer to resume normal operation, then exit all applications that are using the SD-20. Next, turn the SD-20's power off, then switch it on again.
- **Did you reconnect the USB cable or turn the power of the SD-20 off and on?**
Exit all applications that are using the SD-20, and turn the power of the SD-20 off and then on once again.



- **Is OMS/FreeMIDI set correctly?**
As described in "OMS settings" (p. 45), (p. 51) or "FreeMIDI settings" (p. 48), (p. 55) check the OMS or FreeMIDI settings. Also make sure that the device for MIDI IN/OUT is correctly selected in the MIDI settings of your MIDI sequencer software.



- **Does the OUTPUT level indicator of the SD-20 move?**
If the INST level meter is moving but you do not hear sound, check whether the volume of the SD-20 or your speakers has been lowered. If the INST level meter of the SD-20 is not moving, recheck the connections and "OMS settings" (p. 45), (p. 51) / "FreeMIDI settings" (p. 48), (p. 55).



- **Check the Apple Talk settings (if the SD-20 is connected via a serial connection).**
If you are using a Macintosh on which Open Transport is installed, and which does not have an Ethernet port, input/output via OMS will not be possible (if the internal Local Talk port is being used). If you are using this type of system, reconnect the SD-20 to the modem port, or turn Apple Talk off and restart your Macintosh.



- **Is the OMS setup enabled?**
If a diamond-shaped symbol is not displayed at the left edge of the title area in the OMS setup window, the setup is not enabled. From the OMS File menu, choose "Make Current."
("OMS settings" (p. 45), (p. 51))



- **Has your computer been set to enter Sleep mode?**
If your computer enters Sleep mode, exit the software you are using, and then restart your computer. We recommend that you set your computer to not use Sleep mode.

Can't play back MIDI



- **Has the MIDI device you are using been set correctly?**
In order to record/play MIDI tracks using the SD-20, you must correctly install the SD-20 driver ("Getting connected and installing drivers (Windows)" (p. 16)). Also make sure that the input port and output port are set as follows in your software.

INPUT port	OUTPUT port
EDIROL SD-20 MIDI IN 1	EDIROL SD-20 PART A
EDIROL SD-20 MIDI IN 2	EDIROL SD-20 PART B



- **Has the MIDI device you are using been selected correctly?**
Select either [SD-20 Port A] or [SD-20 Port B] as the MIDI output device. MIDI will not be output if you select [EDIROL SD-20].



- **Is the serial port selected correctly?**

It is possible that the serial port (COM port) you selected in the Roland Serial MIDI Driver Settings dialog box is being used by another device, or has not been detected by the system.

Connect the SD-20 to a different serial port, and change the settings appropriately. -> "**Settings and checking**" (p. 38)



- **Are the track outputs set correctly?**

MIDI tracks to which no MIDI playback device is assigned will not be heard. If you want to play back a MIDI track, you must make sure that the MIDI device you want to use is displayed in your software as the MIDI output port. For details, refer to the owner's manual for your software.

Deleting the driver

If you were unable to install the driver according to the procedure given, the SD-20 may not be recognized correctly by the computer. In this case, use the following procedure to delete the driver, and then follow the procedure in "**Getting Connected and Installing Drivers**" (Windows, p. 16; Macintosh, p. 42) to install the driver once again.

Windows XP/2000 users

In order to delete (uninstall) the driver, a user with **administrative privileges** such as **Administrator** must be logged onto Windows. For details, contact the system administrator of your computer.

1. With all USB cables disconnected, start Windows. (USB keyboard and USB mouse excepted)
2. Log on to Windows as a user with **administrative privileges** (such as **Administrator**).
3. After connecting the SD-20 to your computer via a USB cable, turn on the power of the SD-20.
4. Exit all applications before deleting the driver.
5. Open the **Control Panel**, and double-click **System**.
6. Click the **Hardware** tab, and in the "**Device Manager**" area, click [**Device Manager**].
7. Double-click "**Sound, Video, and Game Controllers**" to view the **list of devices**.
8. From the list, click "EDIROL SD-20" to select it. Then right-click, and from the menu that appears, select "Delete."
 - * If "**EDIROL SD-20**" does not appear in the list, refer to the "**Can't install/delete/use the driver in Windows XP/2000**" (p. 60) in "**Troubleshooting**."
9. A dialog box will ask you to confirm that you want to delete the device. Verify the contents of the dialog box, and click [**OK**].
10. Close the **Device Manager** window, and click [**OK**] in **System Properties**.
11. Disconnect the USB cable from the SD-20.
12. Restart Windows.

Windows Me/98 users

1. With all USB cables disconnected, start up Windows. (USB keyboard and USB mouse excepted)
2. After connecting the SD-20 to your computer via a USB cable, turn on the power of the SD-20.
3. Exit all applications before deleting the driver.
4. Open the **Control Panel**, and double-click **System**.
* *Depending on the state of your computer, **System** may not appear in the **Control Panel**. In this case, click "**Show all control panel options**."*
5. Click the **Device Manager** tab.
6. Double-click "**Sound, video, and game controllers**" to see a list of devices.
7. From the list, click "**EDIROL SD-20**" to select it, and click [**Delete**].
8. A dialog box will appear, asking you to confirm that you want to **delete the driver**. Verify the contents, and click [**OK**].
9. Click [**Close**] to close System Properties.
10. Disconnect the USB cable from the SD-20.
11. In **Control Panel**, click **Folder Options** and then click the **Display** tab. (In Windows 98, click **Start | Settings | Folder Options**)
12. In **Detailed Settings** of the **Display** tab, remove the check mark for "**Don't display extensions of associated files**," click "**Show all files and folders**," and then click [**OK**]. (In Windows 98, this will be "**Show all files**.")
13. Click **Start | Find | Files or folders**.
14. In "Search location," select "Local hard drive." Then in "Name of file or folder," type "*0022.*" and click [**Begin search**].
15. Of the files that are found, delete the five files **Rdas0022.DLL**, **Rddp0022.dat**, **Rddv0022.driv**, **Rdvv0022.vxd**, and **Rdwm0022.sys**. If the list shows **Rdif0022.inf** or **RolandRDIF0022.INF**, delete these files as well.
* *Never delete any file other than the files specified here.*
16. Restart Windows.

Macintosh users

1. Switch off the SD-20's power.
If you're running the SD-20 on BUS power, disconnect the USB cable that connects the SD-20 to the Macintosh.
2. From the system extensions folder, drag "**USB SD-20 Driver**" into the trash to delete it.
3. Delete the **SD-20** from the **OMS Folder** inside the **System folder**, or delete **SD-20 Driver** from the **FreeMIDI Folder**.

Serial MIDI driver settings

The serial MIDI driver must be set appropriately for your computer and for the MIDI sound module that is connected. If the sound module does not produce sound, use the following procedure to make settings for the Roland serial MIDI driver.

Windows XP and 2000 users

1. In the **Control Panel**, double-click **Sound and Audio Devices**.
(**Sound and Multimedia** in the case of Windows 2000.)
2. Click the **Hardware** tab.
3. From the list of devices, choose **Roland Serial MIDI Driver**, and click [**Properties**].
4. In the **Roland Serial MIDI Driver Properties** dialog box, click the **Properties** tab.
5. In the list of **multimedia devices**, double-click **MIDI Devices and Instruments**. Under that, select **Roland Serial MIDI Driver**, and click [**Properties**].
6. In the **Roland Serial MIDI Driver Properties** dialog box, click [**Settings**].
7. The **Roland Serial MIDI Driver Settings** dialog box will appear.

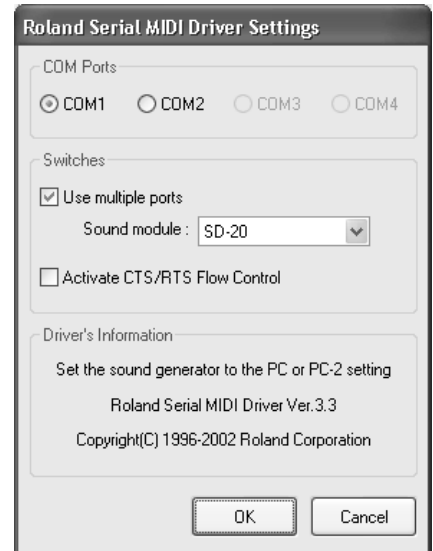

Make settings for each item as described on the next page and following.

Windows Me and Windows 98 users

1. In the **Control Panel**, double-click the **Sound and Multimedia** icon.
(**Multimedia** in the case of Windows 98.)
2. Click the **Device** tab.
3. Double-click [**MIDI Devices and Instruments**]. Under that, click [**Roland Serial MIDI Out A**].
4. In the lower right of the dialog box, click [**Properties**].
5. In the **Roland Serial MIDI Out A Properties** dialog box, click [**Settings**].
6. The **Roland Serial MIDI Driver Settings** dialog box will appear.

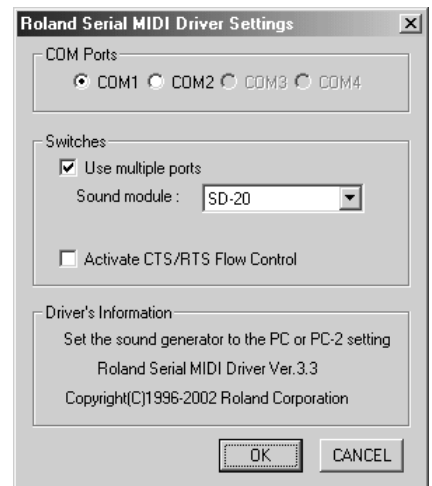

Make settings for each item as described on the next page and following.

■ Which serial port should I use?

Most computers let you use up to four serial ports (COM1--COM4).

In the "COM Ports" field, select the serial port (COM port) that you will use to connect your sound module.

Be aware of two points.

- You must use a serial port that is not being used by another device.
- You must use the serial port that corresponds to the serial connector to which your sound module is connected.

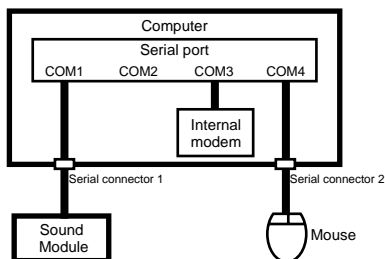

In the diagram at left, COM3 and Com4 are already used by other devices, and cannot be used for the serial MIDI driver. COM1 and COM2 are not used by any other device, but in this case, the serial connector corresponds to COM1, so you should select **COM1** in the "COM Ports" field.

To determine which serial port corresponds to the serial connector to which your sound module is connected, refer to the owner's manual for your computer or contact the manufacturer of your computer. Depending on the internal connections of your computer, the serial connector may not be connected to any of the serial ports (COM1--COM4). In this case, refer to the owner's manual for your computer, and change the settings.

■ How many MIDI OUT ports can I use?

If [Use multiple ports] is checked, you will be able to use the multiple ports of the SD-20 from your computer via the Roland serial MIDI driver.

When you use multiple ports, you will be able to use two MIDI OUT devices and two MIDI IN devices from your computer.

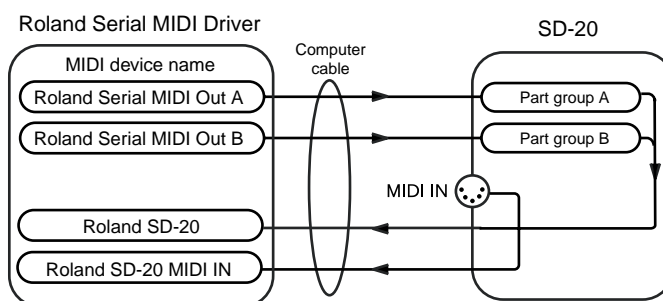

Select [SD-20] in the "Sound module" field. With this setting, you will be able to use two MIDI OUT ports and two MIDI IN ports from your computer.

■ Using flow control

The SD-20 supports CTS/RTS Flow Control, a control function that temporarily pauses data transmission/reception. By checking [Activate CTS/RTS Flow Control], you may be able to avoid problems with transmitting performance data.

■ Setting the computer switch of the sound module

Set the computer switch of the SD-20 sound module to [PC], as directed by the comment in the "Driver's Information" area. If you change the setting of the computer switch, you need to switch off the sound module, then turn it on again. The change in the computer switch setting won't take effect until the next time the unit is powered up.

■ Specifying the MIDI data output destination

The MIDI data output destination (MIDI output device) setting may be inadvertently changed when you install another MIDI driver.

If the sound module connected to your computer fails to sound, or if you decide to use a different output device, you can change this setting as necessary. (->"**Settings and checking**" (p. 38))

Uninstalling the serial MIDI driver

Windows XP and 2000 users

1. Log on to Windows as a user with **administrative privileges** (e.g., Administrator).
2. Open the **System Properties** dialog box.
Right-click the **My Computer** icon, and in the menu that appears, select **Properties**. In Windows XP, **My Computer** is located in the **Start** menu.
3. Click the **Hardware** tab.
4. In the **Device Manager** area, click **[Device Manager]**.

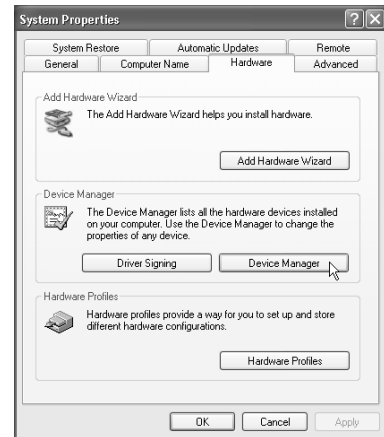

5. Double-click "**Sound, video and game controllers**." A list of device will appear.
6. Right click "**Roland Serial MIDI Driver**," and choose **Uninstall** from the menu that appears.

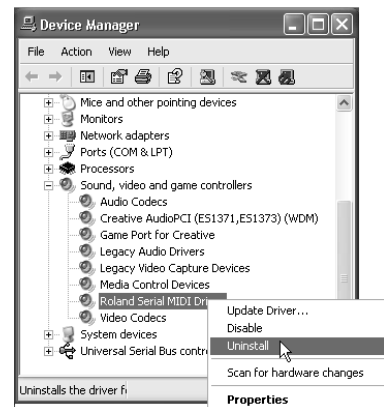

7. A dialog box will ask you to confirm device removal. Click **[OK]**.
8. Close the Device Manager, and click **[OK]** in the System Properties dialog box.
9. Restart Windows.



When Windows restarts, the serial MIDI driver will be deleted.

Windows Me and Windows 98 users

1. From the Windows **Start** menu, select **Settings**, and then select the **Control Panel**.
2. Double-click the **Sound and Multimedia** icon. The **Sound and Multimedia Properties** dialog box will appear. (**Multimedia**, in the case of Windows 98.)
3. Access the **[Devices]** screen.
4. In the list, double-click **[MIDI Devices and Instruments]**.
5. Click **[Roland Serial MIDI Out A]**, and then click **[Properties]** in the lower right of the dialog box. The **Roland Serial MIDI Out A Properties** dialog box will appear.

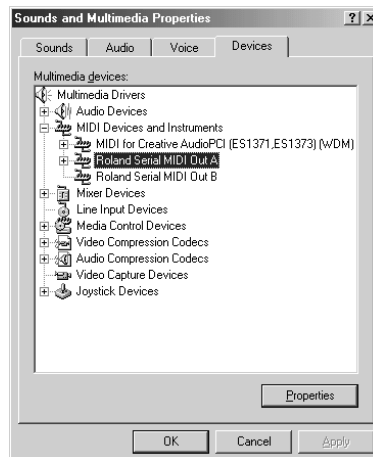

6. In the lower right of the dialog box, click **[Remove]**. Several dialog boxes will appear, asking you to confirm the operation.



When Windows restarts, the serial MIDI driver will be deleted.

Macintosh users

1. Switch off the SD-20's power.
If you're running the SD-20 on BUS power, disconnect the USB cable that connects the SD-20 to the Macintosh.
2. Delete the **SD-20 Serial Driver** from the **OMS Folder** inside the **System folder**, or delete **SD-20 Serial** from the **FreeMIDI Folder**.

Appendices

Instrument list (GM2 / Native mode)

* To select sound sets, you can use either NRPN or exclusive messages.

Piano

PC	LSB	Classic Set MSB: 96	Voices	Contemp Set MSB : 97	Voices	Solo Set MSB : 98	Voices
1	0	Piano 1	1	Ac.Piano	1	St.Piano 1	2
	1	Piano 1w	1	Ac.Piano w	1	St.Piano 1w	2
	2	Piano 1d	1	Mild Piano	1	European Pf	4
2	0	Piano 2	1	Rock Piano	1	St.Piano 2	2
	1	Piano 2w	1	Rock Piano w	1	St.Piano 2w	2
3	0	Piano 3	1	E.Grand Pf	2	SA Piano	2
	1	Piano 3w	1	E.Grand Pf w	2	SA Piano w	2
4	0	Honky-tonk	2	Old Honky	2	St.Honky	4
	1	Honky-tonk w	2	Old Honky w	2	St.Honky w	4
5	0	E.Piano 1	3	Soft Rhodes	2	Tremo Rhodes	2
	1	Detuned EP1	2	Fat Rhodes	3	Sweet Tynes	3
	2	Dyno Rhodes	1	Rhodes Wide	2	Tremo Dyno	4
	3	60's E.Piano	2	Wurly Soft	2	Tremo Wurly	2
6	0	E.Piano 2	2	FM E.Piano	2	FM Hard EP	1
	1	Detuned EP2	3	Soft FM EP	3	Brite FM EP	2
	2	E.Piano 2v	2	SA E.Piano	2	Brite FM EP2	2
	3	EP Legend	2	EP Legend 2	3	EP Legend 3	4
7	0	EP Phase	2	EP Phase 2	2	EP Phase 3	3
	0	Harpsichord	1	Harpsi 2	2	St.Harpsichd	2
	1	Coupl hps	2	Coupl hps 2	4	St.Coupl hps	4
	2	Harpsi w	1	Harpsi 2 w	2	St.Harpsi w	2
8	0	Harpsi o	1	Harpsi 2 o	2	St.Harpsi o	2
	1	Clav	1	Atack Clav 1	2	Atack Clav 2	2
8	1	Pulse Clav	1	AnalogClav 1	1	AnalogClav 2	2

Chromatic percussion

PC	LSB	Classic Set MSB: 96	Voices	Contemp Set MSB : 97	Voices	Solo Set MSB : 98	Voices
9	0	Celesta	1	Celesta 2	2	St.Celesta	3
10	0	Glockenspiel	1	Glocken 2	2	St.Glocken	3
11	0	Music Box	1	Music Box 2	2	St.Music Box	3
12	0	Vibraphone	1	Vibraphone 2	2	St.Vibra	2
	1	Vibraphone w	1	Vibraphone2w	2	St.Vibra w	2
13	0	Marimba	1	Marimba 2	2	St.Marimba	3
	1	Marimba w	1	Marimba 2 w	2	St.Marimba w	3
14	0	Xylophone	1	Xylophone 2	2	St.Xylophone	4
15	0	Tubular-bell	1	Tubular-bel2	2	St.Tubular	3
	1	Church Bell	1	Church Bell2	2	St.Church	4
	2	Carillon	1	Carillon 2	2	St.Carillon	4
16	0	Santur	1	Santur 2	2	St.Santur	3

Organ

PC	LSB	Classic Set MSB: 96	Voices	Contemp Set MSB : 97	Voices	Solo Set MSB : 98	Voices
17	0	Organ 1	2	Perky	2	Roller	3
	1	Detuned Or1	2	Ballad B	3	Rocker	4
	2	Organ 60	1	Happy 60s	1	Soft60'Organ	1
	3	Organ 4	2	Tone Wheel	2	Full Stops	2
18	0	Organ 2	2	Jazz Organ 1	3	Jazz Organ 2	2
	1	Detuned Or2	2	Perc.Organ 1	3	Perc.Organ 2	3
	2	Organ 5	3	Dist.JzOrg 1	2	Dist.JzOrg 2	2
19	0	Organ 3	1	Organ 3 fast	1	Rock Organ	3
20	0	Church 1	1	Pipe Organ 1	2	Pipe Organ 2	3
	1	Church 2	2	LargeChurch1	4	LargeChurch2	3
	2	Church 3	1	SmallChurch1	2	SmallChurch2	4
21	0	Reed Organ	1	Reed Organ 2	2	Reed Organ 3	3
	1	Puff Organ	2	Organ Flute	1	Theater	4

22	0	Accordion F	1	French Acc	2	St.FrenchAcc	3
	1	Accordion I	1	It Muset	2	St.It Muset	3
23	0	Harmonica	1	Harmonica 2	1	St.Harmonica	3
24	0	Bandneon	2	Bandneon 1	2	St.Bandneon	4

Guitar

PC	LSB	Classic Set MSB : 96	Voices	Contemp Set MSB : 97	Voices	Solo Set MSB : 98	Voices
25	0	Nylon Gt	1	Nylon Gt 2	1	Nylon Gt 3	1
	1	Ukulele	1	Ukulele 2	1	Ukulele 3	1
	2	Nylon o	2	Nylon 2 o	2	Nylon 3 o	2
	3	Nylon Gt.2	1	Hard Gut Gt	1	Hard Gut Gt2	2
26	0	Steel-str.Gt	1	OV Steel Gt	1	SteelStr.Gt2	1
	1	12-Str.Gt	2	12-Str.Gt 2	2	12-Str.Gt 3	3
	2	Mandolin	2	Mandolin 2	2	Mandolin 3	2
	3	Steel+Body	2	Steel+Body 2	2	Steel+Body 3	2
27	0	Jazz Gt	1	Jazz Gt 2	1	Jazz Gt 3	1
	1	Pedal Steel	1	Pedal Steel2	2	Pedal Steel3	2
28	0	Clean Rear	1	TC Rear	1	Strat2 Rear	1
	1	Clean Half	1	TC Front	1	Chorus Clean	2
	2	Mid Tone Gt	1	TC Front 2	1	335	1
29	0	Muted Gt	1	TC Mute Gt	1	TC Mute Gt 2	2
	1	Funk Gt	1	FunkGt Slap	2	FunkGt.Slap2	2
	2	Funk Gt 2	1	Funk Pop	1	Funk Pop 2	2
	3	Jazz Man	2	Mute Jazz Gt	2	Slap Jazz Gt	1
30	0	Overdrive Gt	1	Atk Drive Gt	2	OverdriveGt2	2
	1	Gt.Pinrch	1	Gt.Pinrch 2	1	Gt.Pinrch 3	2
31	0	DistortionGt	1	Atk Dist Gt	2	Dist.Gt 2	2
	1	Feedback Gt	2	FeedbackGt 2	3	Feedback OD	3
	2	DistRythm Gt	1	Muted Dist	2	Muted Dist 2	2
32	0	Gt.Harmonics	1	Gt.Harm 2	2	Gt.OctHarm	2
	1	Gt.Feedback	1	FeedbackOct	2	FeedbackHarm	2

Bass

PC	LSB	Classic Set MSB : 96	Voices	Contemp Set MSB : 97	Voices	Solo Set MSB : 98	Voices
33	0	Acoustic Bs	1	Rockabilly	2	Fat Aco.Bass	2
34	0	Fingered Bs	1	Fingered Bs2	1	Jazz Bass	1
	1	FingerJ.Bass	2	FingerP.Bass	2	Finger Slap	2
35	0	Picked Bass	1	Picked Jz Bs	1	Picking Bass	2
36	0	Fretless Bs	1	Fretless Bs2	2	PhaseFrtless	3
37	0	Slap Bass 1	1	Slap Pop 1	1	Jazz Slap	2
38	0	Slap Bass 2	2	Funky Slap	2	Slap Pop 2	2
39	0	Synth Bass 1	2	MG303 Bass	2	Fat Syn.Bass	2
	1	SynthBass101	1	MG Bass	1	SynthSaw Bs	1
	2	Acid Bass	1	MG Acid Bass	1	AcidBs Dirty	1
	3	Clavi Bass	2	Clavi Bass 2	2	Clavi Bass 3	2
	4	Hammer	2	OB Hammer	2	MG Hammer	2
40	0	Synth Bass 2	2	Seq101 Bass	2	Sq SynthBass	2
	1	Beef FM Bs	2	Beef Slap Bs	2	Beef Saw Bs	3
	2	Rubber Bass	2	Rubber Bass2	3	JpSaw Rubber	2
	3	Attack Pulse	1	Attack Saw	1	Attack MG Bs	2

Strings / orchestra

PC	LSB	Classic Set MSB : 96	Voices	Contemp Set MSB : 97	Voices	Solo Set MSB : 98	Voices
41	0	Violin	1	Violin vib	1	Violin 2 vib	1
	1	Slow Violin	1	Slow Vln vib	1	SlowVln2 vib	1
42	0	Viola	1	Viola vib	1	Viola2 vib	1
43	0	Cello	1	Cello vib	1	Cello2 vib	1
44	0	Contrabass	1	Cb vib	1	Cb2 vib	1
45	0	Tremolo Str	2	Tremolo Str2	3	St.Trem Str	2
46	0	Pizzicato	1	Pizzicato 2	2	St.Pizzicato	3
47	0	Harp	1	Harp 2	2	St.Harp	3
	1	Yangqin	1	Yangqin 2	2	St.Yangqin	3
48	0	Timpani	1	Timpani 2	2	St.Timpani	3

Ensemble

PC	LSB	Classic Set MSB : 96	Voices	Contemp Set MSB : 97	Voices	Solo Set MSB : 98	Voices
49	0	Strings	2	Strings 2	3	St.Strings	2
	1	Orchestra	2	Orchestra 2	3	St.Orchestra	5
	2	60' Strings	2	Oct.Strings	2	St.OctStr 1	6
50	0	Slow Strings	1	SlowStrings2	2	St.Slow Str	2
51	0	Syn.Strings1	2	BriteSyn.Str	2	StackSyn.Str	3
	1	Syn.Strings3	3	Oct.SynStr 1	4	Oct.SynStr 2	7
52	0	Syn.Strings2	2	Warm SynStr1	4	Warm SynStr2	6
53	0	Choir Aahs	1	Large Choir	2	St.ChoirAahs	4
	1	Choir Aahs 2	2	Small Choir	2	St.Sm Choir	2
54	0	Voices Oohs	1	Voices Oohs 2	2	St.Vox Oohs	3
	1	Hamming	2	Hamming 2	2	St.Hamming	4
55	0	SynVox	1	SynVox 2	1	St.SynVox	2
	1	Ana Voices	1	Ana Voices 2	1	Ana Voices 3	2
56	0	Orchestrahit	2	Orc Hit 2	2	St.Orc Hit	3
	1	Bass Hit	3	Bass Hit 2	2	St.Bass Hit	3
	2	6th Hit	2	6th Hit 2	2	St.6th Hit	4
	3	Euro Hit	2	Euro Hit 2	2	St.Euro Hit	4

Brass

PC	LSB	Classic Set MSB : 96	Voices	Contemp Set MSB : 97	Voices	Solo Set MSB : 98	Voices
57	0	Trumpet	1	Solo Trumpet	1	Romantic Tp	1
	1	Dark Trumpet	1	Mild Trumpet	2	Tp.Dark vib	1
58	0	Trombone	1	Solo Bone	1	Trombone vib	1
	1	Trombone 2	1	Solo Bone 2	1	Trombone2vib	1
	2	Brite Bone	1	Brite Bone 2	2	Br.Bone vib	2
59	0	Tuba	1	Tuba 2	2	Tuba vib	2
60	0	MuteTrumpet	1	MuteTrumpet2	1	Solo MutedTp	2
	1	MuteTrumpet2	1	Harmon Mute	2	Harmon Mute2	2
61	0	French Horns	1	FrenchHorns2	2	St.Fr Horns	3
	1	Fr.Horn	2	MildFr.Horns	2	St.Fr Horns2	3
62	0	Brass 1	2	Brass FF	2	St.Brass	2
	1	Brass 2	2	BrassSection	3	St.Brass 2	5
63	0	SynthBrass 1	2	JP Syn.Brass	3	Hyper Brass	4
	1	SynthBrass 3	2	JPSyn.Brass2	2	Stack Brass	4
	2	Oct.SynBrass	2	OctSynBrass2	3	OctSynBrass3	3
	3	Jump Brass	1	80's Brass	1	SuperSaw Brs	3
64	0	SynthBrass 2	2	MG Syn.Horn	2	Warm SynHorn	3
	1	SynthBrass 4	2	OB Syn.Horn	2	Rich SynHorn	5
	2	Velo Brass	2	CS Syn.Brass	2	P5 Syn.Brass	3

Reed

PC	LSB	Classic Set MSB : 96	Voices	Contemp Set MSB : 97	Voices	Solo Set MSB : 98	Voices
65	0	Soprano Sax	1	Soprano Sax2	1	Sop.Sax vib	1
66	0	Alto Sax	1	Breathy Alto	1	AltoSoft vib	1
67	0	Tenor Sax	1	BreathyTenor	1	Blow Tenor	1
68	0	Bariton Sax	1	Barely Bari	1	Bari.Sax vib	1
69	0	Oboe	1	Brite Oboe	1	Classic Oboe	1
70	0	EnglishHorn	1	EnglishHorn2	1	E.Horn vib	2
71	0	Bassoon	1	Bassoon 2	1	Bassoon vib	1
72	0	Clarinet	1	Br.Clarinet	1	JazzClarinet	1

Pipe

PC	LSB	Classic Set MSB : 96	Voices	Contemp Set MSB : 97	Voices	Solo Set MSB : 98	Voices
73	0	Piccolo	1	Piccolo 2	1	Piccolo vib	1
74	0	Flute	1	Flute 2	1	Flute vib	1
75	0	Recorder	1	Recorder 2	2	Recorder vib	1
76	0	Pan Flute	2	Pan Flute 2	2	PanFlute vib	2
77	0	Bottle Blow	2	Bottle Blow2	2	Bottle vib	3

78	0	Shakuhachi	2	Shakuhachi 2	3	Shaku.vib	1	
79	0	Whistle	1	Whistle 2	1	Whistle vib	1	99
80	0	Ocarina	1	Ocarina 2	1	Ocarina vib	1	99

Synth lead

PC	LSB	Classic Set MSB: 96	Voices	Contemp Set MSB : 97	Voices	Solo Set MSB : 98	Voices
81	0	Square Wave	2	MG Square	2	OB Square	3
	1	Square	1	Fat Square	3	Fat Square2	3
	2	Sine Wave	1	2600 Sine	1	2600 Sine 2	2
82	0	Saw Wave	1	JP Saw Wave	2	Oct.JP Saw	3
	1	Saw	1	MG Saw	2	Hybrid Saw	3
	2	Doctor Solo	1	Fat Saw Solo	2	Hybrid Solo	3
	3	Natural Lead	2	P5 Saw Lead	2	MG Saw Lead	3
	4	SequencedSaw	2	MG Sequence	2	DelaySequence	2
83	0	Syn.Calliope	2	SynCalliope2	3	SynCalliope3	4
84	0	Chiffer Lead	2	ChifferLead2	4	ChifferLead3	6
85	0	Charang	3	Charang 2	3	Charang 3	4
	1	Wire Lead	2	Wire Lead 2	3	Wire Lead 3	4
86	0	Solo Vox	4	Solo Vox 2	6	Solo Vox 3	5
87	0	5th SawWave	3	5th SawWave2	3	5th SawWave3	6
88	0	Bass & Lead	2	Bass & Lead2	2	Bass & Lead3	4
	1	DelayedLead	2	DelayedLead2	2	DelayedLead3	3

Synth pad, etc

PC	LSB	Classic Set MSB: 96	Voices	Contemp Set MSB : 97	Voices	Solo Set MSB : 98	Voices
89	0	Fantasia	2	Fantasia 2	3	Fantasia 3	4
90	0	Warm Pad	2	Warm Pad 2	2	Warm Pad 3	4
	1	Sine Pad	2	Sine Pad 2	2	Sine Pad 3	3
91	0	Polysynth	2	Polysynth 2	2	Polysynth 3	3
92	0	SpaceVoices	1	SpaceVoices 2	3	SpaceVoices 3	5
	1	Itopia	2	Itopia 2	3	Itopia 3	5
93	0	BowedGlass	2	BowedGlass 2	3	BowedGlass 3	3
94	0	Metal Pad	3	Metal Pad 2	4	Metal Pad 3	4
95	0	Halo Pad	3	Halo Pad 2	4	Halo Pad 3	6
96	0	Sweep Pad	2	Sweep Pad 2	2	Sweep Pad 3	4

Synth SFX

PC	LSB	Classic Set MSB: 96	Voices	Contemp Set MSB : 97	Voices	Solo Set MSB : 98	Voices
97	0	Ice Rain	2	Ice Rain 2	3	Ice Rain 3	4
98	0	Soundtrack	2	Soundtrack 2	2	Soundtrack 3	5
99	0	Crystal	2	Crystal 2	3	Crystal 3	4
	1	Syn Mallet	2	Syn Mallet 2	3	Syn Mallet 3	3
100	0	Atmosphere	2	Atmosphere 2	3	Atmosphere 3	5
101	0	Brightness	2	Brightness 2	4	Brightness 3	6
102	0	Goblin	2	Goblin 2	3	Goblin 3	4
103	0	Echo Drops	1	Echo Drops 2	2	Echo Drops 3	6
	1	Echo Bell	2	Echo Bell 2	3	Echo Bell 3	5
	2	Echo Pan	3	Echo Pan 2	3	Echo Pan 3	6
104	0	Star Theme	2	Star Theme 2	3	Star Theme 3	5

Ethnic, etc

PC	LSB	Classic Set MSB: 96	Voices	Contemp Set MSB : 97	Voices	Solo Set MSB : 98	Voices
105	0	Sitar	1	Atk Sitar	2	St.Sitar	3
	1	Sitar 2	2	Atk Sitar 2	3	St.Sitar 2	4
106	0	Banjo	1	Banjo 2	2	St.Banjo	3
107	0	Shamisen	1	Shamisen 2	2	St.Shamisen	3
108	0	Koto	1	Koto 2	2	St.Koto	3

1	Taisho Koto	1	Taisho Koto2	2	St.T Koto	3	
109	0	Kalimba	1	Kalimba 2	1	St.Kalimba	3
110	0	Bag Pipe	1	Bag Pipe 2	1	St.Bag Pipe	3
111	0	Fiddle	1	Fiddle vib	1	Fiddle 2 vib	1
112	0	Shanai	1	Shanai 2	1	St.Shanai	3

Percussive

PC	LSB	Classic Set MSB : 96	Voices	Contemp Set MSB : 97	Voices	Solo Set MSB : 98	Voices
113	0	Tinkle Bell	1	→		→	
114	0	Agogo	1	→		→	
115	0	Steel Drums	1	→		→	
116	0	Woodblock	1	→		→	
	1	Castanet	1	→		→	
117	0	Taiko	3	→		→	
	1	Concert BD	1	→		→	
118	0	Melo.Tom 1	2	→		→	
	1	Melo.Tom 2	1	→		→	
119	0	Synth Drum	1	→		→	
	1	808 tom	2	→		→	
	2	Elec Perc	2	→		→	
120	0	Reverse Cym	1	→		→	

SFX

PC	LSB	Classic Set MSB : 96	Voices	Contemp Set MSB : 97	Voices	Solo Set MSB : 98	Voices
121	0	GtFret Noise	1	→		→	
	1	Gt.Cut Noise	1	→		→	
	2	Slap_St.Bass	1	→		→	
122	0	Breath Noise	1	→		→	
	1	Fl.Key Click	1	→		→	
123	0	Seashore	2	→		→	
	1	Rain	2	→		→	
	2	Thunder	2	→		→	
	3	Wind	2	→		→	
	4	Stream	2	→		→	
	5	Bubble	2	→		→	
124	0	Bird Tweet	2	→		→	
	1	Dog	1	→		→	
	2	Horse Gallop	1	→		→	
	3	Bird Tweet 2	1	→		→	
125	0	Telephone	1	→		→	
	1	Telephone 2	1	→		→	
	2	Door Creak	1	→		→	
	3	Door	1	→		→	
	4	Scratch	1	→		→	
	5	Wind Chimes	2	→		→	
126	0	Helicopter	1	→		→	
	1	Car-Engine	1	→		→	
	2	Car-Stop	1	→		→	
	3	Car-Pass	1	→		→	
	4	Car-Crash	2	→		→	
	5	Siren	1	→		→	
	6	Train	1	→		→	
	7	Jetplane	3	→		→	
	8	Starship	4	→		→	
	9	Burst Noise	2	→		→	
127	0	Applause	2	→		→	
	1	Laughing	1	→		→	
	2	Screaming	1	→		→	
	3	Punch	1	→		→	
	4	Heart Beat	1	→		→	
	5	Footsteps	1	→		→	
128	0	Gunshot	1	→		→	
	1	Machine Gun	1	→		→	
	2	Lasergun	1	→		→	
	3	Explosion	2	→		→	

Instrument list (GS mode)

Piano

PC	CC00	GS Set	Voices
001	000	Piano 1	1
	008	Piano 1w	1
	016	Piano 1d	1
002	000	Piano 2	1
	008	Piano 2w	1
003	000	Piano 3	1
	008	Piano 3w	1
004	000	Honky-tonk	2
	008	HonkyTonk w	2
005	000	E.Piano 1	1
	008	Detuned EP1	2
	016	E.Piano 1v	2
	024	60s E.Piano	1
006	000	E.Piano 2	1
	008	Detuned EP2	2
	016	E.Piano 2v	2
007	000	Harpsichord	1
	008	Coupled Hps	2
	016	Harpsi.w	1
	024	Harpsi.o	2
008	000	Clav.	1

Chromatic percussion

PC	CC00	GS Set	Voices
009	000	Celesta	1
010	000	Glockenspl	1
011	000	Music Box	1
012	000	Vibraphone	1
	008	Vib.w	1
013	000	Marimba	1
	008	Marimba w	1
014	000	Xylophone	1
015	000	Tubularbell	1
	008	Church Bell	1
	009	Carillon	1
016	000	Santur	1

Organ

PC	CC00	GS Set	Voices
017	000	Organ 1	1
	008	Detuned Or1	2
	016	60's Organ1	1
	032	Organ 4	2
018	000	Organ 2	1
	008	Detuned Or2	2
	032	Organ 5	2
019	000	Organ 3	2
020	000	Church Org1	1
	008	Church Org2	2
	016	Church Org3	2
021	000	Reed Organ	1
022	000	Accordion F	2
	008	Accordion I	2
023	000	Harmonica	1
024	000	Bandoneon	2

Guitar

PC	CC00	GS Set	Voices
025	000	Nylon Gt.	1
	008	Ukulele	1
	016	Nylon Gt.o	2
	032	Nylon Gt.2	1
026	000	Steel Gt.	1
	008	12-str.Gt	2
	016	Mandolin	1
027	000	Jazz Gt.	1
	008	Hawaiian Gt	1
028	000	Clean Gt.	1
	008	Chorus Gt.	2
029	000	Muted Gt.	1
	008	Funk Gt.	1
	016	Funk Gt.2	1
030	000	OverdriveGt	1
031	000	Dist.Gt.	1
	008	Feedback Gt	2
032	000	Gt.Harmonix	1
	008	Gt.Feedback	1

Bass

PC	CC00	GS Set	Voices
033	000	Acoustic Bs	1
034	000	Fingered Bs	1
035	000	Picked Bass	1
036	000	Fretless Bs	1
037	000	Slap Bass 1	1
038	000	Slap Bass 2	1
039	000	Syn.Bass 1	1
	001	Syn.Bass101	1
	008	Syn.Bass 3	1
040	000	Syn.Bass 2	2
	008	Syn.Bass 4	2
	016	Rubber Bass	2

Strings / orchestra

PC	CC00	GS Set	Voices
041	000	Violin	1
	008	Slow Violin	1
042	000	Viola	1
043	000	Cello	1
044	000	Contrabass	1
045	000	Tremolo Str	1
046	000	Pizzicato	1
047	000	Harp	1
048	000	Timpani	1

Ensemble

PC	CC00	GS Set	Voices
049	000	Strings	1
	008	Orchestra	2
050	000	SlowStrings	1
051	000	SynStrings1	1
	008	SynStrings3	2
052	000	SynStrings2	2
053	000	Choir Aahs	1
	032	Choir Aahs2	1
054	000	Voice Oohs	1
055	000	SynVox	1
056	000	Orchest.Hit	2

Brass

PC	CC00	GS Set	Voices
057	000	Trumpet	1
058	000	Trombone	1
	001	Trombone 2	2
059	000	Tuba	1
060	000	MuteTrumpet	1
061	000	French Horn	2
	001	Fr.Horn 2	2
062	000	Brass 1	1
	008	Brass 2	2
063	000	Syn.Brass 1	2
	008	Syn.Brass 3	2
	016	Analog Brs1	2
064	000	Syn.Brass 2	2
	008	Syn.Brass 4	1
	016	Analog Brs2	2

Reed

PC	CC00	GS Set	Voices
065	000	Soprano Sax	1
066	000	Alto Sax	1
067	000	Tenor Sax	1
068	000	BaritoneSax	1
069	000	Oboe	1
070	000	EnglishHorn	1
071	000	Bassoon	1
072	000	Clarinet	1

Pipe

PC	CC00	GS Set	Voices
073	000	Piccolo	1
074	000	Flute	1
075	000	Recorder	1
076	000	Pan Flute	1
077	000	Bottle Blow	2
078	000	Shakuhachi	2
079	000	Whistle	1
080	000	Ocarina	1

Synth lead

PC	CC00	GS Map	Voices
081	000	Square Wave	2
	001	Square	1
	008	Sine Wave	1
082	000	Saw Wave	2
	001	Saw	1
	008	Doctor Solo	2
083	000	SynCalliope	2
084	000	ChifferLead	2
085	000	Charang	2
086	000	Solo Vox	2
087	000	5th Saw	2
088	000	Bass & Lead	2

Synth pad, etc

PC	CC00	GS Set	Voices
089	000	Fantasia	2
090	000	Warm Pad	1
091	000	Polysynth	2
092	000	Space Voice	1
093	000	Bowed Glass	2
094	000	Metal Pad	2
095	000	Halo Pad	2
096	000	Sweep Pad	1

Synth SFX

PC	CC00	GS Set	Voices
097	000	Ice Rain	2
098	000	Soundtrack	2
099	000	Crystal	2
100	000	Atmosphere	2
101	000	Brightness	2
102	000	Goblin	2
103	000	Echo Drops	1
	001	Echo Bell	2
	002	Echo Pan	2
104	000	Star Theme	2

Ethnic, etc

PC	CC00	GS Set	Voices
105	000	Sitar	1
	001	Sitar 2	2
106	000	Banjo	1
107	000	Shamisen	1
108	000	Koto	1
	008	Taisho Koto	2
109	000	Kalimba	1
110	000	Bagpipe	1
111	000	Fiddle	1
112	000	Shanai	1

Percussive

PC	CC00	GS Set	Voices
113	000	Tinkle Bell	1
114	000	Agogo	1
115	000	Steel Drums	1
116	000	Woodblock	1
	008	Castanets	1
117	000	Taiko	1
	008	Concert BD	1
118	000	Melo. Tom 1	1
	008	Melo. Tom 2	1
119	000	Synth Drum	1
	008	808 Tom	1
	009	Elec Perc	1
120	000	Reverse Cym	1

SFX

PC	CC00	GS Set	Voices
121	000	Gt.FretNoiz	1
	001	Gt.CutNoise	1
	002	String Slap	1
122	000	BreathNoise	1
	001	Fl.KeyClick	1
123	000	Seashore	1
	001	Rain	1
	002	Thunder	1
	003	Wind	1
	004	Stream	2
	005	Bubble	2
124	000	Bird	2
	001	Dog	1
	002	HorseGallop	1
	003	Bird 2	1
125	000	Telephone 1	1
	001	Telephone 2	1
	002	Creaking	1
	003	Door	1
	004	Scratch	1
	005	Wind Chimes	2
126	000	Helicopter	1
	001	Car-Engine	1
	002	Car-Stop	1
	003	Car-Pass	1
	004	Car-Crash	2
	005	Siren	1
	006	Train	1
	007	Jetplane	2
	008	Starship	2
	009	Burst Noise	2
127	000	Applause	2
	001	Laughing	1
	002	Screaming	1
	003	Punch	1
	004	Heart Beat	1
	005	Footsteps	1
128	000	Gun Shot	1
	001	Machine Gun	1
	002	Lasergun	1
	003	Explosion	2

Instrument list (XGlite mode)

* The instrument names listed here are the proper names for the XGlite sound module mode. Due to the limited number of letters that can be used for the display, the names shown in the display may be slightly different from the instrument names listed here.

Piano

PC	CC00	XG Set	Elements
001	000	Grand Piano	1
	001	Grand Piano KSP	1
	040	Piano Strings	2
	041	Dream	2
002	000	Bright Piano	1
	001	Bright Piano KSP	1
003	000	Electric Grand Piano	2
	001	Electric Grand Piano KSP	2
	032	Detuned CP80	2
004	000	Honky-tonk Piano	2
	001	Honky-tonk Piano KSP	2
005	000	Electric Piano 1	2
	001	Electric Piano 1 KSP	1
	032	Chorus Electric Piano 1	2
006	000	Electric Piano 2	2
	001	Electric Piano 2 KSP	1
	041	DX + Analog Electric Piano	2
	085	Tinker DX Plus	2
007	000	Harpsichord	1
	001	Harpsichord KSP	1
	035	Harpsichord 3	2
008	000	Clavi	2
	001	Clavi KSP	1

Chromatic percussion

PC	CC00	XG Set	Elements
009	000	Celesta	1
010	000	Glockenspiel	1
011	000	Music Box	2
	064	Orgel	2
012	000	Vibraphone	1
	001	Vibraphone KSP	1
013	000	Marimba	1
	001	Marimba KSP	1
	064	Sine Marimba	2
	097	Balimba	2
	098	Log Drums	2
014	000	Xylophone	1
015	000	Tubular Bells	1
	096	Church Bells	2
	097	Carillon	2
016	000	Dulcimer	1
	035	Dulcimer 2	2
	096	Cimbalom	2
	097	Santur	2

Organ

PC	CC00	XG Set	Elements
017	000	Drawbar Organ	1
	032	Detuned Drawbar Organ	2
	033	60's Drawbar Organ 1	2
	034	60's Drawbar Organ 2	2
	035	70's Drawbar Organ 1	2
	037	60's Drawbar Organ 3	2
	040	16+2"2/3	2
	064	Organ Bass	1
	065	70's Drawbar Organ 2	2
	066	Cheezy Organ	2
	067	Drawbar Organ 3	2
018	000	Percussive Organ	1

	024	70's Percussive Organ 1	2
	032	Detuned Percussive Organ	2
	033	Light Organ	2
	037	Percussive Organ 2	2
019	000	Rock Organ	2
	064	Rotary Organ	2
	065	Slow Rotary	2
	066	Fast Rotary	2
020	000	Church Organ	2
	032	Church Organ 3	2
	035	Church Organ 2	2
	040	Notre Dame	2
	064	Organ Flute	2
	065	Tremolo Organ Flute	2
021	000	Reed Organ	1
	040	Puff Organ	2
022	000	Accordion	2
023	000	Hamonica	1
	032	Hamonica 2	2
024	000	Tango Accordion	2
	064	Tango Accordion 2	2

Guitar

PC	CC00	XG Set	Elements
025	000	Nylon Guitar	1
	043	Velocity Guitar Harmonics	2
	096	Cimbalom	2
026	000	Steel Guitar	1
	035	12-string Guitar	2
	040	Nylon & Steel Guitar	2
	041	Steel Guitar with Body Sound2	2
	096	Mandolin	2
027	000	Jazz Guitar	1
	032	Jazz Amp	2
028	000	Clean Guitar	1
	032	Chorus Guitar	2
029	000	Muted Guitar	1
	040	Funk Guitar 1	2
	041	Muted Steel Guitar	2
	045	Jazz Man	1
030	000	Overdriven Guitar	1
	043	Guitar Pinch	2
031	000	Distortion Guitar	1
	040	Feedback Guitar	2
	041	Feedback Guitar 2	2
032	000	Guitar Harmonics	1
	065	Guitar Feedback	1
	066	Guitar Harmonics 2	1

Bass

PC	CC00	XG Set	Elements
033	000	Acoustic Bass	1
	040	Jazz Rhythm	2
	045	Velocity Crossfade Upright Bass	2
034	000	Finger Bass	1
	018	Finger Dark	2
	040	Bass & Distorted Electric Guitar2	2
	043	Finger Slap Bass	2
	045	Finger Bass 2	2
	065	Modulated Bass	2
035	000	Pick Bass	1
	028	Muted Pick Bass	1

036	000	Fretless Bass	1
	032	Fretless Bass 2	2
	033	Fretless Bass 3	2
	034	Fretless Bass 4	2
037	000	Slap Bass 1	1
	032	Punch Thumb Bass	2
038	000	Slap Bass 2	1
	043	Velocity Switch Slap	2
039	000	Synth Bass 1	1
	040	Techno Synth Bass	2
	085	SweepPWM	2
040	000	Synth Bass 2	2
	006	Mellow Synth Bass	1
	012	Sequenced Bass	2
	018	Click Synth Bass	2
	019	Synth Bass 2 Dark	1
	041	DX Bass	2

Strings / orchestra

PC	CC00	XG Set	Elements
041	000	Violin	1
	008	Slow Violin	1
042	000	Viola	1
043	000	Cello	1
044	000	Contrabass	1
045	000	Tremolo Strings	1
	008	Slow Tremolo Strings	1
	040	Suspense Strings	2
046	000	Pizzicato Strings	1
047	000	Orchestral Harp	1
	040	Yang Chin	2
048	000	Timpani	1

Ensemble

PC	CC00	XG Set	Elements
049	000	Strings 1	1
	003	Stereo Strings	2
	008	Slow Strings	1
	035	60's Strings	2
	040	Orchestra	2
	041	Orchestra 2	2
	042	Tremolo Orchestra	2
	045	Velocity Strings	2
050	000	Strings 2	1
	003	Stereo Slow Strings	2
	008	Legato Strings	2
	040	Warm Strings	2
	041	Kingdom	2
051	000	Synth Strings 1	2
052	000	Synth Strings 2	2
053	000	Choir Aahs	1
	003	Stereo Choir	2
	032	Mellow Choir	2
	040	Choir Strings	2
054	000	Voice Oohs	1
055	000	Synth Voice	1
	040	Synth Voice 2	2
	041	Choral	2
	064	Analog Voice	1
056	000	Orchestra Hit	2
	035	Orchestra Hit 2	2
	064	Impact	2

Brass

PC	CC00	XG Set	Elements
057	000	Trumpet	1
	032	Warm Trumpet	2
058	000	Trombone	1
	018	Trombone 2	
059	000	Tuba	1
060	000	Muted Trumpet	1
061	000	French Horn	1
	006	French Horn Solo	1
	032	French Horn 2	2
	037	Horn Orchestra	2
062	000	Brass Section	1
	035	Trumpet & Trombone Section	2
063	000	Synth Brass 1	2
	020	Resonant Synth Brass	2
064	000	Synth Brass 2	1
	018	Soft Brass	2
	041	Choir Brass	2

Reed

PC	CC00	XG Set	Elements
065	000	Soprano Sax	1
066	000	Alto Sax	1
	040	Sax Section	2
067	000	Tenor Sax	1
	040	Breathy Tenor Sax	2
068	000	Baritone Sax	1
069	000	Oboe	2
070	000	English Horn	1
071	000	Bassoon	1
072	000	Clarinet	1

Pipe

PC	CC00	XG Set	Elements
073	000	Piccolo	1
074	000	Flute	1
075	000	Recorder	1
076	000	Pan Flute	1
077	000	Blown Bottle	2
078	000	Shakuhachi	2
079	000	Whistle	1
080	000	Ocarina	1

Synth lead

PC	CC00	XG Set	Elements
081	000	Square Lead	2
	006	Square Lead 2	1
	008	LM Square	2
	018	Hollow	1
	019	Shroud	2
	064	Mellow	2
	065	Solo Sine	2
	066	Sine Lead	1
082	000	Sawtooth Lead	2
	006	Sawtooth Lead 2	1
	008	Thick Sawtooth	2
	018	Dynamic Sawtooth	1
	019	Digital Sawtooth	2
	020	Big Lead	2
	096	Sequenced Analog	2
083	000	Calliope Lead	2
	065	Pure Pad	2
084	000	Chiff Lead	2

085	000	Charang Lead	2
	064	Distorted Lead	2
086	000	Voice Lead	2
087	000	Fifths Lead	2
	035	Big Five	2
088	000	Bass & Lead	2
	016	Big & Low	2
	064	Fat & Perky	2
	065	Soft Whirl	2
	067	Mogul	1
	068	Distance	2

Synth pad, etc

PC	CC00	XG Set	Elements
089	000	New Age Pad	2
	064	Fantasy	2
090	000	Warm Pad	2
091	000	Poly Synth Pad	2
092	000	Choir Pad	2
	066	Itopia	2
093	000	Bowed Pad	2
094	000	Metallic Pad	2
095	000	Halo Pad	2
096	000	Sweep Pad	2

Synth SFX

PC	CC00	XG Set	Elements
097	000	Rain	2
	065	African Wind	2
	066	Carib	2
098	000	Sound Track	2
	027	Prologue	2
099	000	Crystal	2
	012	Synth Drum Comp	2
	014	Popcorn	2
	018	Tiny Bells	2
	035	Round Glockenspiel	2
	040	Glockenspiel Chimes	2
	041	Clear Bells	2
	042	Chorus Bells	2
	065	Soft Crystal	2
	070	Air Bells	2
	071	Bell Harp	2
	072	Gamelimba	2
100	000	Atmosphere	2
	018	Warm Atmosphere	2
	019	Hollow Release	2
	040	Nylon Electric Piano	2
	064	Nylon Harp	2
	065	Harp Vox	2
	066	Atmosphere Pad	2
101	000	Brightness	2
102	000	Goblins	2
	064	Goblins Synth	2
	065	Creeper	2
	067	Ritual	2
	068	To Heaven	2
	070	Night	2
	071	Glisten	2
	096	Bell Choir	2
103	000	Echoes	2
104	000	Sci-Fi	2

Ethnic, etc

PC	CC00	XG Set	Elements
105	000	Sitar	1
	032	Detuned Sitar	2
	035	Sitar 2	2
	097	Tamboura	2
106	000	Banjo	1
	028	Muted Banjo	1
	096	Rabab	2
	097	Gopichant	2
	098	Oud	2
107	000	Shamisen	1
108	000	Koto	1
	096	Taisho-kin	2
	097	Kanoon	2
109	000	Kalimba	1
110	000	Bagpipe	2
111	000	Fiddle	1
112	000	Shanai	1
113	000	Tinkle Bell	2
	096	Bonang	2
	097	Altair	2
	098	Gamelan Gongs	2
	099	Stereo Gamelan Gongs	2
	100	Rama Cymbal	2
114	000	Agogo	2
115	000	Steel Drums	2
	097	Glass Percussion	2
	098	Thai Bells	2
116	000	Woodblock	1
	096	Castanets	1
117	000	Taiko Drum	1
	096	Gran Cassa	1
118	000	Melodic Tom	2
	064	Melodic Tom 2	1
	065	Real Tom	2
	066	Rock Tom	2
119	000	Synth Drum	1
	064	Analog Tom	1
	065	Electronic Percussion	2
120	000	Reverse Cymbal	1
121	000	Fret Noise	2
122	000	Breath Noise	2
123	000	Seashore	2
124	000	Bird Tweet	2
125	000	Telephone Ring	1
126	000	Helicopter	1
127	000	Applause	1
128	000	Gunshot	1

SFX

Drum set list (GM2 / Native mode)

PC	MSB	Classical Set	MSB	Contemporary Set	MSB	Solo Set
001	104	Standard Set	105	StandardSet2	106	St.Standard
009	104	Room Set	105	Room Set 2	106	St.Room
017	104	Power Set	105	Power Set 2	106	St.Power
025	104	Electric Set	105	Dance Set	106	Rust Set
026	104	Analog Set	105	Rave Set	106	Analog2 Set
033	104	Jazz Set	105	Jazz Set 2	106	St.Jazz
041	104	Brush Set	105	Brush Set 2	106	St.Brush
049	104	OrchestraSet	105	<-	106	<-
057	104	SFX Set	105	<-	106	<-

Classical set drum set (1)

<-: Same as the percussion sound of "Standard Set" (PC001)

* BANK MSB=104, LSB=0

	PC001	PC009	PC017	PC025	PC026
	Standard Set	Room Set	Power Set	Erectric Set	Analog Set
28	27	High Q	<-	<-	<-
		Slap	<-	<-	<-
29		Scratch Push	<-	<-	<-
	30	Scratch Pull	<-	<-	<-
31		Sticks	<-	<-	<-
	32	Square Click	<-	<-	<-
33		Metron Click	<-	<-	<-
	34	Metron Bell	<-	<-	<-
35		Kick Drum 2	<-	Power Kick 2	Elec.Kick 2
					Ana.Kick 2
C2	36	Kick Drum 1	<-	Power Kick 1	Elec.Kick 1
					Ana.Kick 1
	37	Side Stick	<-	<-	Ana.Rim Sho
38		Aco.Snare	Room Snare	PowerSnareDr	E.SnareDrum1
					Ana.Snare 1
	39	Hand Clap	<-	<-	<-
40		Elec.Snare	<-	<-	E.SnareDrum2
					Elec.Snare
41		Low Tom 2	Room LowTom2	PowerLowTom2	E.Low Tom 2
					Ana.Low Tom2
	42	ClosedHi-hat	<-	<-	<-
43		Low Tom 1	Room LowTom1	PowerLowTom1	E.Low Tom 1
					Ana.Low Tom1
	44	Pedal Hi-hat	<-	<-	ClosedHi-hat
45		Mid Tom 2	Room MidTom2	PowerMidTom2	E.Mid Tom 2
					Ana.Mid Tom2
	46	Open Hi-hat	<-	<-	Closed Hi-ha
47		Mid Tom 1	Room MidTom1	PowerMidTom1	E.Mid Tom 1
					Ana.Mid Tom1
C3	48	High Tom 2	Room Hi Tom2	Power HiTom2	E.Hi Tom 2
					Ana.Hi Tom2
	49	CrashCymbal1	<-	<-	<-
					Ana.Cymbal
50		High Tom 1	Room Hi Tom1	Power HiTom1	E.Hi Tom 1
					Ana.Hi Tom1
	51	Ride Cymbal1	<-	<-	<-
52		China Cymbal	<-	<-	Reverse Cym.
					<-
53		Ride Bell	<-	<-	<-
	54	Tambourine	<-	<-	<-
55		SplashCymbal	<-	<-	<-
	56	Cowbell	<-	<-	<-
					Ana.Cowbell
57		CrashCymbal2	<-	<-	<-
	58	Vibra-slap	<-	<-	<-
59		Ride Cymbal2	<-	<-	<-
C4	60	High Bongo	<-	<-	<-
		Low Bongo	<-	<-	<-
62		MuteHi Conga	<-	<-	<-
					Ana.Hi Conga
	63	OpenHi Conga	<-	<-	<-
					Ana.MidConga
64		Low Conga	<-	<-	<-
					Ana.LowConga
65		High Timbale	<-	<-	<-
	66	Low Timbale	<-	<-	<-
67		High Agogo	<-	<-	<-
	68	Low Agogo	<-	<-	<-
69		Cabasa	<-	<-	<-
	70	Maracas	<-	<-	<-
					Ana.Maracas
71		ShortWhistle	<-	<-	<-
C5	72	Long Whistle	<-	<-	<-
					<-
	73	Short Guiro	<-	<-	<-
74		Long Guiro	<-	<-	<-
					<-
	75	Claves	<-	<-	<-
					Ana.Claves
76		Hi WoodBlock	<-	<-	<-
					<-
77		LowWoodBlock	<-	<-	<-
	78	Mute Cuica	<-	<-	<-
79		Open Cuica	<-	<-	<-
					<-
	80	MuteTriangle	<-	<-	<-
81		OpenTriangle	<-	<-	<-
	82	Shaker	<-	<-	<-
83		Jingle Bell	<-	<-	<-
C6	84	Bell Tree	<-	<-	<-
					<-
	85	Castanets	<-	<-	<-
86		Mute Surdo	<-	<-	<-
					<-
	87	Open Surdo	<-	<-	<-
88					<-

■ Classical set drum set (2)

* BANK MSB=104, LSB=0

	PC033	PC041	PC049	PC057
	Jazz Set	Brush Set	OrchestraSet	SFX Set
27	<	<	ClosedHi-hat	---
28	<	<	Pedal Hi-hat	---
29	<	<	Open Hi-hat	---
30	<	<	Ride Cymbal1	---
31	<	<	<	---
32	<	<	<	---
33	<	<	<	---
34	<	<	<	---
35	Jazz Kick 2	Jazz Kick 2	Concert BD 2	---
C2 36	Jazz Kick 1	Jazz Kick 1	Concert BD 1	---
37	<	<	<	---
38	<	Brush Tap	Concert SD	---
39	<	Brush Slap	Castanets	High Q
40	<	Brush Swirl	Concert SD	Slap
41	<	BrushLowTom2	Timpani F	Scratch Push
42	<	<	Timpani F#	Scratch Pull
43	<	BrushLowTom1	Timpani G	Sticks
44	<	ClosedHi-hat	Timpani G#	Square Click
45	<	BrushMidTom2	Timpani A	Metron Click
46	<	Closed Hi-ha	Timpani A#	Metron Bell
47	<	BrushMidTom1	Timpani B	GtFret Noise
C3 48	<	Brush HiTom2	Timpani c	Cut Noise Up
49	<	Brush Crash1	Timpani c#	Cut Noise Dw
50	<	Brush HiTom1	Timpani d	Slap_St.Bass
51	<	Brush Ride 1	Timpani d#	Fl.Key Click
52	<	<	Timpani e	Laughing
53	<	BrushRideBel	Timpani f	Scream
54	<	<	<	Punch
55	<	<	<	Heart Beat
56	<	<	<	Footsteps 1
57	<	Brush Crash2	<	Footsteps 2
58	<	<	<	Applause
59	<	<	Concert Cym1	Door Creak
C4 60	<	<	<	Door
61	<	<	<	Scratch
62	<	<	<	Wind Chimes
63	<	<	<	Car-Engine
64	<	<	<	Car-Stop
65	<	<	<	Car-Pass
66	<	<	<	Car-Crash
67	<	<	<	Siren
68	<	<	<	Train
69	<	<	<	Jetplane
70	<	<	<	Helicopter
71	<	<	<	Starship
C5 72	<	<	<	Gun Shot
73	<	<	<	Machine Gun
74	<	<	<	Lasergun
75	<	<	<	Explosion
76	<	<	<	Dog
77	<	<	<	Horse-Gallop
78	<	<	<	Birds
79	<	<	<	Rain
80	<	<	<	Thunder
81	<	<	<	Wind
82	<	<	<	Seashore
83	<	<	<	Stream
C6 84	<	<	<	Bubble
85	<	<	<	<
86	<	<	<	<
87	<	<	<	<
88	<	<	<	<

■ Contemporary set drum set (1)

<: Same as the percussion sound of "StandardSet2" (PC001)

* BANK MSB=105, LSB=0

	PC001	PC009	PC017	PC025	PC026
	StandardSet2	Room Set 2	Power Set 2	Dance Set	Rave Set
28	27	High Q	<	<	<
		Slap	<	<	<
29		Scratch Push	<	<	<
30		Scratch Pull	<	<	<
31		Sticks	<	<	<
	32	Square Click	<	<	<
33		Metron Click	<	<	<
	34	Metron Bell	<	<	<
35		Kick Drum 2	Power Kick 2	Dance Kick	808 Kick
C2 36		Kick Drum 1	Power Kick 1	Techno Kick	Round Kick
	37	Side Stick	<	<	Ana.Rim Shot
38		Aco. Snare	Room Snare	PowerSnareDr	Dance Snare
	39	Hand Clap	<	<	<
40		Elec. Snare	<	Raga Snare	<
41		Low Tom 2	Room LowTom2	PowerLowTom2	Ana.Low Tom2
	42	ClosedHi-hat	<	<	<
43		Low Tom 1	Room LowTom1	PowerLowTom1	Ana.Low Tom1
	44	Pedal Hi-hat	<	<	ClosedHi-hat
45		Mid Tom 2	Room MidTom2	PowerMidTom2	Ana.Mid Tom2
	46	Open Hi-hat	<	<	ClosedHi-hat
C3 47		Mid Tom 1	Room MidTom1	PowerMidTom1	Ana.Mid Tom1
48		High Tom 2	Room Hi Tom2	Power HiTom2	Ana.Hi Tom2
	49	CrashCymbal1	<	<	Ana.Cymbal
50		High Tom 1	Room Hi Tom1	Power HiTom1	Ana.Hi Tom1
	51	Ride Cymbal1	<	<	<
52		China Cymbal	<	<	Reverse Cym.
		Ride Bell	<	<	<
53		Tambourine	<	<	<
	54	SplashCymbal	<	<	<
55		Cowbell	<	<	Ana.Cowbell
	56	CrashCymbal2	<	<	<
57		Vibra-slap	<	<	<
	58	Ride Cymbal2	<	<	<
59		High Bongo	<	<	<
C4 60		Low Bongo	<	<	<
	61	MuteHi Conga	<	<	Ana.Hi Conga
62		OpenHi Conga	<	<	Ana.MidConga
	63	Low Conga	<	<	Ana.LowConga
64		High Timbale	<	<	<
	66	Low Timbale	<	<	<
67		High Agogo	<	<	<
	68	Low Agogo	<	<	<
69		Cabasa	<	<	<
	70	Maracas	<	<	Ana.Maracas
71		ShortWhistle	<	<	<
		Long Whistle	<	<	<
C5 72		Short Guiro	<	<	<
	73	Long Guiro	<	<	<
74		Claves	<	<	Ana.Claves
	75	Hi WoodBlock	<	<	<
76		LowWoodBlock	<	<	<
	78	Mute Cuica	<	<	<
79		Open Cuica	<	<	<
	80	MuteTriangle	<	<	<
81		OpenTriangle	<	<	<
	82	Shaker	<	<	<
83		Jingle Bell	<	<	<
C6 84		Bell Tree	<	<	<
	85	Castanets	<	<	<
86		Mute Surdo	<	<	<
	87	Open Surdo	<	<	<
88					

■ Contemporary set drum set (1)

* BANK MSB=105, LSB=0

	PC033	PC041	PC049	PC057
	Jazz Set 2	Brush Set 2	OrchestraSet	SFX Set
27	<	<	ClosedHi-hat	---
28	<	<	Pedal Hi-hat	---
29	<	<	Open Hi-hat	---
30	<	<	Ride Cymbal1	---
31	<	<	<	---
32	<	<	<	---
33	<	<	<	---
34	<	<	<	---
35	Jazz Kick 2	Jazz Kick 2	Concert BD 2	---
C2 36	Jazz Kick 1	Jazz Kick 1	Concert BD 1	---
37	<	<	<	---
38	Jazz Snare	Brush Tap	Concert SD	---
39	<	Brush Slap	Castanets	High Q
40	<	Brush Swirl	Concert SD	Slap
41	<	BrushLowTom2	Timpani F	Scratch Push
42	<	<	Timpani F#	Scratch Pull
43	<	BrushLowTom1	Timpani G	Sticks
44	<	Closed Hi-ha	Timpani G#	Square Click
45	<	BrushMidTom2	Timpani A	Metron Click
46	<	ClosedHi-hat	Timpani A#	Metron Bell
47	<	BrushMidTom1	Timpani B	GtFret Noise
C3 48	<	Brush HiTom2	Timpani c	Cut Noise Up
49	<	Brush Crash1	Timpani c#	Cut Noise Dw
50	<	Brush HiTom1	Timpani d	Slap_St.Bass
51	<	Brush Ride 1	Timpani d#	Fl.Key Click
52	<	<	Timpani e	Laughing
53	<	BrushRideBel	Timpani f	Scream
54	<	<	<	Punch
55	<	<	<	Heart Beat
56	<	<	<	Footsteps 1
57	<	Brush Crash2	Concert Cym2	Footsteps 2
58	<	<	<	Applause
59	<	<	Concert Cym1	Door Creak
C4 60	<	<	<	Door
61	<	<	<	Scratch
62	<	<	<	Wind Chimes
63	<	<	<	Car-Engine
64	<	<	<	Car-Stop
65	<	<	<	Car-Pass
66	<	<	<	Car-Crash
67	<	<	<	Siren
68	<	<	<	Train
69	<	<	<	Jetplane
70	<	<	<	Helicopter
71	<	<	<	Starship
C5 72	<	<	<	Gun Shot
73	<	<	<	Machine Gun
74	<	<	<	Lasergun
75	<	<	<	Explosion
76	<	<	<	Dog
77	<	<	<	Horse-Gallop
78	<	<	<	Birds
79	<	<	<	Rain
80	<	<	<	Thunder
81	<	<	<	Wind
82	<	<	<	Seashore
83	<	<	<	Stream
C6 84	<	<	<	Bubble
85	<	<	<	<
86	<	<	<	<
87	<	<	<	<
88	<	<	<	<

Solo set drum set (1)

<-: Same as the percussion sound of "St.Standard" (PC001)

* BANK MSB=106, LSB=0

	PC001	PC009	PC017	PC025	PC026
	St.Standard	St.Room	St.Power	Rust Set	Analog2 Set
28	27	High Q	<-	<-	<-
		Slap	<-	<-	<-
29		Scratch Push	<-	<-	<-
	30	Scratch Pull	<-	<-	<-
31		Sticks	<-	<-	<-
	32	Square Click	<-	<-	<-
33		Metron Click	<-	<-	<-
	34	Metron Bell	<-	<-	<-
35		Kick Drum 2	Rock Kick Dr	70s Kick 1	909 Kick 2
C2	36	Kick Drum 1	<-	Round Kick	909 Kick 1
	37	Side Stick	<-	<-	Ana.Rim Shot
38		Snare Drum 1	Rock SnareDr	Rock SnareDr	Old Fill SN
	39	Hand Clap	<-	<-	<-
40		Snare Drum 2	<-	Piccolo SN	909 Snare 2
41		Low Tom 2	Room LowTom2	PowerLowTom2	Elec.Tom L2
	42	ClosedHi-hat	<-	<-	<-
43		Low Tom 1	Room LowTom1	PowerLowTom1	Elec.Tom L1
	44	Pedal Hi-hat	<-	<-	ClosedHi-hat
45		Mid Tom 2	Room MidTom2	PowerMidTom2	Elec.Tom M2
	46	Open Hi-hat	<-	<-	<-
47		Mid Tom 1	Room MidTom1	PowerMidTom1	Elec.Tom M1
C3	48	High Tom 2	Room Hi Tom2	Power HiTom2	Elec.Tom H2
	49	CrashCymbal1	<-	<-	<-
50		High Tom 1	Room Hi Tom1	Power HiTom1	Elec.Tom H1
	51	Ride Cymbal1	<-	<-	<-
52		China Cymbal	<-	<-	Reverse Cym.
		Ride Bell	<-	<-	<-
53		Tambourine	<-	<-	<-
	54	SplashCymbal	<-	<-	<-
55		Cowbell	<-	<-	<-
	56	Cowbell	<-	<-	Ana.Cowbell
57		CrashCymbal2	<-	<-	<-
	58	Vibra-slap	<-	<-	<-
59		Ride Cymbal2	<-	<-	<-
C4	60	High Bongo	<-	<-	<-
	61	Low Bongo	<-	<-	<-
62		MuteHi Conga	<-	<-	<-
	63	OpenHi Conga	<-	<-	Ana.Hi Conga
64		Low Conga	<-	<-	Ana.MidConga
		Low Conga	<-	<-	Ana.LowConga
65		High Timbale	<-	<-	<-
	66	Low Timbale	<-	<-	<-
67		High Agogo	<-	<-	<-
	68	Low Agogo	<-	<-	<-
69		Cabasa	<-	<-	<-
	70	Maracas	<-	<-	<-
71		Maracas	<-	<-	Ana.Maracas
		ShortWhistle	<-	<-	<-
C5	72	Long Whistle	<-	<-	<-
	73	Short Guiro	<-	<-	<-
74		Long Guiro	<-	<-	<-
	75	Claves	<-	<-	<-
76		Claves	<-	<-	Ana.Claves
		Hi WoodBlock	<-	<-	<-
77		LowWoodBlock	<-	<-	<-
	78	Mute Cuica	<-	<-	<-
79		Open Cuica	<-	<-	<-
	80	MuteTriangle	<-	<-	<-
81		OpenTriangle	<-	<-	<-
	82	Shaker	<-	<-	<-
83		Jingle Bell	<-	<-	<-
C6	84	Bell Tree	<-	<-	<-
	85	Castanets	<-	<-	<-
86		Mute Surdo	<-	<-	<-
	87	Open Surdo	<-	<-	<-
88		Open Surdo	<-	<-	<-

■ Solo set drum set (2)

* BANK MSB=106, LSB=0

	PC033	PC041	PC049	PC057
	St.Jazz	St.Brush	OrchestraSet	SFX Set
27	<	<	ClosedHi-hat	---
28	<	<	Pedal Hi-hat	---
29	<	<	Open Hi-hat	---
30	<	<	Ride Cymbal1	---
31	<	<	<	---
32	<	<	<	---
33	<	<	<	---
34	<	<	<	---
35	Jazz Kick 2	Jazz Kick 2	Concert BD 2	---
C2 36	Jazz Kick 1	Jazz Kick 1	Concert BD 1	---
37	<	<	<	---
38	Snare Drum 1	Brush Tap	Concert SD	---
39	<	Brush Slap	Castanets	High Q
40	<	Brush Swirl	Concert SD	Slap
41	<	BrushLowTom2	Timpani F	Scratch Push
42	<	<	Timpani F#	Scratch Pull
43	<	BrushLowTom1	Timpani G	Sticks
44	<	ClosedHi-hat	Timpani G#	Square Click
45	<	BrushMidTom2	Timpani A	Metron Click
46	<	Closed Hi-ha	Timpani A#	Metron Bell
47	<	BrushMidTom1	Timpani B	GtFret Noise
C3 48	<	Brush HiTom2	Timpani c	Cut Noise Up
49	<	Brush Crash1	Timpani c#	Cut Noise Dw
50	<	Brush HiTom1	Timpani d	Slap_St.Bass
51	<	Brush Ride 1	Timpani d#	Fl.Key Click
52	<	<	Timpani e	Laughing
53	<	BrushRideBel	Timpani f	Scream
54	<	<	<	Punch
55	<	<	<	Heart Beat
56	<	<	<	Footsteps 1
57	<	Brush Crash2	<	Footsteps 2
58	<	<	<	Applause
59	<	<	Concert Cym1	Door Creak
C4 60	<	<	<	Door
61	<	<	<	Scratch
62	<	<	<	Wind Chimes
63	<	<	<	Car-Engine
64	<	<	<	Car-Stop
65	<	<	<	Car-Pass
66	<	<	<	Car-Crash
67	<	<	<	Siren
68	<	<	<	Train
69	<	<	<	Jetplane
70	<	<	<	Helicopter
71	<	<	<	Starship
C5 72	<	<	<	Gun Shot
73	<	<	<	Machine Gun
74	<	<	<	Lasergun
75	<	<	<	Explosion
76	<	<	<	Dog
77	<	<	<	Horse-Gallop
78	<	<	<	Birds
79	<	<	<	Rain
80	<	<	<	Thunder
81	<	<	<	Wind
82	<	<	<	Seashore
83	<	<	<	Stream
C6 84	<	<	<	Bubble
85	<	<	<	
86	<	<	<	
87	<	<	<	
88	<	<	<	

Drum set list (GS mode)

* The instrument names listed here are the proper names for the XGlite soundmodule mode. Due to the limited number of letters that can be used for the display, the names shown in the display may be slightly different from the instrument names listed here.

PC	GS Set
001	STANDARD
009	ROOM
017	POWER
025	ELECTRONIC
026	TR-808
033	JAZZ
041	BRUSH
049	ORCHESTRA
057	SFX

■ GS mode drum set (1)

	PC 1 / PC 33 STANDARD / JAZZ	PC 9 ROOM	PC 17 POWER	PC 25 ELECTRONIC	PC 26 TR-808	PC 41 BRUSH	PC 49 ORCHESTRA
25	----	----	----	----	----	----	----
26	----	----	----	----	----	----	----
27	High Q	<-	<-	<-	<-	<-	Closed Hi-hat
28	Slap	<-	<-	<-	<-	<-	Pedal Hi-hat
29	Scratch Push	<-	<-	<-	<-	<-	Open Hi-hat
30	Scratch Pull	<-	<-	<-	<-	<-	Ride Cymbal1
31	Sticks	<-	<-	<-	<-	<-	<-
32	Square Click	<-	<-	<-	<-	<-	<-
33	Metronome Click	<-	<-	<-	<-	<-	<-
34	Metronome Bell	<-	<-	<-	<-	<-	<-
35	Kick Drum2 / Jazz	<-	<-	<-	<-	Jazz BD2	Concert BD2
C36	Kick Drum1 / Jazz	<-	MONDO Kick	Elec BD	808 Bass Drum	Jazz BD1	Concert BD1
37	Side Stick	<-	<-	<-	808 Rim Shot	<-	<-
38	Snare Drum1	<-	Gated SD	Elec SD	808 Snare Drum	Brush Tap	Concert SD
39	Hand Clap	<-	<-	<-	<-	Brush Slap	Castanets
40	Snare Drum2	<-	<-	Gated SD	<-	Brash Swirl	Concert SD
41	Low Tom2	Room Low	Room Low	Elec Low Tom2	808 Low Tom2	<-	Timpani F
42	Closed Hi-hat	<-	<-	<-	808 CHH	<-	Timpani F#
43	Low Tom1	Room Low	Room Low	Elec Low Tom1	808 Low Tom1	<-	Timpani G
44	Pedal Hi-hat	<-	<-	<-	808 CHH	<-	Timpani G#
45	Mid Tom2	Room Mid Tom2	Room Mid Tom2	Elec Mid Tom2	808 Mid Tom2	<-	Timpani A
46	Open Hi-hat	<-	<-	<-	808 OHH	<-	Timpani A#
47	Mid Tom1	Room Mid Tom1	Room Mid Tom1	Elec Mid Tom1	808 Mid Tom1	<-	Timpani B
C48	High Tom2	Room Hi Tom2	Room Hi Tom2	Elec Hi Tom2	808 Hi Tom2	<-	Timpani c
49	Crash Cymbal1	<-	<-	<-	808 Cymbal	<-	Timpani c#
50	High Tom1	Room Hi Tom1	Room Hi Tom1	Elec Hi Tom1	808 Hi Tom1	<-	Timpani d
51	Ride Cymbal1	<-	<-	<-	<-	<-	Timpani d#
52	Chinese Cymbal	<-	<-	Reverse Cymbal	<-	<-	Timpani e
53	Ride Bell	<-	<-	<-	<-	<-	Timpani f
54	Tambourine	<-	<-	<-	<-	<-	<-
55	Splash Cymbal	<-	<-	<-	<-	<-	<-
56	Cowbell	<-	<-	<-	808 Cowbell	<-	<-
57	Crash Cymbal2	<-	<-	<-	<-	<-	Concert
58	Vibra-slap	<-	<-	<-	<-	<-	<-
59	Ride Cymbal2	<-	<-	<-	<-	<-	Concert
C60	High Bongo	<-	<-	<-	<-	<-	<-
61	Low Bongo	<-	<-	<-	<-	<-	<-
62	Mute High Conga	<-	<-	<-	808 High Conga	<-	<-
63	Open High Conga	<-	<-	<-	808 Mid Conga	<-	<-
64	Low Conga	<-	<-	<-	808 Low Conga	<-	<-
65	High Timbale	<-	<-	<-	<-	<-	<-
66	Low Timbale	<-	<-	<-	<-	<-	<-
67	High Agogo	<-	<-	<-	<-	<-	<-
68	Low Agogo	<-	<-	<-	<-	<-	<-
69	Cabasa	<-	<-	<-	<-	<-	<-
70	Maracas	<-	<-	<-	808 Maracas	<-	<-
71	Short Hi Whistle	<-	<-	<-	<-	<-	<-
C72	Long Low Whistle	<-	<-	<-	<-	<-	<-
73	Short Guiro	<-	<-	<-	<-	<-	<-
74	Long Guiro	<-	<-	<-	<-	<-	<-
75	Claves	<-	<-	<-	808 Claves	<-	<-
76	High Wood Block	<-	<-	<-	<-	<-	<-
77	Low Wood Block	<-	<-	<-	<-	<-	<-
78	Mute Cuica	<-	<-	<-	<-	<-	<-
79	Open Cuica	<-	<-	<-	<-	<-	<-
80	Mute Triangle	<-	<-	<-	<-	<-	<-
81	Open Triangle	<-	<-	<-	<-	<-	<-
82	Shaker	<-	<-	<-	<-	<-	<-
83	Jingle Bell	<-	<-	<-	<-	<-	<-
C84	Bell Tree	<-	<-	<-	<-	<-	<-
85	Castanets	<-	<-	<-	<-	<-	<-
86	Mute Surdo	<-	<-	<-	<-	<-	<-
87	Open Surdo	<-	<-	<-	<-	<-	<-
88	----	----	----	----	----	----	Applause

■ GS mode drum set (2)

		PC 57
		SFX
	35	----
C2	36	----
	37	----
	38	----
	39	High Q
	40	Slap
	41	Scratch Push
	42	Scratch Pull
	43	Sticks
	44	Square Click
	45	Metronome Click
	46	Metronome Bell
	47	Guitar Fret Noise
C3	48	Guitar cutting
	49	Guitar cutting
	50	String slap of double
	51	Fl.Key Click
	52	Laughing
	53	Scream
	54	Punch
	55	Heart Beat
	56	Footsteps1
	57	Footsteps2
	58	Applause
	59	Door Creaking
C4	60	Door
	61	Scratch
	62	Wind Chimes
	63	Car-Engine
	64	Car-Stop
	65	Car-Pass
	66	Car-Crash
	67	Siren
	68	Train
	69	Jetplane
	70	Helicopter
	71	Starship
C5	72	Gun Shot
	73	Machine Gun
	74	Lasergun
	75	Explosion
	76	Dog
	77	Horse-Gallop
	78	Birds
	79	Rain
	80	Thunder
	81	Wind
	82	Seashore
	83	Stream
C6	84	Bubble
	85	----
	86	----
	87	----
	88	----
	89	----
	90	----
	91	----
	92	----
	93	----
	94	----
	95	----

Drum set list (XGLite mode)

* The instrument names listed here are the proper names for the XGLite sound module mode. Due to the limited number of letters that can be used for the display, the names shown in the display may be slightly different from the instrument names listed here.

PC	MSB	LSB	XG Set	MSB	LSB	XG Set
001	127	0	Standard Kit	126	0	SFX Kit 1
002	127	0	Standard Kit 2	126	0	SFX Kit 2
009	127	0	Room Kit			
017	127	0	Rock Kit			
025	127	0	Electro Kit			
026	127	0	Analog Kit			
033	127	0	Jazz Kit			
041	127	0	Brush Kit			
049	127	0	Classic Kit			

■ XGlite mode drum set (1)

* BANK MSB=127, LSB=0

	PC001	PC002	PC009	PC017	PC025
	Standard Kit	Standard Kit 2	Room Kit	Rock Kit	Electro Kit
C012	13 Surdo Mute	<-	<-	<-	<-
14	Surdo Open	<-	<-	<-	<-
15	Hi Q	<-	<-	<-	<-
16	Whip Slap	<-	<-	<-	<-
17	Scratch H	<-	<-	<-	<-
18	Scratch L	<-	<-	<-	<-
19	Finger Snap	<-	<-	<-	<-
20	Click Noise	<-	<-	<-	<-
21	Metronome Click	<-	<-	<-	<-
22	Metronome Bell	<-	<-	<-	<-
23	Seq Click L	<-	<-	<-	<-
C124	Seq Click H	<-	<-	<-	<-
25	Brush Tap	<-	<-	<-	<-
26	Brush Swirl	<-	<-	<-	<-
27	Brush Slap	<-	<-	<-	<-
28	Brush Tap Swirl	<-	<-	<-	Reverse Cymbal
29	Snare Roll	Snare Roll 2	<-	<-	<-
30	Castanet	<-	<-	<-	Hi Q 2
31	Snare Soft	Snare Soft 2	<-	Snare Noisy	Snare Snappy Elec-
32	Sticks	<-	<-	<-	<-
33	Kick Soft	<-	<-	Kick Tight 2	Kick 3
34	Open Rim Shot	Open Rim Shot H	<-	<-	<-
35	Kick Tight	Kick Tight Short	<-	Kick 2	Kick Gate
C236	Kick	Kick Short	<-	Kick Gate	Kick Gate Heavy
37	Side Stick	<-	<-	<-	<-
38	Snare	Snare Short	Snare Snappy	Snare Rock	Snare Noisy 2
39	Hand Clap	<-	<-	<-	<-
40	Snare Tight	Snare Tight H	Snare Tight Snappy	Snare Rock Rim	Snare Noisy 3
41	Floor Tom L	<-	Tom Room 1	Tom Rock 1	Tom Electro 1
42	Hi-Hat Closed	<-	<-	<-	<-
43	Floor Tom H	<-	Tom Room 2	Tom Rock 2	Tom Electro 2
44	Hi-Hat Pedal	<-	<-	<-	<-
45	Low Tom	<-	Tom Room 3	Tom Rock 3	Tom Electro 3
46	Hi-Hat Open	<-	<-	<-	<-
47	Mid Tom L	<-	Tom Room 4	Tom Rock 4	Tom Electro 4
C348	Mid Tom H	<-	Tom Room 5	Tom Rock 5	Tom Electro 5
49	Crash Cymbal 1	<-	<-	<-	<-
50	High Tom	<-	Tom Room 6	Tom Rock 6	Tom Electro 6
51	Ride Cymbal 1	<-	<-	<-	<-
52	Chinese Cymbal	<-	<-	<-	<-
53	Ride Cymbal Cup	<-	<-	<-	<-
54	Tambourine	<-	<-	<-	<-
55	Splash Cymbal	<-	<-	<-	<-
56	Cowbell	<-	<-	<-	<-
57	Crash Cymbal 2	<-	<-	<-	<-
58	Vibraslap	<-	<-	<-	<-
59	Ride Cymbal 2	<-	<-	<-	<-
C460	Bongo H	<-	<-	<-	<-
61	Bongo L	<-	<-	<-	<-
62	Conga H Mute	<-	<-	<-	<-
63	Conga H Open	<-	<-	<-	<-
64	Conga L	<-	<-	<-	<-
65	Timbale H	<-	<-	<-	<-
66	Timbale L	<-	<-	<-	<-
67	Agogo H	<-	<-	<-	<-
68	Agogo L	<-	<-	<-	<-
69	Cabasa	<-	<-	<-	<-
70	Maracas	<-	<-	<-	<-
71	Samba Whistle H	<-	<-	<-	<-

	PC001 Standard Kit	PC002 Standard Kit 2	PC009 Room Kit	PC017 Rock Kit	PC025 Electro Kit
C5 72	Samba Whistle L	<-	<-	<-	<-
73	Guiro Short	<-	<-	<-	<-
74	Guiro Long	<-	<-	<-	<-
75	Claves	<-	<-	<-	<-
76	Wood Block H	<-	<-	<-	<-
77	Wood Block L	<-	<-	<-	<-
78	Cuica Mute	<-	<-	<-	Scratch H 2
79	Cuica Open	<-	<-	<-	Scratch L 2
80	Triangle Mute	<-	<-	<-	<-
81	Triangle Open	<-	<-	<-	<-
82	Shaker	<-	<-	<-	<-
83	Jingle Bells	<-	<-	<-	<-
C6 84	Bell Tree	<-	<-	<-	<-

■ XGlite mode drum set (2)

* BANK MSB=127, LSB=0

	PC001 Standard Kit	PC026 Analog Kit	PC033 Jazz Kit	PC041 Brush Kit	PC049 Classic Kit
C0 12	Surdo Mute	<-	<-	<-	<-
13	Surdo Open	<-	<-	<-	<-
14	Hi Q	<-	<-	<-	<-
15	Whip Slap	<-	<-	<-	<-
16	Scratch H	<-	<-	<-	<-
17	Scratch L	<-	<-	<-	<-
18	Finger Snap	<-	<-	<-	<-
19	Click Noise	<-	<-	<-	<-
20	Metronome Click	<-	<-	<-	<-
21	Metronome Bell	<-	<-	<-	<-
22	Seq Click L	<-	<-	<-	<-
23	Seq Click H	<-	<-	<-	<-
C1 24	Brush Tap	<-	<-	<-	<-
25	Brush Swirl	<-	<-	<-	<-
26	Brush Slap	<-	<-	<-	<-
27	Brush Tap Swirl	Reverse Cymbal	<-	<-	<-
28	Snare Roll	<-	<-	<-	<-
29	Castanet	Hi Q 2	<-	<-	<-
30	Snare Soft	Snare Noisy 4	<-	Brush Slap 2	<-
31	Sticks	<-	<-	<-	<-
32	Kick Soft	Kick Tight 2	<-	<-	Kick Soft 2
33	Open Rim Shot	<-	<-	<-	<-
34	Kick Tight	Kick Analog Short	<-	<-	Gran Cassa
35	Kick	Kick Analog	Kick Jazz	Kick Small	Gran Cassa Mute
C2 36	Side Stick	Side Stick Analog	<-	<-	<-
37	Snare	Snare Analog	<-	Brush Slap 3	Band Snare
38	Hand Clap	<-	<-	<-	<-
39	Snare Tight	Snare Analog 2	<-	Brush Tap 2	Band Snare 2
40	Floor Tom L	Tom Analog 1	Tom Jazz 1	Tom Brush 1	Tom Jazz 1
41	Hi-Hat Closed	Hi-Hat Closed Ana-	<-	<-	<-
42	Floor Tom H	Tom Analog 2	Tom Jazz 2	Tom Brush 2	Tom Jazz 2
43	Hi-Hat Pedal	Hi-Hat Closed Ana-	<-	<-	<-
44	Low Tom	Tom Analog 3	Tom Jazz 3	Tom Brush 3	Tom Jazz 3
45	Hi-Hat Open	Hi-Hat Open Analog	<-	<-	<-
46	Mid Tom L	Tom Analog 4	Tom Jazz 4	Tom Brush 4	Tom Jazz 4
47	Mid Tom H	Tom Analog 5	Tom Jazz 5	Tom Brush 5	Tom Jazz 5
C3 48	Crash Cymbal 1	Crash Analog	<-	<-	Hand Cymbal
49	High Tom	Tom Analog 6	Tom Jazz 6	Tom Brush 6	Tom Jazz 6
50	Ride Cymbal 1	<-	<-	<-	Hand Cymbal Short
51	Chinese Cymbal	<-	<-	<-	<-
52					

	PC001 Standard Kit	PC026 Analog Kit	PC033 Jazz Kit	PC041 Brush Kit	PC049 Classic Kit
53	Ride Cymbal Cup	<-	<-	<-	<-
54	Tambourine	<-	<-	<-	<-
55	Splash Cymbal	<-	<-	<-	<-
56	Cowbell	Cowbell Analog	<-	<-	<-
57	Crash Cymbal 2	<-	<-	<-	Hand Cymbal 2
58	VibraSlap	<-	<-	<-	<-
59	Ride Cymbal 2	<-	<-	<-	Hand Cymbal 2 Short
C4 60	Bongo H	<-	<-	<-	<-
61	Bongo L	<-	<-	<-	<-
62	Conga H Mute	Conga Analog H	<-	<-	<-
63	Conga H Open	Conga Analog M	<-	<-	<-
64	Conga L	Conga Analog L	<-	<-	<-
65	Timbale H	<-	<-	<-	<-
66	Timbale L	<-	<-	<-	<-
67	Agogo H	<-	<-	<-	<-
68	Agogo L	<-	<-	<-	<-
69	Cabasa	<-	<-	<-	<-
70	Maracas	Maracas 2	<-	<-	<-
71	Samba Whistle H	<-	<-	<-	<-
C5 72	Samba Whistle L	<-	<-	<-	<-
73	Guiro Short	<-	<-	<-	<-
74	Guiro Long	<-	<-	<-	<-
75	Claves	Claves 2	<-	<-	<-
76	Wood Block H	<-	<-	<-	<-
77	Wood Block L	<-	<-	<-	<-
78	Cuica Mute	Scratch H 2	<-	<-	<-
79	Cuica Open	Scratch L 3	<-	<-	<-
80	Triangle Mute	<-	<-	<-	<-
81	Triangle Open	<-	<-	<-	<-
82	Shaker	<-	<-	<-	<-
83	Jingle Bells	<-	<-	<-	<-
C6 84	Bell Tree	<-	<-	<-	<-

■ XGlite mode drum set (3)

* BANK MSB=126, LSB=0

	PC001	PC002
	SFX Kit 1	SFX Kit 2
C2 36	Cutting Noise	---
37	Cutting Noise 2	Door Squeak
38	---	Door Slam
39	String Slap	Scratch Cut
40	---	Scratch H 3
41	---	Wind Chime
42	---	Telephone Ring 2
43	---	---
44	---	---
45	---	---
46	---	---
47	---	---
C3 48	---	---
49	---	---
50	---	---
51	---	---
52	Flute Key Click	Car Engine Igni-
53	---	Car Tires Squeal
54	---	Car Passing
55	---	Car Crash
56	---	Siren
57	---	Train
58	---	Jet Plane
59	---	Starship
C4 60	---	Burst
61	---	Roller Coaster
62	---	Submarine
63	---	---
64	---	---
65	---	---
66	---	---
67	---	---
68	Shower	Laugh
69	Thunder	Scream
70	Wind	Punch
71	Stream	Heart Beat
C5 72	Bubble	Foot Steps
73	---	---
74	---	---
75	---	---
76	---	---
77	---	---
78	---	---
79	---	---
80	---	---
81	---	---
82	---	---
83	---	---
C6 84	Dog	Machine Gun
85	Horse	Laser Gun
86	Bird Tweet 2	Explosion
87	---	Firework
88	---	---
89	---	---
90	Ghost	---

Specifications

■ Model: Studio Canvas SD-20 (General MIDI2 / GS format / XGlite format)

●Number of parts

32

●Maximum Polyphony

64 voices

●Internal Sounds

Sound Maps: 3 (Classical, Contemporary, Solo)

Internal Sounds: 660

Drum Sound sets: 23

●Effects

System Effects: Reverb (6 types)

Chorus (6 types)

●Display

Power indicator

USB indicator

OUTPUT Level indicator

Mode indicator

●Connectors

MIDI connector (IN)

USB connector

Serial connector

Digital Audio OUT connector

OPTICAL type (conforms to S/P DIF)

Audio Input jack (stereo miniature phone type)

Audio Output jacks L, R (RCA phono type)

Headphones jack (stereo mini)

●Power Supply

DC 9 V (AC adaptor)

●Current Draw

500 mA

●Dimensions

203 (W) x 159 (D) x 35 (H) mm

8 (W) x 6-5/16 (D) x 1-7/16 (H) inches

●Weight

0.4 kg

15 oz

●Accessories

USB cable

Conversion cable

(stereo miniature phone type <-> RCA phono type)

AC adaptor

Owner's Manual

CD-ROM

●Options

Computer cable

- RS-232C

- RS-422

* 0 dBu = 0.775 V rms

* In the interest of product improvement, the specifications and/or appearance of this unit are subject to change without prior notice.

*

Computer Cable Wiring Diagrams

For PC (9-pin) (Sold separately: RS-232C)

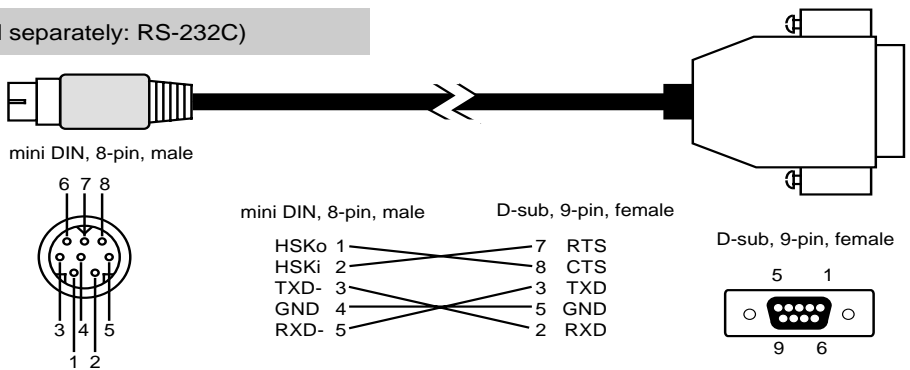

For Apple Macintosh (Sold separately: RS-422)

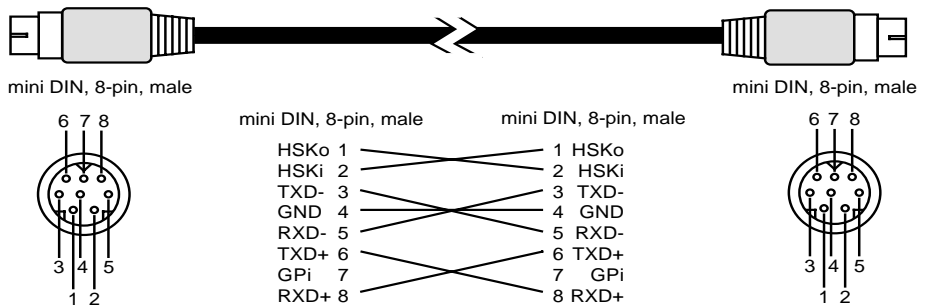

Information

When you need repair service, call your nearest EDIROL/Roland Service Center or authorized EDIROL/Roland distributor in your country as shown below.

EDIROL

EUROPE

EDIROL (Europe) Ltd.
Studio 3.4 114 Power Road
London W4 5PY
U. K.
TEL: +44 (0)20 8747 5949
FAX:+44 (0)20 8747 5948
http://www.edirol.com/europe

Deutschland
TEL: 0700 33 47 65 20

France
TEL: 0810 000 371

Italia
TEL: 02 93778329

Roland

NORTH AMERICA

CANADA

Roland Canada Music Ltd.
(Head Office)
5480 Parkwood Way Richmond
B. C., V6V 2M4 CANADA
TEL: (604) 270 6626

Roland Canada Music Ltd.
(Toronto Office)
170 Admiral Boulevard
Mississauga On L5T 2N6
CANADA
TEL: (905) 362 9707

U. S. A.

Roland Corporation U.S.
5100 S. Eastern Avenue
Los Angeles, CA 90040-2938,
U. S. A.
TEL: (323) 890 3700

AFRICA

EGYPT

Al Fanny Trading Office
9, EBN Hagar Al Askalany
Street,
ARD El Golf, Heliopolis,
Cairo 11341, EGYPT
TEL: 20-2-417-1828

REUNION

Maison FO - YAM Marcel
25 Rue Jules Hermann,
Chaudron - BP79 97 491
Ste Clotilde Cedex,
REUNION ISLAND
TEL: (0262) 218-429

SOUTH AFRICA

Paul Bothner(PTY)Ltd.
Royal Cape Park, Unit 24
Londonderry Road, Ottery 7800
Cape Town, SOUTH AFRICA
TEL: (021) 799 4900

ASIA

CHINA

Roland Shanghai Electronics Co.,Ltd.
5F. No.1500 Pingliang Road
Shanghai 200090, CHINA
TEL: (021) 5580-0800

Roland Shanghai Electronics Co.,Ltd.

(BEIJING OFFICE)
10F. No.18 3 Section Anhuaxili
Chaoyang District Beijing
100011 CHINA
TEL: (010) 6426-5050

Roland Shanghai Electronics Co.,Ltd.
(GUANGZHOU OFFICE)
2/F., No.30 Si You Nan Er Jie
Yi Xiang, Wu Yang Xin Cheng,
Guangzhou 510600, CHINA
TEL: (020) 8736-0428

HONG KONG

Parsons Music Ltd.
8th Floor, Railway Plaza, 39
Chatham Road South, T.S.T,
Kowloon, HONG KONG
TEL: 2333 1863

INDIA

Rivera Digitec (India) Pvt. Ltd.
409, Nirmam Kendra
Mahalaxmi Flats Compound
Off. Dr. Edwin Moses Road,
Mumbai-400011, INDIA
TEL: (022) 2493 9051

INDONESIA

PT Citra IntiRama
Jl. Cideng Timur No. 15J-150
Jakarta Pusat
INDONESIA
TEL: (021) 6324170

KOREA

Cosmos Corporation
1461-9, Seocho-Dong,
Seocho Ku, Seoul, KOREA
TEL: (02) 3486-8855

MALAYSIA/ SINGAPORE

Roland Asia Pacific Sdn. Bhd.
45-1, Block C2, Jalan PJU 1/39,
Dataran Prima, 47301 Petaling
Jaya, Selangor, MALAYSIA
TEL: (03) 7805-3263

PHILIPPINES

G.A. Yupangco & Co. Inc.
339 Gil J. Puyat Avenue
Makati, Metro Manila 1200,
PHILIPPINES
TEL: (02) 899 9801

TAIWAN

**ROLAND TAIWAN
ENTERPRISE CO., LTD.**
Room 5, 9fl. No. 112 Chung
Shan N.Road Sec.2, Taipei,
TAIWAN, R.O.C.
TEL: (02) 2561 3339

THAILAND

Theera Music Co., Ltd.
330 Soi Verng NakornKasem,
New Road, Sumpantawongse,
Bangkok 10100, THAILAND
TEL: (02) 224-8821

VIETNAM

**SAIGON MUSIC
DISTRIBUTOR
(TAN DINH MUSIC)**
138 Tran Quang Khai Street
Dist. 1, Ho Chi Minh City
VIETNAM
TEL: (08) 848-4068

AUSTRALIA/ NEW ZEALAND

AUSTRALIA/ NEW ZEALAND

**Roland Corporation
Australia Pty.,Ltd.**
38 Campbell Avenue
Dee Why West. NSW 2099
AUSTRALIA

For Australia
Tel: (02) 9982 8266
For New Zealand
Tel: (09) 3098 715

CENTRAL/LATIN AMERICA

ARGENTINA

Instrumentos Musicales S.A.
Av.Santa Fe 2055
(1123) Buenos Aires
ARGENTINA
TEL: (011) 4508-2700

BARBADOS

A&B Music Supplies LTD
12 Webster Industrial Park
Wildley, St.Michael, Barbados
TEL: (246)430-1100

BRAZIL

Roland Brasil Ltda.
Rua San Jose, 780 Sala B
Parque Industrial San Jose
Cotia - Sao Paulo - SP, BRAZIL
TEL: (011) 4615 5666

CHILE

Comercial Fancy II S.A.
Rut.: 96.919.420-1
Natanuel Cox #739, 4th Floor
Santiago - Centro, CHILE
TEL: (02) 688-9540

COLOMBIA

Centro Musical Ltda.
Cra 43 B No 25 A 41 Bodeoga 9
Medellin, Colombia
TEL: (574)3812529

CURACAO

Zeelandia Music Center Inc.
Orionweg 30
Curacao, Netherland Antilles
TEL:(305)5926866

DOMINICAN REPUBLIC

Instrumentos Fernando Giraldez
Calle Proyecto Central No.3
Ens.La Esperilla
Santo Domingo,
Dominican Republic
TEL:(809) 683 0305

ECUADOR

Mas Musica
Rumichaca 822 y Zaruma
Guayaquil - Ecuador
TEL:(593-4)2302364

GUATEMALA

Casa Instrumental
Calzada Roosevelt 34-01,zona 11
Ciudad de Guatemala
Guatemala
TEL:(502) 599-2888

HONDURAS

Almacen Pajaro Azul S.A. de C.V.
BO.Paz Barahona
3 Ave.11 Calle S.O
San Pedro Sula, Honduras
TEL: (504) 553-2029

MARTINIQUE

Musique & Son
Z.I.Les Mangle
97232 Le Lamantin
Martinique F.W.I.
TEL: 596 596 426860

Gigamusik SARI
10 Rte De La Folie
97200 Fort De France
Martinique F.W.I.
TEL: 596 596 715222

MEXICO

Casa Veerkamp, s.a. de c.v.
Av. Toluca No. 323, Col. Olivar
de los Padres 01780 Mexico
D.F. MEXICO
TEL: (55) 5668-6699

NICARAGUA

**Bansbach Instrumentos
Musicales Nicaragua**
Altamira D'Este Calle Principal
de la Farmacia 5ta.Avenida
1 Cuadra al Lago.#503
Managua, Nicaragua
TEL: (505)277-2557

PERU

Audionet
Distribuciones Musicales SAC
Juan Fanning 530
Miraflores
Lima - Peru
TEL: (511) 4461388

TRINIDAD

AMR Ltd
Ground Floor
Maritime Plaza
Barataria Trinidad W.I.
TEL: (868)638 6385

URUGUAY

Todo Musica S.A.
Francisco Acuna de Figueroa 1771
C.P.: 11.800
Montevideo, URUGUAY
TEL: (02) 924-2335

VENEZUELA

**Instrumentos Musicales
Allegro,C.A.**
Av.las industrias edf.Guitar
import
#7 zona Industrial de Turumo
Caracas, Venezuela
TEL: (212) 244-1122

EUROPE

AUSTRIA

**Roland Elektronische
Musikinstrumente HmbH.
Austrian Office**
Eduard-Bodem-Gasse 8,
A-6020 Innsbruck, AUSTRIA
TEL: (0512) 26 44 260

BELGIUM/FRANCE/ HOLLAND/ LUXEMBOURG

Roland Central Europe N.V.
Houtstraat 3, B-2260, Oevel
(Westerlo) BELGIUM
TEL: (014) 575811

CZECH REP.

K-AUDIO
Kardasovska 626.
CZ-198 00 Praha 9,
CZECH REP.
TEL: (2) 666 10529

DENMARK

Roland Scandinavia A/S
Nordhavnsvej 7, Postbox 880,
DK-2100 Copenhagen
DENMARK
TEL: 3916 2000

FINLAND

**Roland Scandinavia As, Filial
Finland**
Elannontie 5
FIN-01510 Vantaa, FINLAND
TEL: (09) 68 24 020

GERMANY

**Roland Elektronische
Musikinstrumente HmbH.**
Oststrasse 96, 22844
Norderstedt, GERMANY
TEL: (040) 52 60090

GREECE

STOLLAS S.A.
Music Sound Light
155, New National Road
Patras 26442, GREECE
TEL: 2610 435400

HUNGARY

Roland East Europe Ltd.
Warehouse Area 'DEPO' Pf.83
H-2046 Torokbalint,
HUNGARY
TEL: (23) 511011

IRELAND

Roland Ireland
G2 Calmount Park, Calmount
Avenue, Dublin 12
Republic of IRELAND
TEL: (01) 4294444

ITALY

Roland Italy S. p. A.
Viale delle Industrie 8,
20020 Arese, Milano, ITALY
TEL: (02) 937-78300

NORWAY

**Roland Scandinavia Avd.
Kontor Norge**
Lilleakerveien 2 Postboks 95
Lilleaker N-0216 Oslo
NORWAY
TEL: 2273 0074

POLAND

MX MUSIC SP.Z.O.O.
UL. Gibraltarska 4.
PL-03664 Warszawa POLAND
TEL: (022) 679 44 19

PORTUGAL

Roland Iberia, S.L.
Portugal Office
Cais das Pedras, 8/9-1 Dto
4050-465, Porto, PORTUGAL
TEL: 22 608 00 60

ROMANIA

FBS LINES
Piata Libertatii 1,
535500 Gheorgheni,
ROMANIA
TEL: (266) 364 609

RUSSIA

MuTek
Dorozhnaya ul.3,korp.6
117 545 Moscow, RUSSIA
TEL: (095) 981-4967

SPAIN

Roland Iberia, S.L.
Paseo Garcia Faria, 33-35
08005 Barcelona SPAIN
TEL: 93 493 91 00

SWEDEN

Roland Scandinavia A/S
SWEDISH SALES OFFICE
Danvik Center 28, 2 tr.
S-131 30 Nacka SWEDEN
TEL: (08) 702 00 20

SWITZERLAND

Roland (Switzerland) AG
Landstrasse 5, Postfach,
CH-4452 Itingen,
SWITZERLAND
TEL: (061) 927-8383

UKRAINE

TIC-TAC
Mira Str. 19/108
P.O. Box 180
295400 Munkachevo,
UKRAINE
TEL: (03131) 414-40

UNITED KINGDOM

Roland (U.K.) Ltd.
Atlantic Close, Swansea
Enterprise Park, SWANSEA
SA7 9FJ,
UNITED KINGDOM
TEL: (01792) 702701

MIDDLE EAST

BAHRAIN

Moon Stores
No.16, Bab Al Bahrain Avenue,
P.O.Box 247, Manama 304,
State of BAHRAIN
TEL: 17 211 005

CYPRUS

Radex Sound Equipment Ltd.
17, Diagorou Street, Nicosia,
CYPRUS
TEL: (022) 66-9426

IRAN

MOCO INC.
No.41 Nike St., Dr.Shariyati Ave.,
Roberoye Cerah Mirdamad
Teheran, IRAN
TEL: (021) 285-4169

ISRAEL

**Halilit P. Greenspoon & Sons
Ltd.**
8 Retzif Ha'aliya Hashnya St.
Tel-Aviv-Yafo ISRAEL
TEL: (03) 6823666

JORDAN

**MUSIC HOUSE CO. LTD.
FREDDY FOR MUSIC**
P. O. Box 922846
Amman 11192 JORDAN
TEL: (06) 5692696

KUWAIT

**EASA HUSAIN AL-YOUSIFI
& SONS CO.**
Abdullah Salem Street,
Safat, KUWAIT
TEL: 243-6399

LEBANON

Chahine S.A.L.
Gerge Zeidan St., Chahine
Malatan House No.1
Al Noor Street, Ruwi
SULTANATE OF OMAN
TEL: 2478 3443

OMAN

TALENTZ CENTRE L.L.C.
Malatan House No.1
Al Noor Street, Ruwi
SULTANATE OF OMAN
TEL: 2478 3443

QATAR

Badie Studio & Stores
P.O. Box 62,
Doha, QATAR
TEL: 423554

SAUDI ARABIA

**aDawlah Universal
Electronics APL**
Corniche Road, Aldossary
Bldg., 1st Floor, Alkhorbar,
SAUDI ARABIA

**P.O.Box 2154, Alkhorbar 31952
SAUDI ARABIA
TEL: (03) 898 2081**

SYRIA

**Technical Light & Sound
Center**
Rawda, Abdul Qader Jazairi St.
Bldg. No. 21, P.O.BOX 13520,
Damascus, SYRIA
TEL: (011) 223-5384

TURKEY

ZUHAL DIS TICARET A.S.
Galip Dede Cad. No.37
Beyoglu - Istanbul / TURKEY
TEL: (0212) 249 85 10

U.A.E.

**Zak Electronics & Musical
Instruments Co. L.L.C.**
Zabeel Road, Al Sherooq Bldg.,
No. 14, Grand Floor, Dubai,
U.A.E.
TEL: (04) 3360715