



SP-404MK2 (Version 3.00)

Reference Manual

Table of contents

Introduction	4	Marking and Splitting Samples (MARK)	46
What You Should Know About This Unit (How Data is Organized)	4	Using a Marker to Split and Assign a Sample to a Pad (CHOP)	48
What's a Sample?	4	Making Fade-in/Fade-out Settings (ENVELOPE)	49
What's a Pattern?	4	Changing the Pitch or Playback Speed of a Sample (PITCH/SPEED)	52
Banks and Projects	5	Displaying Parameters Set in a Sample	54
Getting Things Ready	6	Initializing the Sample Parameters (INIT PARAM)	55
Connecting External Equipment	6	Organizing the Samples	56
About the Power Supply	8	Exchanging (Swapping) Samples Between Pads	56
Turning the Power On/Off	10	Copying the Sample from a Pad	56
Playing Back Samples (SAMPLE MODE)	12	Copying all samples in a bank to another bank	57
Selecting a Sample Bank	12	Protecting a Sample (PROTECT)	57
Adjusting the Volume for All Banks (BANK VOLUME)	13	Deleting the Sample from a Pad	57
Playing Back a Sample to the Tempo of a Song (BPM SYNC)	14	Combining Samples to Create a Pattern (PATTERN SEQUENCER)	59
Playing Back Only While a Pad is Pressed (GATE)	15	Playing a Pattern	59
Playing Back Samples Only One Time (One-shot Playback)	16	Creating a New Pattern (Real-time Recording)	60
Playing Back Samples Repeatedly (LOOP)	17	Adding a Count-in Before Recording a Pattern	61
Playing Back a Sample in Reverse (REVERSE)	18	Creating a New Pattern (TR-REC)	62
Playing Back Samples in Detailed Steps (ROLL)	19	Converting Patterns to Samples	65
Setting the Roll Interval	19	Sampling a Pattern (RESAMPLE)	65
Setting a Fixed Sample Volume (FIXED VELOCITY)	21	Converting Patterns to Samples (BOUNCE)	66
Changing the Sample Volume for Playback (16 VELOCITY)	22	Selecting a Pattern Bank	67
Playing Back Samples in Scale Pitches (CHROMATIC)	23	Playing Back Patterns in Order (PATTERN CHAIN)	68
Muting the Playback of a Sample (PAD MUTE)	24	Recording Effect Operations to a Pattern (EFX MOTION REC)	71
Playing Back Multiple Pads at the Same Time (PAD LINK GROUPS)	25	Deleting Effect Operations Recorded in a Pattern (EFX MOTION ERASE)	72
Preventing Samples from Playing Back at the Same Time (MUTE GROUP)	26	Deleting Specific Effect Operations From a Pattern	72
Stopping All Sample Playback (STOP)	27	Recording Pad Mute Operations to a Pattern (PAD MUTE MOTION REC)	73
Pausing the Sound of a Sample (PAUSE)	27	Deleting Pad Mute Operations Recorded in a Pattern (PAD MUTE MOTION ERASE)	74
Disabling Buttons that Are Not Used When Playing Live (LIVE MODE)	28	Deleting Specific Pad Mute Operations from a Pattern	74
Using the Effects	29	Editing a Pattern (PATTERN EDIT)	75
Adding Effects to a Sample (BUS FX)	29	Copying and Connecting Patterns (DUPLICATE)	75
Assigning Effects to BUS 1 and BUS 2	30	Cropping Unnecessary Sections from a Pattern (CROP)	75
Deciding on Effects to Use for Each Sample	30	Aligning the Playback Timing of Samples Inputted to a Pattern (QUANTIZE)	76
Using the MFX Effects	31	Organizing the Pattern Data	78
Editing the Effects	33	Exchanging (Swapping) Patterns Between Pads	78
Turning Effects On/Off at the Desired Timing	34	Copying the Pattern of a Pad	78
Temporarily Output Only the Effect Sound (MUTE BUS) ..	35	Extracting Specific Samples (Pads) from a Pattern	79
Temporarily Output Only the Effect Sound (MUTE BUS) ..	35	Copying all patterns in a bank to another bank	79
Temporarily Output Only the Effect Sound (MUTE BUS) ..	35	Protecting a Pattern (PROTECT)	80
Temporarily Output Only the Effect Sound (MUTE BUS) ..	35	Deleting the Pattern from a Pad	80
Sampling (SAMPLING)	37	Setting the Tempo	82
Configuring the Sampling Settings (RECORD SETTING) ..	37	Setting the Tempo Data in a Sample	83
Configuring the Input Effects (INPUT FX)	37	Setting the Tempo for a Bank or Project	85
Sampling	39	Setting the Tempo in Time with the Rhythm (Tap Tempo)	86
Adding a Count-in Before Sampling	39	Setting the Tempo in Time with the Rhythm (Tap Tempo)	86
Automatically Setting the End Point of a Sample (END SNAP)	39	Mixing the Samples (DJ MODE)	87
Resampling a Sample (RESAMPLE)	41	Playing Back Samples While in DJ Mode (PAD MODE)	89
Sampling What You Previously Played (SKIP-BACK SAMPLING)	42	Playing Back Patterns While in DJ Mode	90
Editing a Sample (SAMPLE EDIT)	44	Playing Back a Sample from the Marker Position	91
Setting the Playback and Loop Regions (START/END)	44	Adding a Marker While Playing Back a Sample	92
Processing a Sample	45	Editing a Marker While Playing Back a Sample	92

Deleting All Set Markers from a Sample	93	MFX List	129
Editing a Sample in DJ Mode	94	Filter+Drive.....	129
Monitoring with Headphones (CUE).....	95	Resonator	129
Inputting Sound from an Electronic Musical Instrument, Mic or Guitar.....	96	Sync Delay.....	129
Inputting Audio from a Computer or Mobile Device (USB AUDIO).....	97	Isolator	129
Selecting a Project	98	DJFX Looper	130
Organizing Projects	99	Scatter	130
Copying a Project	99	Downer	130
Deleting a Project	100	Ha-Dou.....	130
Customizing This Unit.....	101	Ko-Da-Ma	131
Attaching/Removing the Faceplate of This Unit	101	Zan-Zou	131
Customizing the Opening Screen	103	To-Gu-Ro	131
Preparing an Opening Image	103	SBF.....	132
Saving an Opening Image to a Project.....	103	Stopper	132
Customizing the Screen Saver	104	Tape Echo.....	132
Preparing a Screen Saver Image.....	104	TimeCtrlDly.....	132
Enabling a Custom Screen Saver	104	Super Filter	133
Saving the Screen Saver Image to a Project	105	WrmSaturator	133
Configuring the Various Settings (UTILITY)	106	303 VinylSim.....	133
Editing the Settings Related to this Unit (System)	106	404 VinylSim.....	133
Configuring the Pad-related Settings (PAD SETTING)	107	Cassette Sim.....	134
Configuring the Effect Settings (EFX SET)	108	Lo-fi	134
Configuring the Effect Routing	108	Reverb	134
Adding Effects to the Overall Sound (BUS 3, BUS 4)	109	Chorus	134
Changing the Effects Assigned to BUS 3 and BUS 4	109	JUNO Chorus.....	134
Editing the Effects for BUS 3 and BUS 4.....	110	Flanger	135
Assigning the Desired Effect to an Effect Button (DIRECT FX)	111	Phaser.....	135
Configuring the Input Effects (INPUT FX)	112	Wah	135
Sending the Audio Input from the INPUT Jack to a Bus	113	Slicer.....	136
Importing/Exporting (Using the SD Card)	114	Tremolo/Pan	136
Importing Samples (IMPORT SAMPLE)	116	Chromatic PS.....	136
Exporting Samples (EXPORT SAMPLE).....	117	Hyper-Reso	136
Importing a Project (IMPORT PROJECT)	118	Ring Mod	137
Exporting a Project (EXPORT PROJECT).....	119	Crusher.....	137
Backing up Your Data (BACKUP).....	120	Overdrive.....	137
Restoring from Backup Data (RESTORE).....	120	Distortion	137
Formatting an SD Card.....	121	Equalizer.....	138
Restoring the Factory Settings (FACTORY RESET)	122	Compressor	138
Appendix.....	123	SX Reverb	138
Parameter Guide	123	SX Delay	138
SYSTEM.....	123	Cloud Delay	138
PAD SET	126	Back Spin	139
EFX SET	127	Auto Pitch	139
		Vocoder.....	139
		Harmony.....	140
		Gt Amp Sim	140
		Control change messages and corresponding effects..	140
		List of Shortcut Keys	143
		Error Messages	146
		Audio Diagram	147
		Main Specifications	148
		MIDI Implementation Chart	149
		MIDI Note Map	151

Introduction

The SP-404MK2 lets you do everything from audio sampling to editing, creating your own songs and performing... all in one unit.

MEMO

This Reference Manual assumes that your unit is using software version 3.00 or later.

What You Should Know About This Unit (How Data is Organized)

The SP-404MK2 handles a large amount of data, including audio materials and data used to create songs. In this section, we explain the role of each type of data and the structure used to manage data on the SP-404MK2.

What's a Sample?

A sample is a collection of audio that has been sampled (recorded audio data) and settings such as loop settings and routings to BUS FX (effects).

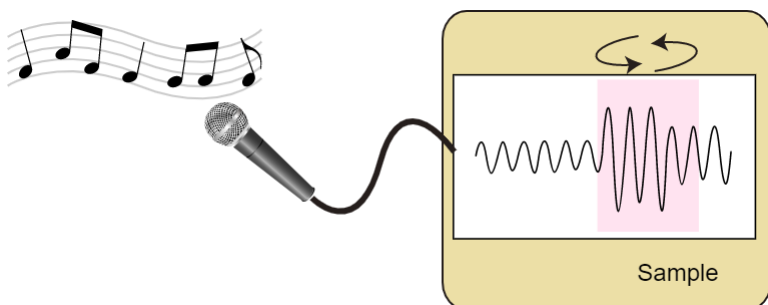

Samples can be assigned to pads [1]–[16] and played back, or you can use them as parts of patterns to construct your song.

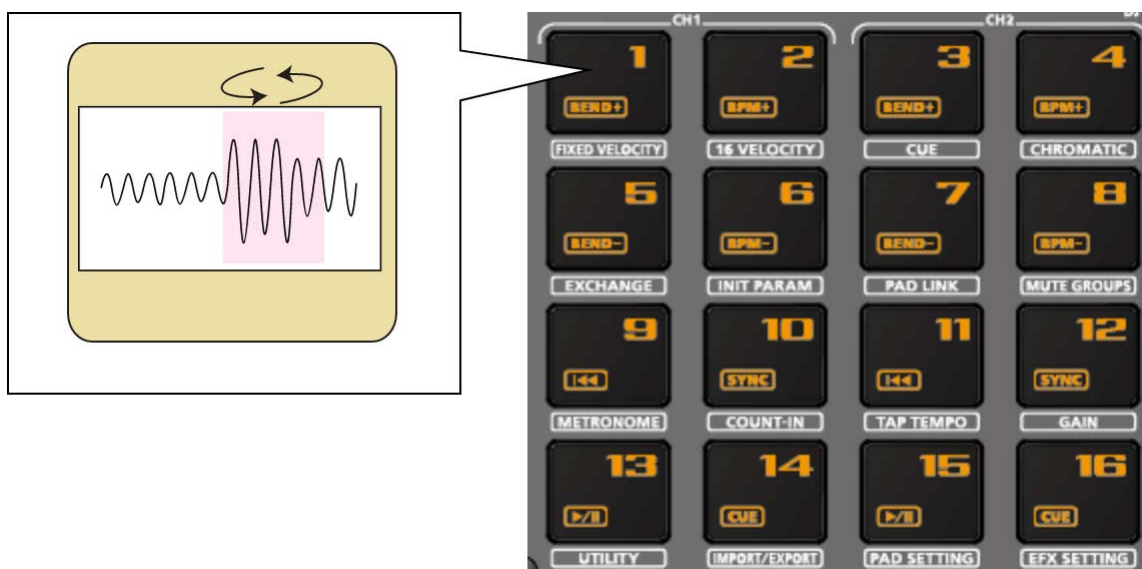

MEMO

A collection of 16 samples is called a "bank", and you can store up to 10 banks (A–J).

What's a Pattern?

A pattern is a set of data that contains the order in which the samples should be played back.

You can create a song by pressing the pads to play back several samples and then recording your performance as a pattern.

Use the pattern sequencer to record patterns.

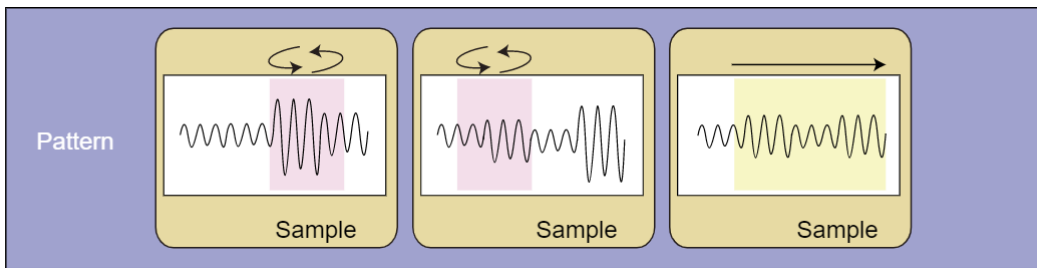

MEMO

A collection of 16 patterns is called a "bank", and you can store up to 10 banks (A-J).

Banks and Projects

The 10 banks of samples and 10 banks of patterns are collectively managed as a "project".

The SP-404MK2 can store 16 different projects.

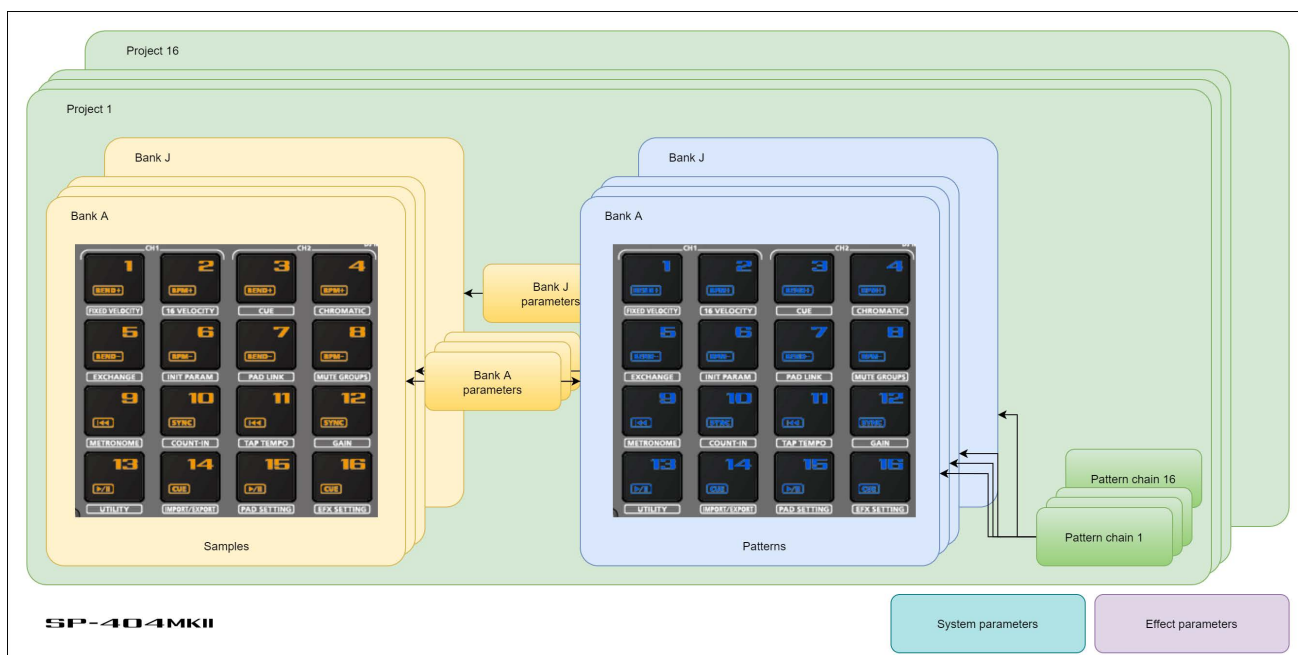

Getting Things Ready

Now, let's get ready to use the SP-404MK2. This section explains how to prepare and connect to external equipment for outputting sound, as well as the different ways to power this unit.

Connecting External Equipment

NOTE

To prevent malfunction and equipment failure, always turn down the volume, and turn off all the units before making any connections.

1. **Connect your amp or speakers to the LINE OUT jacks on the rear panel.**



2. **Use the PHONES jack when connecting headphones or earphones.**

Connect an electronic musical instrument (such as a synthesizer) to the LINE IN jack(s) on the rear panel.

3. **Connect your mic or guitar to the INPUT jack on the front panel.**

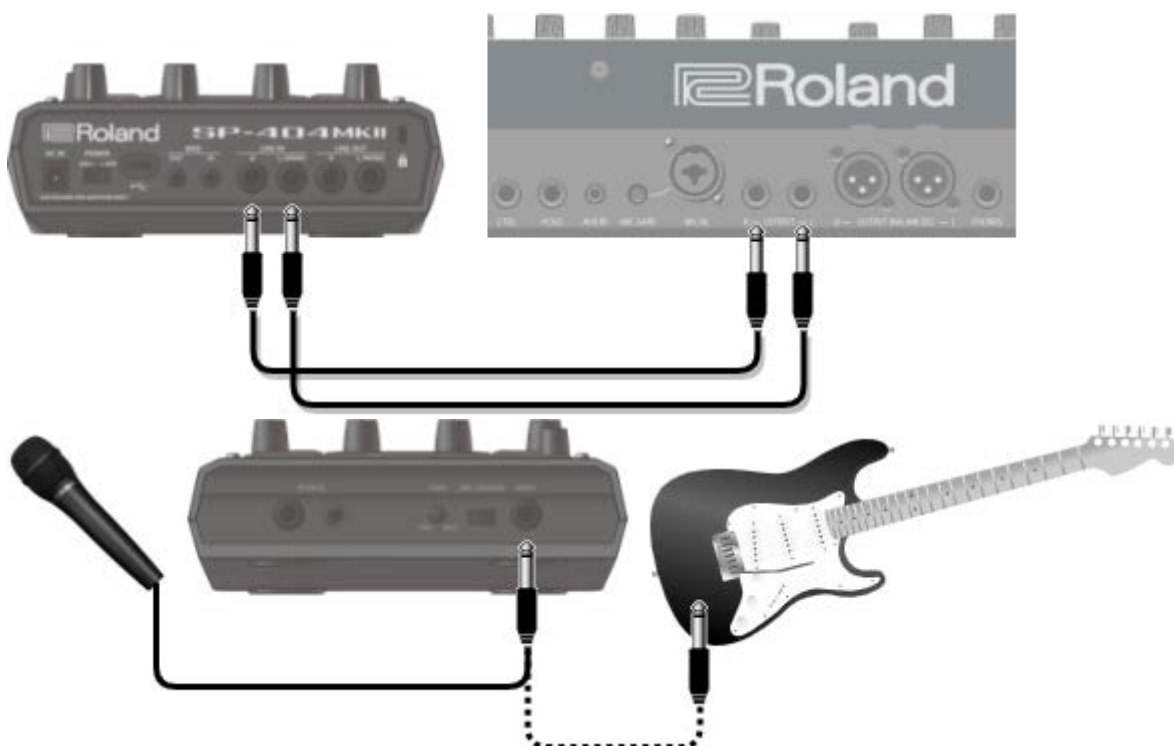

MEMO

You can change the input impedance of the INPUT jack on the front panel. When connecting a high-impedance instrument (such as a guitar or bass guitar), flip the [MIC/GUITAR] switch to the right (towards the INPUT jack).

Connecting to a Computer or Mobile Device

You can transmit and receive audio and MIDI data by connecting a USB cable from your computer or mobile device (smartphone or tablet) to the SP-404MK2.

You don't need to install a device driver on your computer or other device to do this (the SP-404MK2 supports USB Audio Device Class 2.0 specs).

MEMO

- Connecting the SP-404MK2 to your computer or mobile device lets you transmit/receive audio output and MIDI data to and from your computer or mobile device and the SP-404MK2.
- Note that data cannot be directly transmitted/received between the SP-404MK2 and your computer or mobile device if you're connecting through a USB hub.
- Do not use a USB cable that is designed only for charging a device. Charge-only cables cannot transmit data.
- We cannot guarantee the correct functionality of all apps.
- Android devices are not guaranteed to work with this unit.

Connecting to your computer

1. **Connect your computer and the SP-404MK2 using a USB cable with USB Type-C® connectors on both ends (commercially available).**

MEMO

- You can also use a USB Type-C® to USB A cable to connect your computer to the SP-404MK2. However, the computer cannot be used to power the unit in this case.
When using the latter type of cable, power this unit with the included AC adaptor, or use batteries.

Connecting to a mobile device

For iOS devices with Lightning connectors

1. **Connect the AC adaptor to the SP-404MK2, or use batteries.**
2. **For iOS devices, you must use an Apple-manufactured USB adaptor (such as the Lightning-USB Camera Adapter, the Lightning to USB 3 Camera Adapter and so on) as a converter for the jack.**
3. **Use a USB Type-C® to USB A cable (commercially available) to connect the SP-404MK2 to the USB adaptor.**

MEMO

- When connecting with a USB cable (USB Type-C® to USB A; commercially available), you cannot power this unit from your mobile device.
- Commercially available USB Type-C® to Lightning conversion cables cannot be used.

When using an iOS device with a USB Type-C® connector

1. **Connect your iOS device and the SP-404MK2 using a USB cable with USB Type-C® connectors on both ends (commercially available).**

When doing so, you can power the SP-404MK2 from your iOS device.

Inputting audio from a computer or mobile device

You must make the appropriate settings when inputting audio from a computer or mobile device. For details, refer to "Inputting Audio from a Computer or Mobile Device (USB AUDIO)(P.97)".

About the Power Supply

1. **Connect the included adaptor to the DC IN jack of this unit, and plug the adaptor into an AC outlet.**

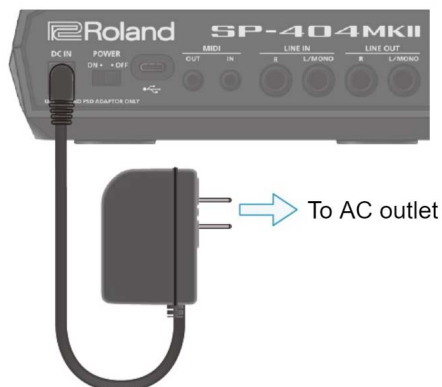

MEMO

- You can also use this unit without an adaptor, such as by supplying power to the USB port or by using batteries.
→ "[Powering the Unit via USB Port](#)(P.9)" "[Using Batteries](#)(P.8)"
- If the unit is using multiple power sources, the sources are prioritized in this order: DC IN jack (the included AC adaptor), USB port, batteries.

Using Batteries

Before installing/removing batteries, make sure to turn off the power to this unit and disconnect all connections to other devices.

When turning the unit over, be careful so as to protect the buttons and knobs from damage. Also, handle the unit carefully; do not drop it.

Remove the battery compartment cover located on the bottom of this unit, and insert the batteries in the correct polarity (direction) as marked inside the battery compartment.

Close the cover securely.

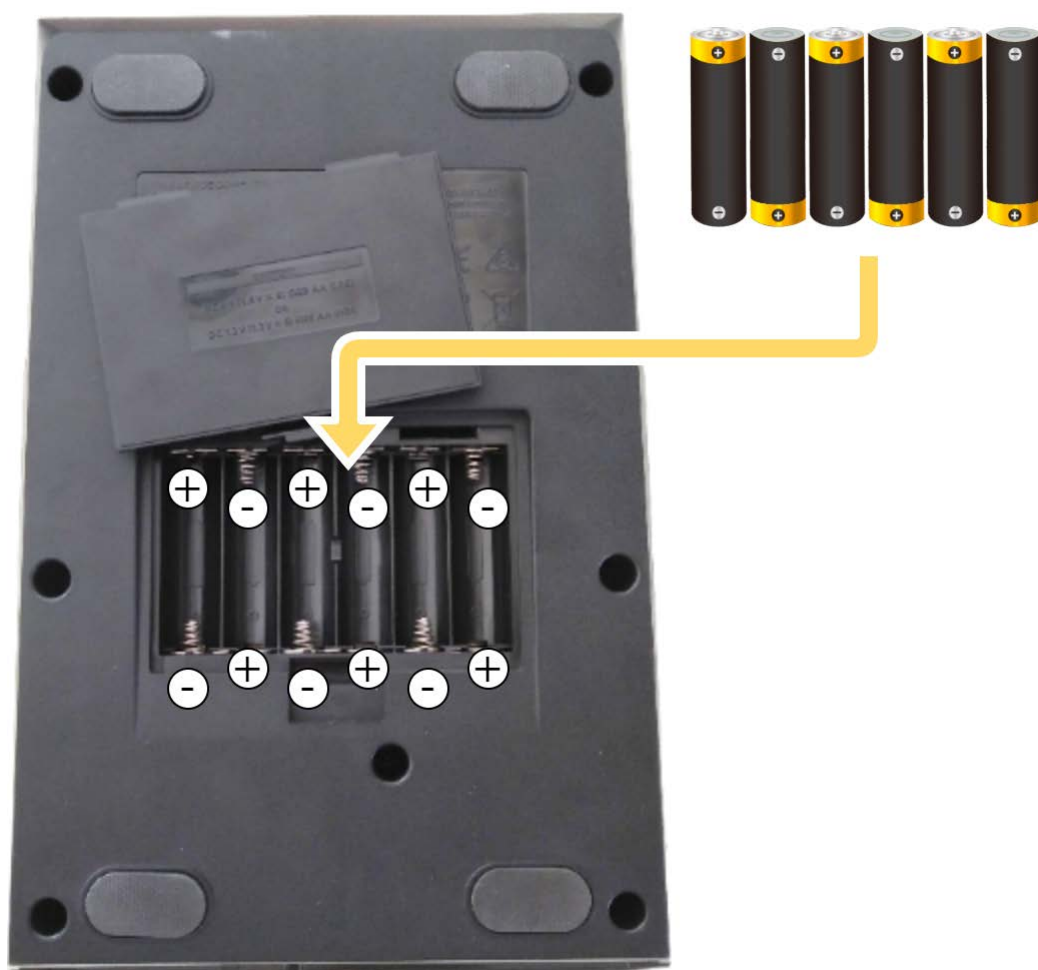

This unit uses six AA batteries (rechargeable Ni-MH or alkaline).

The unit can run for 3.5 hours on rechargeable Ni-MH batteries (1,900 mAh), and for 2.5 hours on alkaline batteries. (Note that these times may differ depending on the conditions of use and of the batteries.)

NOTE

If you handle batteries improperly, you risk explosion and fluid leakage. Make sure that you carefully observe all of the items related to batteries that are listed in leaflet "Read Me First" (USING THE UNIT SAFELY.)

Powering the Unit via USB Port

You can power this unit with a commercially available USB adaptor, from the USB port on your computer and from similar sources.

The following USB power sources can be used.

- **USB AC adaptor**
- **USB bus power (computer, etc.)**
- **Mobile battery**

MEMO

We cannot guarantee that this unit works universally with all USB AC adaptors, power from USB ports on computers or mobile batteries.

Conditions for powering this unit via USB port

When supplying power to this unit via the USB port, be sure to use a cable with USB Type-C® connectors on both ends. No other USB cables can be used, as they cannot provide enough power to operate the SP-404MK2. Also note that even when using cables that have a USB Type-C® connector on both ends, you cannot power this unit from devices like USB hubs with insufficient current output.

The USB port on the device from which this unit draws power must supply 5 V of output voltage and at least 1.5 A of output current.

When not enough power is supplied to the USB port

In the event that not enough power is supplied to the USB port of this unit (such as when you try to supply power from a USB Type-A connector or when the output current is less than 1.5 A), the message “Switch to batteries” appears.

When this happens, press the [VALUE] knob to switch to battery power. Note that if there are no batteries installed, the unit powers down.

Turning the Power On/Off

NOTE

Before turning the unit on/off, always be sure to turn the volume down. Even with the volume turned down, you might hear some sound when switching the unit on/off. However, this is normal and does not indicate a malfunction.

Turning the power on

1. To turn on the power, slide the [POWER] switch of this unit to “ON”.



2. Next, turn on any connected devices, and then the amp/speakers, in that order.
3. Adjusts the volume of the connected instrument.
4. Adjust the volume of this unit with the [VOLUME] knob.



About the sample mode display (top screen)

The top screen is shown once you turn on the power of the SP-404MK2 and the unit is ready to play.

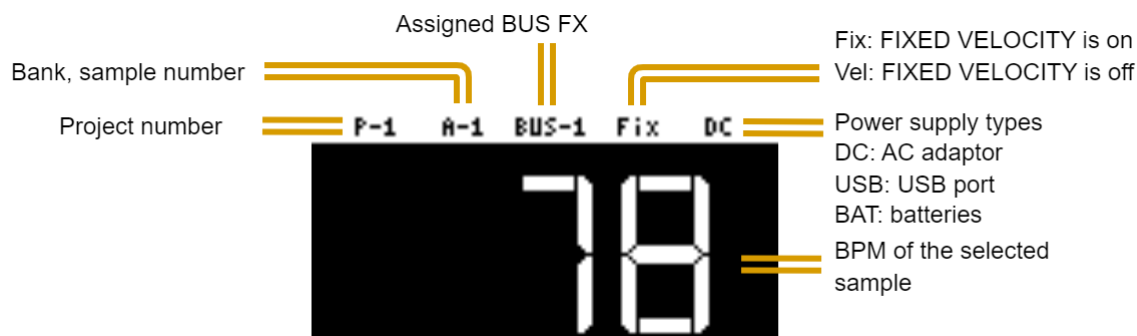

Turning the Power Off

1. Turn the volume of this unit and of your amp and speakers all the way down.
2. Turn off the power of your amp and speakers.
3. Slide the [POWER] switch of this unit to "OFF" to turn off this unit.

Playing Back Samples (SAMPLE MODE)

There are many preset samples available on this unit by factory default.

MEMO

When you turn on the SP-404MK2, the pads light up orange and the unit enters sample mode.



If the unit is not in sample mode, press the [EXIT] button a number of times. When the pads are blinking blue, press the [EXIT] button a number of times and then press the [PATTERN SELECT] button.

1. Press the pads of the SP-404MK2.

The corresponding samples play back.

MEMO

- Refer to “[Sampling \(SAMPLING\)](#)(P.37)” if you want to record a new sample.
- If you want to use samples that are already saved on your computer or other device, see “[Importing Samples \(IMPORT SAMPLE\)](#)(P.116).”

About sample playback mode

The way that samples play back when you press the pads depends on the playback mode set for the samples.

For details on each playback mode, refer to the following.

Playback mode	Reference
Gate	Playing Back Only While a Pad is Pressed (GATE) (P.15)
One-shot playback	Playing Back Samples Only One Time (One-shot Playback) (P.16)
Loop	Playing Back Samples Repeatedly (LOOP) (P.17)

Selecting a Sample Bank

Select the bank to use from the 10 available banks (A–J).

1. Press the bank [A/F]–[E/J] buttons.

The bank switches.

Each time you press the bank [A/F] button, the bank switches between A and F.

When bank A–E is selected, the bank [A/F]–[E/J] button lights up. When bank F–J is selected, the bank [A/F]–[E/J] button blinks.

Adjusting the Volume for All Banks (BANK VOLUME)

Adjusts the volume for the specified bank overall. This lets you adjust the volume if the volume varies between banks.

1. **Hold down the [SHIFT] button and press the bank [A/F]–[E/J] buttons.**

The BANK VOLUME screen appears.



2. **Turn the [VALUE] knob to set the bank volume.**
3. **When you are finished adjusting the values, press the [EXIT] button.**

MEMO

You may notice a difference in playback volume when copying or exchanging samples between different banks, due to the differences in the BANK VOLUME parameters set for each bank.

Playing Back a Sample to the Tempo of a Song (BPM SYNC)

You can synchronize the tempo (playback speed) of one sample with another sample.

You can also synchronize the tempo of a sample with that of an external device that's playing, such as a musical instrument or computer.

1. Press the [BPM SYNC] button.

This turns BPM SYNC on. The tempo of the sample then synchronizes with the bank tempo or the project tempo. The playback speed is adjusted so that the sample plays back at the right tempo.

MEMO

- Set which tempo is used as the sample's base tempo for playback in the system parameters.
For details, refer to "[Parameter Guide](#)(P.123)".
- To use BPM SYNC, you must first set the accurate tempo data for each sample.
For details, refer to "[Setting the Tempo Data in a Sample](#)(P.83)".
- You can make BPM SYNC synchronize either to the bank tempo or to the project tempo.
For details, refer to "[Setting the Tempo for a Bank or Project](#)(P.85)".
- To turn the BPM SYNC parameter on/off for all samples in a bank, press the [BPM SYNC] button while holding down the [SHIFT] button.

Playing Back Only While a Pad is Pressed (GATE)

This switches the gate function on/off.

When the [GATE] button is on, samples play back only while the pads are pressed (gate playback).

When the [GATE] button is off, samples begin playing back each time a pad is pressed.

MEMO

You can also use the gate function with the [EXT SOURCE] button.

- When the [GATE] button is turned on, the sound from the external device is output only while you are pressing the [EXT SOURCE] button.
- When the [GATE] button is turned off, the sound from the external device is switched on/off each time you press the [EXT SOURCE] button.

1. Press the [GATE] button to switch the function on (the button is lit) and off (the button goes dark).

MEMO

To turn the GATE parameter on/off for all samples in a bank, press the [GATE] button while holding down the [SHIFT] button.

Momentary gate control

Use the operations shown below to change how samples are played back.

Sample playback method	Operation
Stop the playback of samples whose GATE is off	Hold down the [EXIT] button and press pads [1]–[16].
Continue the playback of samples whose GATE is on	Press the [HOLD] button while holding down pads [1]–[16]. Hold down the [HOLD] button and press pads [1]–[16].

Playing Back Samples Only One Time (One-shot Playback)

When the sample playback mode is set to one-shot playback, the sample plays back once to the end when you press a pad.

The pad's operations are disabled (ignored) until playback is finished.

Even if a phrase that's shorter than the sample length is recorded in a pattern, the sample plays back to the end without returning to the beginning (no retriggering).

This characteristic is useful for playing a long sample as a backing track.

1. Hold down the [VALUE] knob and press the [GATE] button.

This sets the sample playback mode to "one-shot playback".

The [GATE] button blinks slowly at this time.

MEMO

The loop function turns off (and the [LOOP] button goes dark) when one-shot playback is on.

Playing Back Samples Repeatedly (LOOP)

Use the loop function to make a sample play back repeatedly. The loop settings can be made per sample.

When the [LOOP] button is turned on, the loop switches between playback and stopping with each press of the pad (trigger playback).

When the [LOOP] button is off, samples play back from the beginning each time a pad is pressed.

MEMO

When you hold down the [HOLD] button and press a pad (sample) whose loop is turned on, the sample plays back from the beginning (retrigger). In this case, pressing the pad does not make the sample stop.

Samples that are playing back in a loop play back from the beginning, making it sound like the loop was momentarily canceled.

Setting the loop to play back forwards

1. Press the [LOOP] button to turn the loop on (the button lights up).

The loop plays back forwards.



Setting the loop to play back in reverse

1. Press the [LOOP] button to turn the loop on (the button lights up).
2. Press the [REVERSE] button to turn reverse playback on (the button lights up).

The loop plays back in reverse.



Setting the loop to play back forwards and then backwards

1. Hold down the [SHIFT] button and press the [LOOP] button.

The [LOOP] button blinks. The loop alternately plays back forwards and then in reverse.

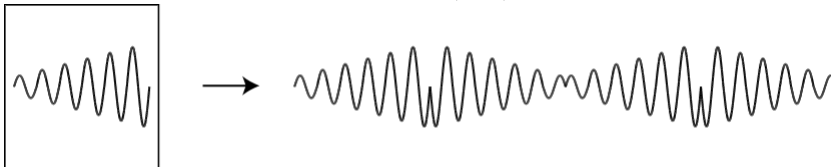

Playing Back a Sample in Reverse (REVERSE)

You can use the reverse function to play back samples in reverse (from end to start).

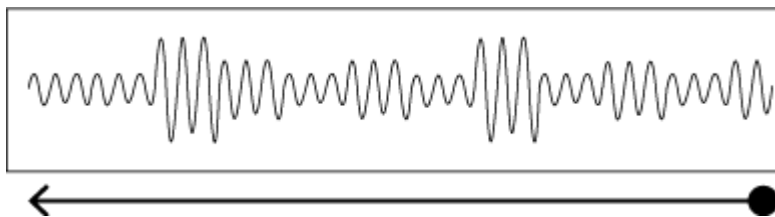

1. Press pads [1]–[16] to select the sample you want to play back in reverse.
2. Press the [REVERSE] button to turn reverse playback on (the button lights up).

Doing this sets the sample to play backwards.

MEMO

When you press the [REVERSE] button while a sample is playing back, the sample plays back in reverse. The point (time) where reverse playback starts differs depending on the REVERSE TYPE settings. See “Reverse Type(P.124)” in the system parameters for details.

Playing Back Samples in Detailed Steps (ROLL)

You can use the roll function to repeatedly play back samples at a set interval.

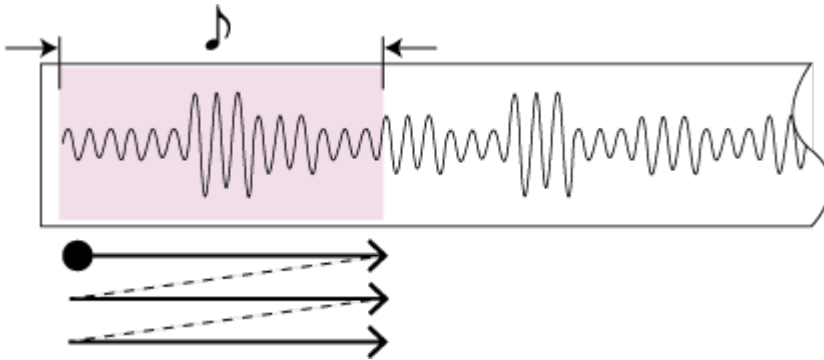

1. **Hold down the [ROLL] button and press pads [1]–[16].**

The sample plays back as a roll.

MEMO

You can play back up to four samples at the same time as a roll.

Using a roll during sample playback

You can make a sample roll while it is playing back.

1. **Press pads [1]–[16].**
The sample plays back.
2. **Press the [ROLL] button to turn the roll on (the button lights up).**
The sample plays back rolled.
3. **Press the [ROLL] button again to stop the roll while it is playing back.**

MEMO

The roll starts once you take your finger off the [ROLL] button after pressing it.

To play rolls with the correct timing, press the [ROLL] button just before the roll should begin, and take your finger off the button at the desired timing.

Setting the Roll Interval

This shows how to set the roll interval (how fast the roll repeats).

1. **Hold down the [SHIFT] button and press the [ROLL] button.**

Set the roll interval. Each time you press the [ROLL] button while holding down the [SHIFT] button, the roll interval changes as follows: quarter-note (1/4) → eighth note (1/8) → sixteenth note (1/16) → thirty-second note (1/32) → sixty-fourth note (1/64).



MEMO

If the roll interval (value) is longer than the sample length, the sample plays back in a loop.

The following are the conditions for roll playback or loop playback, when the tempo is 120 (bpm) and the sample length is less than a quarter note (0.5 sec.).

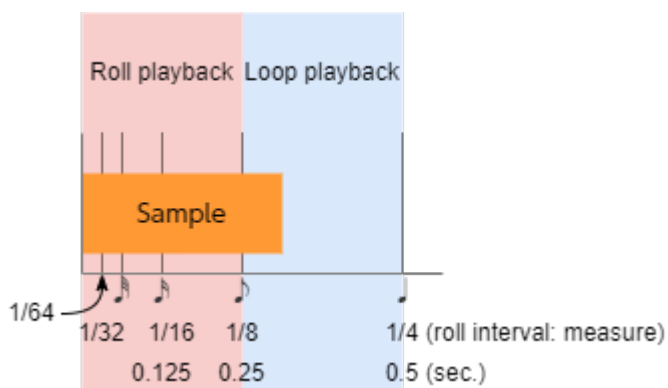

When the roll interval is set to 1/64–1/8, the sample plays back as a roll.
 When the roll interval is set to 1/4, the sample plays back in a loop.

Making the roll playback interval shorter (faster) partway through

You can shorten the roll interval while it is playing back.

1. Follow the steps in “Playing Back Samples in Detailed Steps (ROLL)(P.19)” to make the sample roll.
2. Hold down the [ROLL] button and turn the [VALUE] knob clockwise.

This shortens the roll interval. Turning the knob counter-clockwise returns the roll interval to its original value.

MEMO

You can't make the roll interval longer (slower) than the original value.

Setting a Fixed Sample Volume (FIXED VELOCITY)

You can set the sample's velocity so that it always plays back at 127 (the maximum).

1. **Hold down the [SHIFT] button and press the pad [1].**

"FIXED VELOCITY ON" is shown. The sample velocity is fixed at 127.

2. **To cancel this setting, hold down the [SHIFT] button again and press pad [1].**

"FIXED VELOCITY OFF" is shown. The velocity changes (goes back to the original setting) according to how hard you play the pads.

MEMO

The FIXED VELOCITY setting can be set for each sample.

For details, refer to "[Changing the Pitch or Playback Speed of a Sample \(PITCH/SPEED\)\(P.52\)](#)".

Changing the Sample Volume for Playback (16 VELOCITY)

You can use the 16 VELOCITY function to change a sample's velocity (volume) in steps when it plays back.

1. Press pads [1]–[16] to select the sample you want to use with the 16 VELOCITY function.
2. Hold down the [SHIFT] button and press the pad [2].

The 16 VELOCITY screen appears.

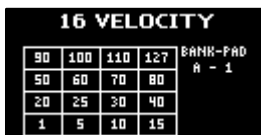

16 VELOCITY				BANK-PAD
90	100	110	127	A - 1
50	60	70	80	
20	25	30	40	
1	5	10	15	

3. Press pads [1]–[16].

The pad position corresponds to the velocity shown. The sample plays back at the velocity that matches the pad you press.

4. To exit 16 VELOCITY, press the [EXIT] button.

Playing Back Samples in Scale Pitches (CHROMATIC)

You can play back samples (changing their pitches) as a chromatic scale with the pads.

1. Press pads [1]–[16] to select the sample to use in chromatic mode.
2. Hold down the [SHIFT] button and press the pad [4].

The unit enters chromatic mode.



3. Press pads [1]–[16].

The pad position corresponds to the key displayed. The sample plays back in the key that matches the pad you press.

MEMO

Turn the [VALUE] knob to change the key range.

4. To exit chromatic mode, press the [EXIT] button.

Changing how the samples play (how they sound)

You can change how samples play when they are triggered.

1. In chromatic mode, press the [REMAIN] button.

The method switches each time you press the [REMAIN] button.

Method of playing	[REMAIN] button	Explanation
LEGATO	Blinks slowly	When you play legato (by pressing a pad while holding down another pad), portamento is applied.
MONO	Lights up	The sample plays in single-note mode (monophonic).
POLY	Blinks quickly	Pressing multiple pads makes the samples play back at the same time (polyphonic).

Changing the scale/mode

You can change the scale/mode that's used when you play.

1. In chromatic mode, press the [VALUE] knob.

The scale/mode changes in the following order each time you press the [VALUE] knob.

Major scale → minor scale → Dorian mode → Phrygian mode → major scale → ...

Hold down the [ROLL] button and turn the [VALUE] knob to select the note (root) for the scale.

Muting the Playback of a Sample (PAD MUTE)

You can momentarily mute (silence) the playback of a sample.

By using part mute on a sample that's playing back, you can create a break.

MEMO

When a pattern is selected (the pad lights up purple), the pad can't be muted. To mute a pad, press the [PATTERN SELECT] button and switch to sample mode (the pad lights up orange).

1. **Press a pad to play its sample.**
2. **Hold down the [SHIFT] button and [REVERSE] button and press the pad (sample) you want to mute.**

The pad (sample) is muted. Muted pads (samples) light up red.

You can mute individual samples, either one or more than one, or mute individual samples when a pattern is playing back.

MEMO

If you press the [REVERSE] and [REMAIN] buttons while holding down the [SHIFT] button, the [SHIFT] and [REVERSE] buttons remain in a pressed-down state, even after you take your fingers off the buttons.

This makes it easier to mute or unmute multiple pads. Press the [EXIT] button to cancel this behavior.

3. **To unmute a pad, hold down the [SHIFT] button and [REVERSE] button and press the pad (sample) you want to unmute.**

MEMO

You can also unmute a pad by pressing the [EXIT] button four times to stop the sample playback.

MEMO

When PAD MUTE (SYSTEM parameter) is set to "MASTER," the sound of the pad can be output from the PHONES jack, even if the pad (sample) is muted (this lets you monitor the sounds from the pads). In this case, no effects are applied. Refer to the "Pad Mute(P.123)" SYSTEM parameter for details.

Playing Back Multiple Pads at the Same Time (PAD LINK GROUPS)

The PAD LINK GROUPS function lets you group multiple pads (up to four) into one group. By setting a group ahead of time, you can make all the pads in the group play back just by operating a single pad within that group.

You can also register up to 10 groups (A–J).

1. **Hold down the [SHIFT] button and press the pad [7].**

The PAD LINK GROUPS screen appears.



2. **Turn the [VALUE] knob to select the group (A-J).**
3. **Press pads [1]–[16] to select the samples you want to include in the group.**
4. **To finish making setting, press the [EXIT] button.**
5. **Press one of the pads that you set in the group.**

All the pads in the group play back at the same time.

Preventing Samples from Playing Back at the Same Time (MUTE GROUP)

The MUTE GROUP function lets you group together all the samples that should not play at the same time (in other words, the samples you don't want to layer).

When you try and play the samples within that group all at the same time, only the sample that started playing back last is heard.

A group can consist of up to 16 samples. You can also register up to 10 groups (groups A–J).

1. **Hold down the [SHIFT] button and press the pad [8].**

The MUTE GROUP screen appears.



2. **Turn the [VALUE] knob to select the group (A–J).**
3. **Press pads [1]–[16] to select the samples you want to include in the group.**
4. **To finish making the settings, press the [EXIT] button.**

Out of the pads (samples) in the same group, sound is played back only for the last pad you play.

Stopping All Sample Playback (STOP)

You can make all samples and patterns that are currently playing back stop.

1. **Press the [EXIT] button quickly four times.**

All samples and patterns that are playing back stop.



MEMO

You can also press the [EXIT] button while holding down the [SHIFT] button to stop all samples and patterns that are playing back.

Pausing the Sound of a Sample (PAUSE)

You can make samples that are currently playing back pause.

1. **Hold down the [SHIFT] button and press the [HOLD] button.**

All samples that are playing back pause.



2. **Hold down the [SHIFT] button and press the [HOLD] button again to resume playback.**

The samples resume playback.

Disabling Buttons that Are Not Used When Playing Live (LIVE MODE)

Normally, the buttons related to features like sampling and editing are not used when you are playing live.

Accidentally pressing these buttons while you're performing live might be a show-stopper.

By turning live mode on, you can disable these buttons and avoid such accidents.

1. **Hold down the [SHIFT] button and long-press the [REMAIN] button for at least three seconds.**

This turns live mode on, and the  icon appears in the lower left corner of the screen.



The following buttons are disabled in live mode.

- [DEL] button
- [REC] button
- [RESAMPLE] button
- [COPY] button
- [MARK] button

To turn live mode off, perform the same operation as described above.

Using the Effects

You can use the built-in effects on the SP-404MK2 to process the audio in unique ways.

Use the built-in effects on the SP-404MK2 by assigning them to a bus (an audio routing inside the SP-404MK2).

With BUS 1 and BUS 2, you can apply the effects that are appropriate for your performance, per sample. BUS 3 and BUS 4 are mainly used to apply effects to the overall sound output from the SP-404MK2.

There are two kinds of bus routings (in connection order) that you can select as you like.

BUS FX Type A

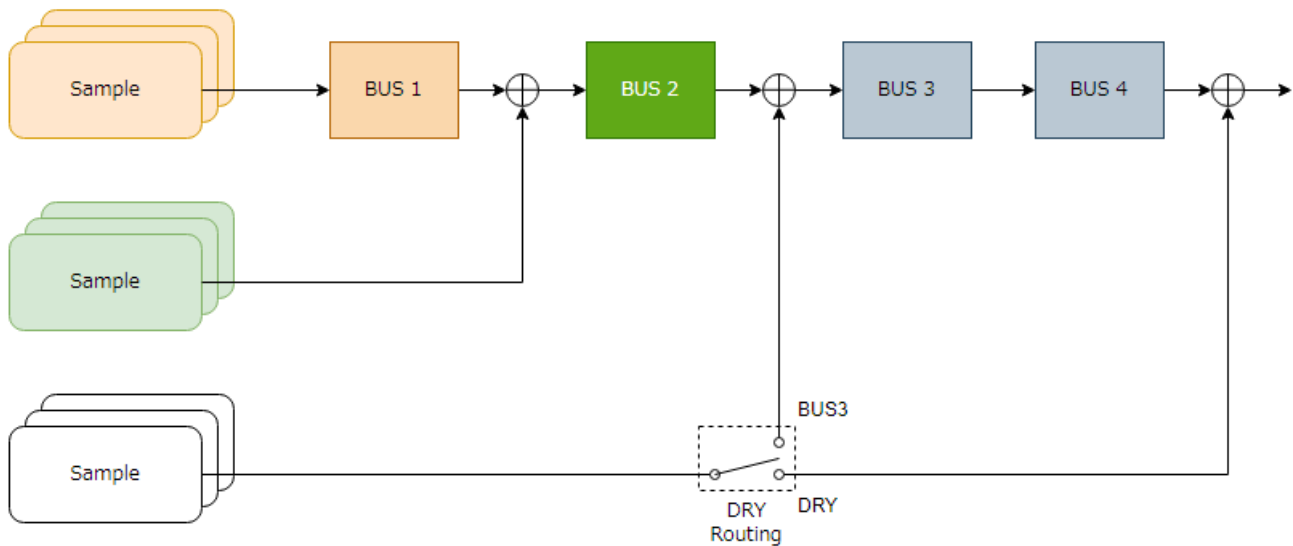

BUS FX Type B

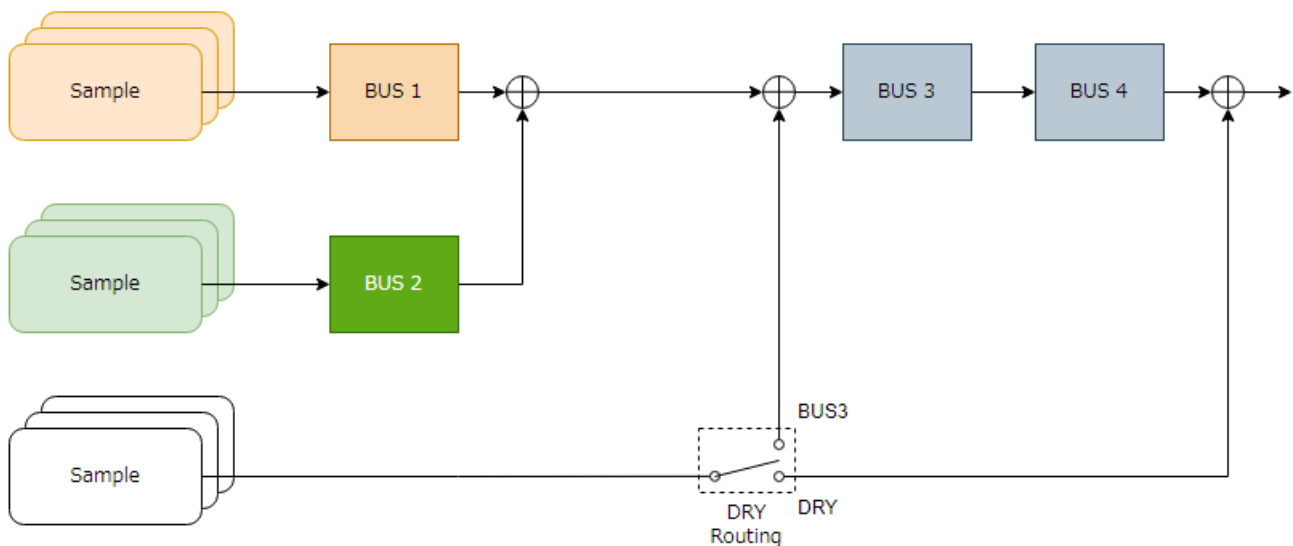

Refer to “[Configuring the Effect Routing\(P.108\)](#)” for how to edit the bus routings.

To switch between DRY Routing parameters, see “[DRY Routing\(P.128\)](#)” in EFX SET.

Adding Effects to a Sample (BUS FX)

You can use the various effects built into the SP-404MK2 to process the playback audio in unique ways.

1. **Press the effect buttons.**



Press the buttons of the effects you want to apply, including the [FILTER+DRIVE] button, the [RESONATOR] button, the [DELAY] button, the [ISOLATOR] button, the [DJFX LOOPER] button, and the [MFX] button. This turns the effects on.

2. Press pads [1]–[16] to play back the samples.

Effects are applied to the samples.

3. Use the [CTRL 1]–[CTRL 3] knobs to adjust the parameters.

The parameters change how the effects are applied.



You can also access the effect sub-parameters by holding down the [VALUE] knob and operating the knobs.



MEMO

You can assign the effects you like to the effect buttons. For details, refer to “Assigning the Desired Effect to an Effect Button (DIRECT FX)(P.111)”.

Assigning Effects to BUS 1 and BUS 2

Here’s how to assign the built-in effects of this unit to BUS 1 or BUS 2. You can use two types of effects separately.

1. Press the [BUS FX] button to select the bus to configure.

When the button is lit orange, BUS 1 is selected; and when the button is blinking orange, BUS 2 is selected.

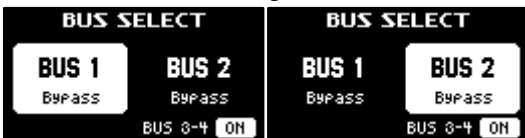

2. Press the [FILTER+DRIVE]–[MFX] buttons to select the effect to assign to the bus.

MEMO

You can assign the built-in effects of this unit to BUS 3 or BUS 4. Up to four effects are available. To assign an effect to BUS 3 or BUS 4, change the settings in the effect setting screen. —“Configuring the Effect Settings (EFX SET)(P.108)”

Deciding on Effects to Use for Each Sample

Sets which sample playback audio is sent to which bus (meaning which effects are used) for each sample.

In this example, we apply the effect assigned to BUS 2 to the sample on pad [1].

MEMO

Set which effect is applied to the bus beforehand. For details, refer to “Assigning Effects to BUS 1 and BUS 2(P.30)”.

1. Press the [BUS FX] button to select BUS 2.



2. Hold down the [REMAIN] button and press the pad [1].

The playback audio for the sample assigned to pad [1] is sent to the effect assigned to BUS 2.

Pad [1] lights up green at this time.

MEMO

The pad's color tells you the bus to which the sample is sent.

Pad color	Audio send destination (bus)
Lit orange	BUS 1
Lit green	BUS 2
Lit white	The sound is not sent to BUS 1 or BUS 2 (DRY).

Preventing samples from being sent to BUS 1/BUS 2

You can prevent the playback audio of samples from being sent to BUS 1 or BUS 2 (DRY). In this case, no effects are applied to the samples.

1. While holding down the [REMAIN] button, press the pad [1]–[16] buttons a number of times to make them light up white.

The BUS 1 and BUS 2 effects are not applied to the samples of pads that are lit up white.

Sending the audio input from the INPUT jack to a bus

As with the samples, you can set the bus to which the playback audio signals coming into the INPUT jack are sent (meaning which effects are used).

For details, refer to “Sending the Audio Input from the INPUT Jack to a Bus(P.113)”.

Using the MFX Effects

You can select and use the effects you like for the MFX effects.

1. While holding down the [MFX] button, turn the [VALUE] knob or the [CTRL 3] knob to select the effect to use.

**MEMO**

You can also use pads [1]–[16] instead of the [VALUE] knob or the [CTRL 3] knob to select an effect.

To use pads [1]–[16] to select effects from #17 and up, hold down the [MFX] button and the [DJFX LOOPER] button at the same time.

2. After selecting the effect, take your finger off the [MFX] button.

The effect turns on, and the effect edit screen appears.



3. Play back a sample.
4. Use the [CTRL 1]–[CTRL 3] knobs to adjust the parameters.

You can also access the effect sub-parameters by holding down the [VALUE] knob and operating the knobs.

Editing the Effects

When you press an effect button (such as the [FILTER+DRIVE] button) to turn the effect on, the effect edit screen appears.

Turn the [CTRL 1]–[CTRL 3] knobs while the effect edit screen is displayed to edit the main parameters of the effect.

You may be able to access the sub-parameters by holding down the [VALUE] knob, depending on the effect. Turn the [CTRL 1]–[CTRL 3] knobs to edit the sub-parameters of the effect.

Locking the effect edit screen

Although the effect edit screen displays when you press an effect button, the screen normally returns to the previous screen if you don't operate any controls for several seconds.

You can use the following operation if you want to make the effect edit screen keep displaying.

1. **While holding down the [REMAIN] button, press an effect button (such as the [FILTER+DRIVE] button).**

The effect edit screen appears. Even if you don't operate the unit for a while after this, the unit does not return to the previous screen.



The display switches between main parameters and sub-parameters each time you press the [VALUE] knob, depending on the effect.



2. **To exit the settings, press the [EXIT] button or the [REMAIN] button.**

How the effect parameters are saved and shared

Parameters that are retained even after you turn off the power of this unit are shown below.

Bus to which effects are assigned	Main parameters	Sub-parameters
INPUT (INPUT FX)	✓	✓
BUS 1	✓ (*)	
BUS 2		
BUS 3	✓	✓
BUS 4		

(*) The main effect parameters assigned to BUS 1 and BUS 2 are saved when you hold down the [MARK] button for at least three seconds while holding down the [SHIFT] button.

The effect parameters on this unit are shared in common with some buses to which effects are assigned.

For instance, the sub-parameters of effects assigned to INPUT, BUS 1 and BUS 2 are shared in common. For this reason, when you assign the same effect to INPUT and BUS 1 and then change the INPUT FX sub-parameters, the BUS 1 sub-parameters become the same values.

The effect parameters are likewise shared between BUS 3 and BUS 4 as well.

Turning Effects On/Off at the Desired Timing

You can make effects apply only while you hold down the effect buttons (EFFECT GRAB).

This lets you quickly turn an effect on/off in time with what you play.

1. **Play back a sample.**
2. **While holding down the [VALUE] knob, press an effect button (such as the [FILTER+DRIVE] button).**

The effect turns on only while you're pressing the effect button.

Temporarily Output Only the Effect Sound (MUTE BUS)

You can temporarily mute the audio (the sample playback sound or the audio coming into the INPUT jack) that's sent to a bus, and output only the sound of the effect.

This lets you output just the sound of reverberation or delay feedback to create a break when you're playing.

1. **Play back a sample.**
2. **Hold down the [SHIFT] button and press the [BUS FX] button.**

MUTE BUS turns on. This shuts off the audio signal sent to the bus.



3. **To turn MUTE BUS off, hold down the [SHIFT] button and press the [BUS FX] button again.**

MUTE BUS turns off. This allows the audio signal to be sent to the bus. At the same time, the effects assigned to the bus turn off.

How MUTE BUS works

The MUTE BUS feature works in a complex way to control the audio sent to the buses and the effects at the same time.

This shows the audio signal flow when using MUTE BUS.

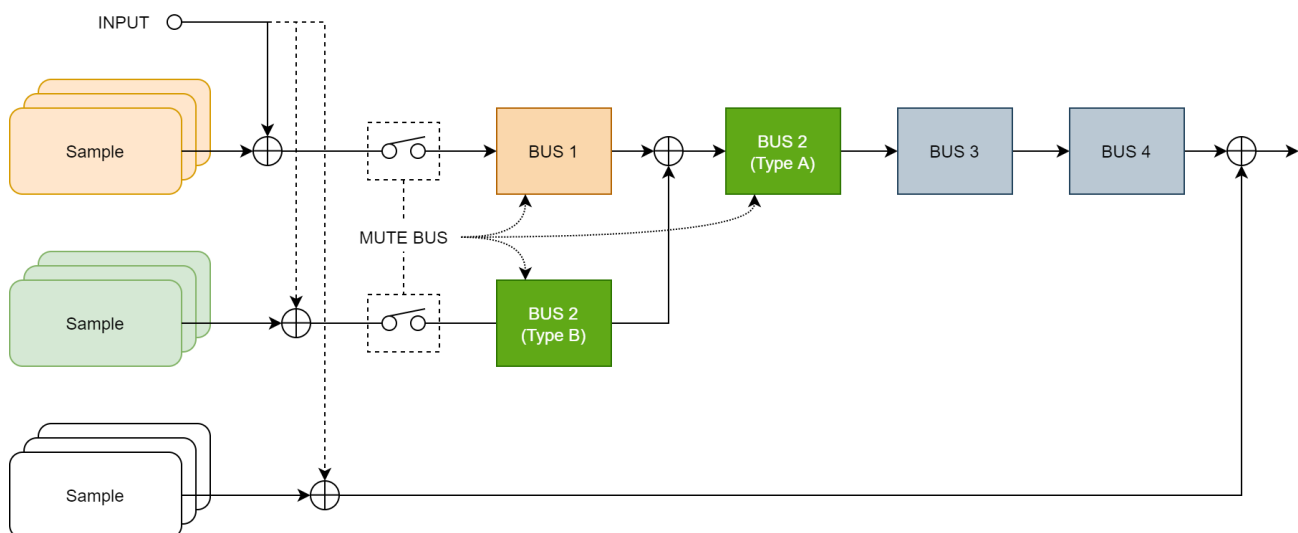

Also, the diagram below shows how the audio outputted from this unit changes when you turn MUTE BUS on/off.

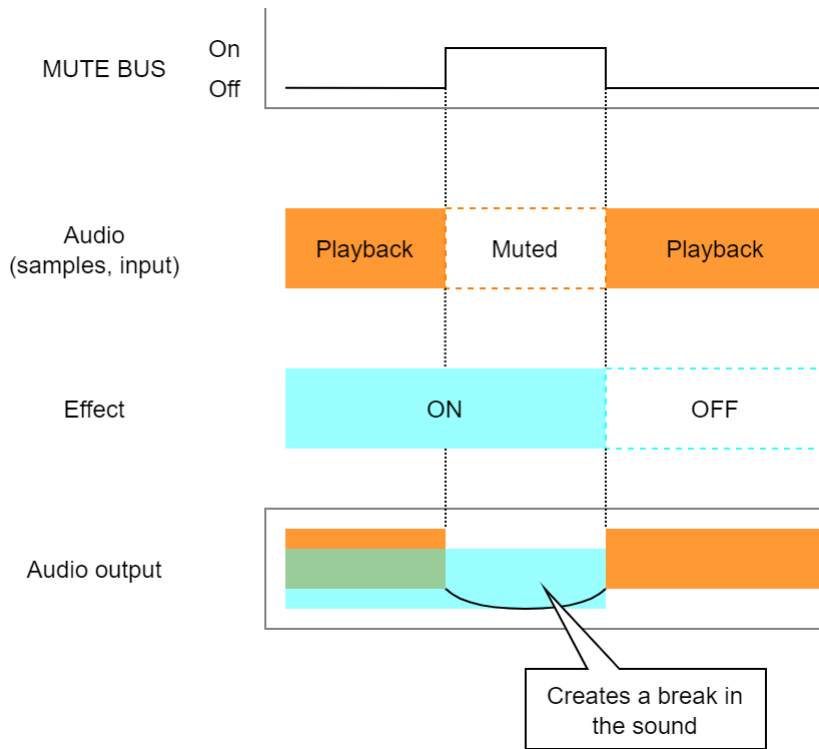

Individually selecting the bus to mute with MUTE BUS

When MUTE BUS is turned on, you can individually select the buses on which audio is muted.

For details, refer to the "Mute Bus" parameter listing in the "EFX SET(P.127)".

Sampling (SAMPLING)

You can sample (record) the sound that's inputted into this unit to create your own samples (audio data materials).

Configuring the Sampling Settings (RECORD SETTING)

Here you can configure the settings for sampling, such as the recording level, as well as apply input effects to the sound input from an external source.

1. In sample mode, press the [REC] button.

The unit enters sampling standby mode.

2. Press the [RECORD SETTING] button.

The input setting screen appears.



3. Use the controllers to edit the parameters.

Controller	Parameter	Value	Explanation
[CTRL 1] knob	REC BPM	40.0–	Specifies the tempo. Use the [CTRL 1] knob while holding down the [SHIFT] button to set the value more precisely. You can also set the tempo using the tap tempo function. “Setting the Tempo in Time with the Rhythm (Tap Tempo)(P.86)”
[SHIFT] button + [CTRL 1] knob		200.0	
[CTRL 2] knob	ROUTING		This selects the source to sample (the input source).
		Mix	Samples the mixed audio from this unit (the playback audio) and the input from an external source.
		ExtIn	Samples only the audio input from an external device.
[SHIFT] button + [CTRL 3] knob	PAN	L:50– R:50	Adjusts the pan position (the left-right volume balance when sampling).
[CTRL 3] knob	LEVEL	0–127	Adjust the recording level.

Configuring the Input Effects (INPUT FX)

The INPUT FX (input effects) are effects used only for the input jacks. You can apply effects to the audio that's inputted to this unit.

1. On the input setting screen, press the [VALUE] knob.

The INPUT FX Setting screen appears.



2. Use the [VALUE] knob to move the cursor to “EFX Type”, and press the [VALUE] knob.

The value display is highlighted, and you can now change the effects.

Parameter	Value
EFX Type	Bypass, Auto Pitch(*), Vocoder(*), Harmony(*), Gt Amp Sim(*), Chorus, JUNO Chorus, Reverb, TimeCtrlDly, Chromatic PS, Downer, WrmSaturator, 303 VinylSim, 404 VinylSim, Cassette Sim, Lo-fi, Equalizer, Compressor

MEMO

Effects marked with an (*) are for INPUT FX only.

3. Use the [VALUE] knob to select the effect, and press the [VALUE] knob.

This sets the effect.



INPUT FX Settings		
EFX Type: Auto Pitch		
PITCH	FORMANT	BALANCE
-100	-100	0-100
AT PITCH	KEY	ROBOT
50	CHROMA	OFF

4. Use the [VALUE] knob to move the cursor to the parameter that you want to edit.
5. Use the [CTRL 1]–[CTRL 3] knobs to adjust the parameters.

For details on the various effect parameters, refer to “[MFX List\(P.129\)](#)”.

MEMO

Some effect parameters may be shared in common, depending on the bus to which the effect is assigned. For details, see “[How the effect parameters are saved and shared\(P.33\)](#)”.

Sampling

This shows how to sample (record) the audio that's inputted into this unit to create your own samples.

1. **Press the [REC] button.**



Empty pads to which samples haven't been assigned blink red.

MEMO

The metronome sounds when the "Metronome:REC" parameter is "ON" (the SYSTEM parameter "CLICK(P.124)"). Press pad [9] while holding down the [SHIFT] button to turn the metronome sound on/off.

2. **Use the [CTRL 1] knob to adjust the tempo during sampling (the sample tempo), and use the [CTRL 3] knob to adjust the volume of audio input from an external device.**

MEMO

You can also set the tempo using the tap tempo function. For details, refer to "Setting the Tempo in Time with the Rhythm (Tap Tempo)(P.86)".

3. **Press the pads [1]–[16] that are blinking red.**
4. **Press the [REC] button.**
Sampling begins.
If you decide to cancel sampling, press the [EXIT] button.
5. **To quit sampling, press the pads [1]–[16] used for sampling or the [REC] button once more.**
The sample is saved to the pad.

Adding a Count-in Before Sampling

This feature adds a count-in before sampling begins. This gives you time to get ready to play before sampling actually begins.

1. **Hold down the [SHIFT] button and press the pad [10].**

The value changes in order each time you press pad [10] while holding down the [SHIFT] button. Edit the count-in setting.



Value	Explanation
COUNTIN 1MEAS	Adds a one-measure count-in before sampling.
COUNTIN 2MEAS	Adds a two-measure count-in before sampling.
COUNTIN WAIT	When the input audio signal exceeds the level set in the Auto Trig Level parameter, sampling begins.
COUNTIN OFF	No count-in is used. Sampling starts immediately after you press the pads [1]–[16] to sample and then press the [REC] button.

Automatically Setting the End Point of a Sample (END SNAP)

By setting the BPM (tempo) and then sampling, you can automatically set the beat that's just before the sampling end beat as the "end point" (the timing at which the sample stops).

1. **Press the [REC] button.**

Empty pads to which samples haven't been assigned blink red.

2. Press the [START/END] button.

END Snap is enabled. "END Snap ON" is displayed, and the [START/END] button lights up.



To disable END Snap, press the [START/END] button again. "END Snap OFF" is displayed, and the [START/END] button blinks.



3. Sample by following steps 2 and onward in "Sampling (SAMPLING)(P.37)".

MEMO

You can use the END SNAP function when resampling or a rehearsing a pattern.

Sampling result when END SNAP is off

The end point is set at the end of the sample.



Sampling result when END SNAP is on

The end point is set at the beat near the end of the sample.

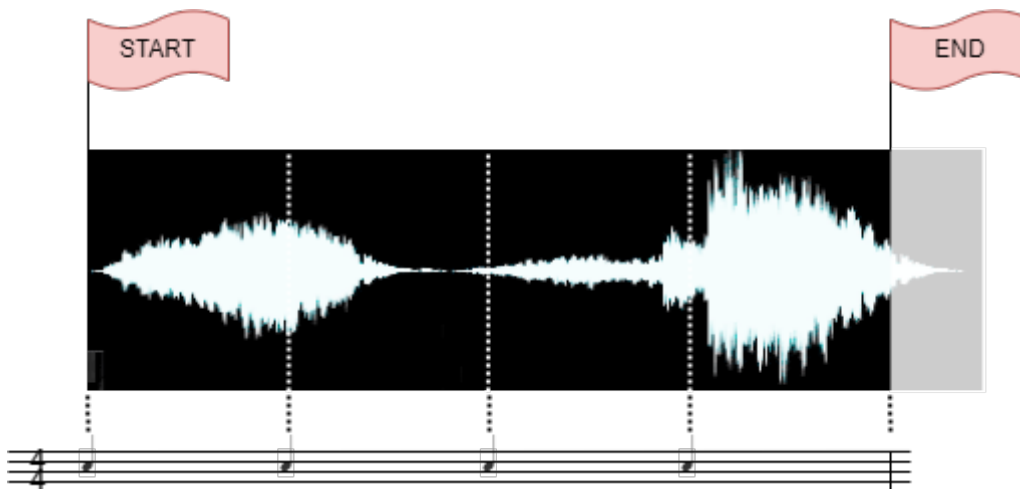

Resampling a Sample (RESAMPLE)

Resampling means sampling a sample itself while it's playing back. You can sample the sound of a sample to which effects are applied, or sample the sound of multiple samples that are playing back at the same time, creating a single sample.

MEMO

Also, by turning the pattern sequencer on beforehand (the [PATTERN SELECT] button lights up), you can resample a pattern in the same way as you would resample a sample.

1. Press the [RESAMPLE] button.



MEMO

The metronome sounds when the "Metronome:REC" parameter is "ON" (the SYSTEM parameter "CLICK(P.124)"). Press pad [9] while holding down the [SHIFT] button to turn the metronome sound on/off.

2. Press the [RECORD SETTING] button.

The input setting screen appears.



3. Use the [CTRL 2] knob to set ROUTING to "Mix".

MEMO

When ROUTING is set to "ExtIn", only the audio input from an external device is sampled (the sample's audio is not included in the resample). You can sample your performance while playing back samples as backing sounds.

4. Use the [CTRL 1] knob to adjust the tempo during sampling (the sample tempo), and use the [CTRL 3] knob to adjust the volume of audio input from an external device.
5. Press the [EXIT] button or the [RESAMPLE] button.
6. Press pads [1]–[16] that are blinking red.

The empty pads to which samples haven't been assigned blink red.

When you press an empty pad, the pad lights up orange, and a message "Press Pad to START" is shown.



7. Press pads [1]–[16] to select a sample.

Sampling begins when the pattern starts playing back.



If you decide to cancel sampling, press the [EXIT] button.

MEMO

You can also press the [REC] button to begin sampling. You can begin sampling when you want, while playing back samples as backing sounds.

8. To quit sampling, press the pads [1]–[16] used for sampling or the [REC] button once more.

The sample is saved to the pad.

Sampling What You Previously Played (SKIP-BACK SAMPLING)

You can sample what you played up to 25 seconds ago (default) using the skip-back sampling function, which works even if you hadn't started sampling.

This lets you “go back in time” to sample a passage you played well during repeated practice, or to sample a phrase you played well when you were just improvising.

1. **Play back a sample or pattern, or switch the [EXT SOURCE] button on and play the instrument that's connected to this unit.**

When the unit detects an audio level at or above a certain level, the unit begins recording to skip-back memory (which is used only for sampling past audio signals). At this time, the [MARK] button blinks.

2. **Press the [MARK] button.**

After “SKIP BACK...” appears, the waveform of the audio in skip-back memory is displayed.

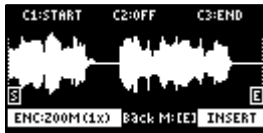

3. **Press the [REC] button.**

“Select Pad To Save” appears. Empty pads to which samples haven't been assigned blink red.



4. **Press pads [1]–[16] to select the pad to which you want to assign the skip-back memory audio.**

Now the audio from skip-back memory is assigned to the pad.

NOTE

Once you press the [EXIT] button without assigning the skip-back memory audio or turn off this unit, the skip-back memory is lost.

If you want to keep the skip-back memory audio, make sure to assign it to a pad.

MEMO

When you set the “SBS Time” system parameter to “Long”, the maximum time available for recording to skip-back memory can be set to a maximum of 40 seconds.

See “SBS Time(P.123)” in the system parameters for details.

Skip-back sampling: how it works, and what its restrictions are

- **Skip-back memory records up to 25 seconds (default) of audio. Anything recorded more than 25 seconds ago is erased, and can't be previewed or sampled.**
- **The skip-back memory audio starts and pauses recording according to the setting of the Auto Trig Level parameter. When the input audio signal exceeds the level set in the Auto Trig Level parameter, skip-back memory starts recording. When the input audio signal falls below the level set in the Auto Trig Level parameter for at least three seconds, skip-back memory recording is paused.**
- **Skip-back memory is not recording if the [MARK] button is not blinking, and thus can't be previewed or sampled. If you press the [MARK] button at this time, the message “No SKIP BACK Trigger Data” is shown.**

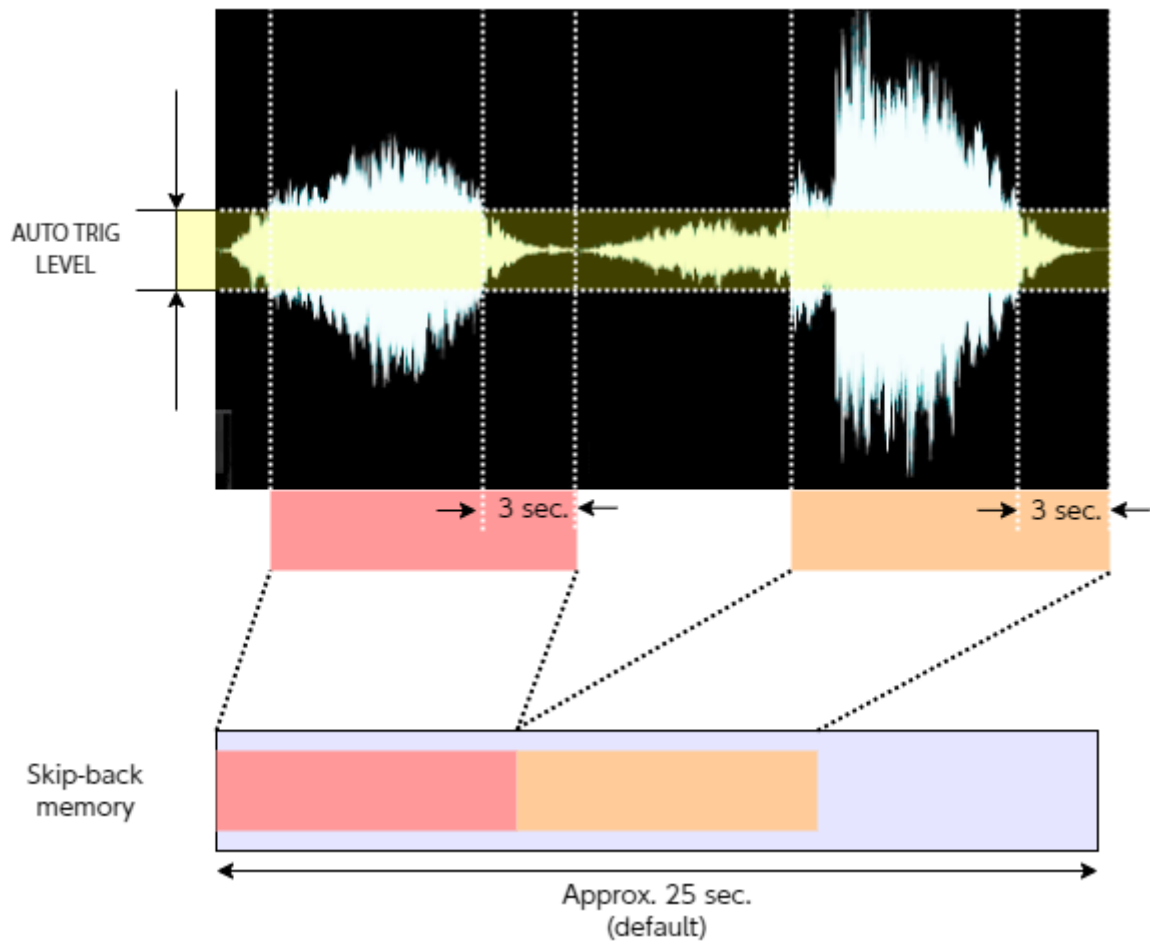

Editing a Sample (SAMPLE EDIT)

You can edit the playback speed, waveform and other parameters for the samples.

Setting the Playback and Loop Regions (START/END)

You can prevent unnecessary parts of a sample from playing, such as silence or noise at the beginning or at the end.

This shows you how to set the start point (where a sample begins playing back) and the end point (where a sample stops playing back). You can also use the same operations to set the loop point (the starting point for loop playback).

1. Press the [START/END] button.

The marker setting screen appears.

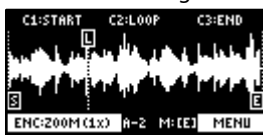

2. Press pads [1]–[16] to select the sample you want to edit.

3. Use the [CTRL 1]–[CTRL 3] knobs to adjust the start and end points.

Controller	Operation
[CTRL 1] knob	Moves the start point.
[CTRL 2] knob (when the loop is on)	Moves the loop point.
[CTRL 3] knob	Moves the end point.
[SHIFT] button + [CTRL] knob (turn)	Zooms the area around each point in/out.
[VALUE] knob (turn)	Zooms the area in/out around each point you just manipulated.
[SHIFT] button + [VALUE] knob (press)	You can use a numerical value to set the position of each point. Use the [VALUE] knob to select the point to set, and press pads [1]–[10] to input the position (press pad [10] to input a "0"). To confirm the inputted position, press the [VALUE] knob.
[DEL] button	Initializes the start and end point positions. <ul style="list-style-type: none"> When a confirmation message appears, use the [VALUE] knob to select "OK", and press the [VALUE] knob.
[REMAIN] button	On: Prevents the start point from being moved beyond the loop point or the end point. Off: When the start point moves beyond the loop point or the end point, this moves the loop point or the end point as well.
[MARK] button	When this button is pressed while a sample is playing back, this sets the start point and end point in order. <ul style="list-style-type: none"> The loop point is set to the same position as the start point.
[ROLL] button	While this button is pressed, you can preview the sound several seconds before the end point.
[RESAMPLE] button	Moves the start point to the zero cross-point (*) that's closest to the start point time (SNAP to Zero-Cross function). Similarly, the loop point and end point are also moved. This function is enabled when the [RESAMPLE] button is lit. <ul style="list-style-type: none"> The "zero cross-point" is the time at which the value of the sample waveform crosses from zero into a positive or negative number. <div style="text-align: center;"> <p>The diagram shows a sine wave on a coordinate system with a vertical axis labeled '+', '0', and '-'. The horizontal axis represents time. Five red circles are placed on the horizontal axis at the points where the wave crosses from positive to negative or negative to positive. An arrow points to the rightmost of these circles, which is labeled 'Zero cross-point'.</p> </div>

4. Once you've confirmed the start/end point, press the [EXIT] button.

Processing a Sample

You can use the start point and end point settings to process a sample.

NOTE

Note that this operation directly processes the original sample data. Once you process a sample in this way, it cannot be restored.

1. Set the start and end points by following the steps in “Setting the Playback and Loop Regions (START/END)(P.44)”.
2. Press the [VALUE] knob.

A menu appears.



3. Use the [VALUE] knob to select the item, and press the [VALUE] knob.

The sample is processed.

Item	Action
TRUNCATE	Trims (deletes) the sample's audio regions before the start point and after the end point.
NORMALIZE	Increases the overall volume.
EMPHASIS	Increases the high-frequency sound.
CANCEL	Closes the menu screen.

Marking and Splitting Samples (MARK)

You can split a sample up into multiple smaller samples. To split a sample, you must first mark the locations where the sample is to be split using markers.

Here we explain about the different ways to add markers.

Adding a marker at the desired location

You can choose where to place a marker (the location where the sample is to be split) while looking at the sample's waveform.

1. Press pads [1]–[16] to select the sample to which you want to add markers.
2. Hold down the [SHIFT] button and press the [START/END] button.

The marker setting screen appears.

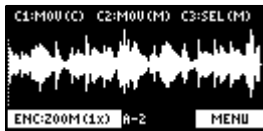

3. Decide on where to add the marker by using the [CTRL 1] knob, and then press the [MARK] button.

This adds the marker to the sample.

You can use the following controllers when the edit screen is shown.

Controller	Operation
[CTRL 1] knob	Moves the cursor (the location where a marker is placed).
[SHIFT] button + [CTRL 1] knob	Zooms the area around the cursor in/out.
[CTRL 2] knob	Moves the marker that you selected using the [CTRL 3] knob.
[SHIFT] button + [CTRL 2] knob	Zooms the area in/out around the marker selected using the [CTRL 3] knob.
[CTRL 3] knob	Selects the marker to operate.
[MARK] button	Adds a marker at the cursor location.
[DEL] button	Deletes the marker that you selected using the [CTRL 3] knob.
[RESAMPLE] button	Moves the cursor to the zero cross-point (*) that's closest to the cursor time (SNAP to Zero-Cross function). This function is enabled when the [RESAMPLE] button is lit.

* The "zero cross-point" is the time at which the value of the sample waveform crosses from zero into a positive or negative number.

The diagram shows a sine wave on a coordinate system with a vertical axis labeled '+', '0', and '-'. The horizontal axis represents time. Several red circles are placed at the points where the wave crosses the zero line. An arrow points to one of these circles with the label 'Zero-cross point'.

You can press pads [1]–[16] to preview the audio at the corresponding marker.

Adding markers while previewing a sample

You can choose where to place a marker (the location where the sample is to be split) while previewing (listening to) the sample.

1. Press pads [1]–[16] to select the sample to which you want to add markers.
2. Hold down the [SHIFT] button and press the [START/END] button.

The marker settings screen appears.

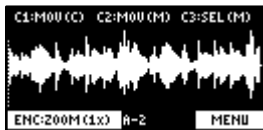

3. Press the pad [1].

The sample plays back.

4. **Press the pads [2]–[16] that are blinking blue, at the timing where you want to add a marker.**

This adds the marker to the sample. You can press pads [1]–[16] to preview the audio at the corresponding marker.

Automatically adding markers based on conditions (AUTO MARK function)

You can use the AUTO MARK function to automatically add markers based on certain conditions you specify.

1. **Press pads [1]–[16] to select the sample to which you want to add markers.**
2. **Hold down the [SHIFT] button and press the [START/END] button.**

The marker setting screen appears.

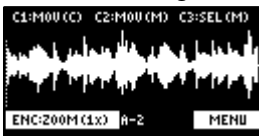

3. **Press the [VALUE] knob.**

A menu appears.

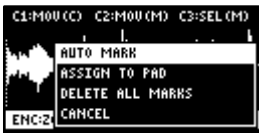

4. **Use the [VALUE] knob to select "AUTO MARK", and press the [VALUE] knob.**

The AUTO MARK setting screen appears.



5. **Use the [VALUE] knob or [CTRL 2] knob to select a parameter.**

Parameter	Value	Explanation
TIME DIVISION	2–16	Adds markers by dividing up the sample equally.
LEVEL	1–10	Adds a marker at the location in the sample where the levels exceed a certain value.
TRANSIENT	HARD, MID, SOFT	Adds a marker at the location in the sample where there is a large change in volume, such as when a sound with sharp attack plays.

6. **Use the [CTRL 3] knob to edit the setting value, and press the [VALUE] knob.**

A confirmation message appears.

7. **Use the [VALUE] knob to select "OK", and press the [VALUE] knob.**

The sample is split according to the specified conditions. You can press pads [1]–[16] to preview the audio at the corresponding marker.

Deleting all markers from a sample

You can delete all the markers at once that are used on a sample.

1. **From the sample edit screen, press the [VALUE] knob.**

A menu appears.

2. **Use the [VALUE] knob to select "DELETE ALL MARKERS", and press the [VALUE] knob.**

The markers are now deleted.

MEMO

All markers are deleted, even if you exit the sample edit screen.

Using a Marker to Split and Assign a Sample to a Pad (CHOP)

Splits the sample at the marker positions, and assigns the resulting samples to separate pads.

1. Follow the steps in “Marking and Splitting Samples (MARK)(P.46)” to add a marker where you want to split the sample.
2. Press the [VALUE] knob.

A menu appears.

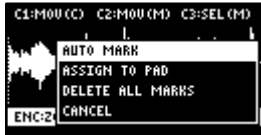

3. Use the [VALUE] knob to select “ASSIGN TO PAD”, and press the [VALUE] knob.

The assign screen appears.



4. Set the parameters.

Controller	Explanation
Pads [1]–[16]	<p>Selects the pads [1]–[16] to which you want to assign the split samples.</p> <ul style="list-style-type: none"> • The empty pads to which samples haven’t been assigned blink yellow. When you press the empty pad to which you want to assign the sample, it lights up green. • Pads to which samples have already been assigned light up dark orange. If you press a pad for which a sample is already assigned, the pad lights up red. The assigned sample is then overwritten.
[CTRL 2] knob	Selects the marker where the sample is to be split.
[CTRL 3] knob	Turns the GATE on/off.
Turn the [VALUE] knob	Arranges the split samples in order, with the first pad number being the one you selected using the [VALUE] knob. Press the [MARK] button to confirm the arrangement.
[MARK] button	<ul style="list-style-type: none"> • This operation only confirms the pads to which the samples are to be assigned, without actually assigning the samples. To assign a sample to a pad, you must press the [VALUE] knob last. • Before pressing the [MARK] button, you can switch the pad bank and change the pad bank to which the sample is assigned.
[DEL] button	Cancels the assignment of the sample you selected with the [CTRL 2] knob.

5. Press the [VALUE] knob.

The split samples are assigned to the pads.

Making Fade-in/Fade-out Settings (ENVELOPE)

This shows how to set the changes in volume when playing back a sample.

You can use fade-in settings (making the volume gradually get louder) and fade-out settings (making the volume gradually get softer).

1. Hold down the [SHIFT] button and press the [PITCH/SPEED] button.

The envelope settings screen appears.

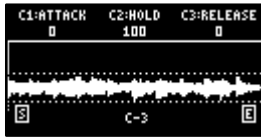

2. Press pads [1]–[16] to select the sample you want to edit.

MEMO

Press pads [1]–[16] while holding down the [MARK] button to select a sample without playing it back.

3. Use the [CTRL 1]–[CTRL 3] knobs to set the fade-in and fade-out.

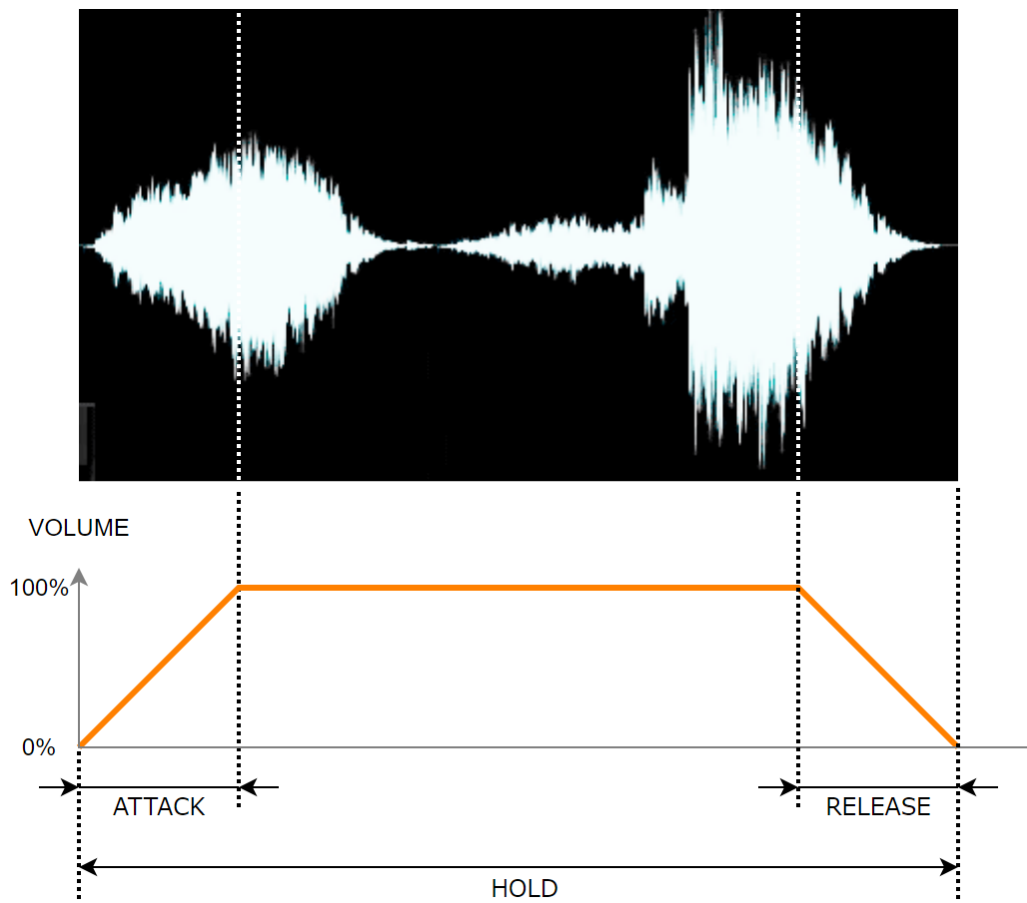

Controller	Parameter	Value	Explanation
[CTRL 1] knob	ATTACK	0–127	Sets the fade-in time. When you set this to 127, the fade-in time is three seconds.
[CTRL 2] knob	HOLD	1–100 (%)	Sets the sample playback range. The playback range is a ratio of how much of the sample is played back in respect to its total length (considered to be 100). When this is set to 50, the sample plays back from the beginning to the middle, and fade-in and fade-out are applied within this range.
[CTRL 3] knob	RELEASE	0–127	Sets the fade-out time. When you set this to 127, the fade-out time is three seconds.

MEMO

When you change the following parameters while holding down the [COPY] button, you can change the parameters of other samples registered to the same mute group simultaneously.

When you change the following parameters while holding down the [REMAIN] button, you can change the parameters of other samples registered to the same bank simultaneously.

- ATTACK
- HOLD
- RELEASE
- BPM SYNC
- GATE
- LOOP
- REVERSE

For details on the mute group settings, refer to “Preventing Samples from Playing Back at the Same Time (MUTE GROUP)(P.26)”.

Example settings for ATTACK, HOLD and RELEASE

Here are some examples of how the volume of a eight-second sample changes when you set different ATTACK, HOLD and RELEASE values.

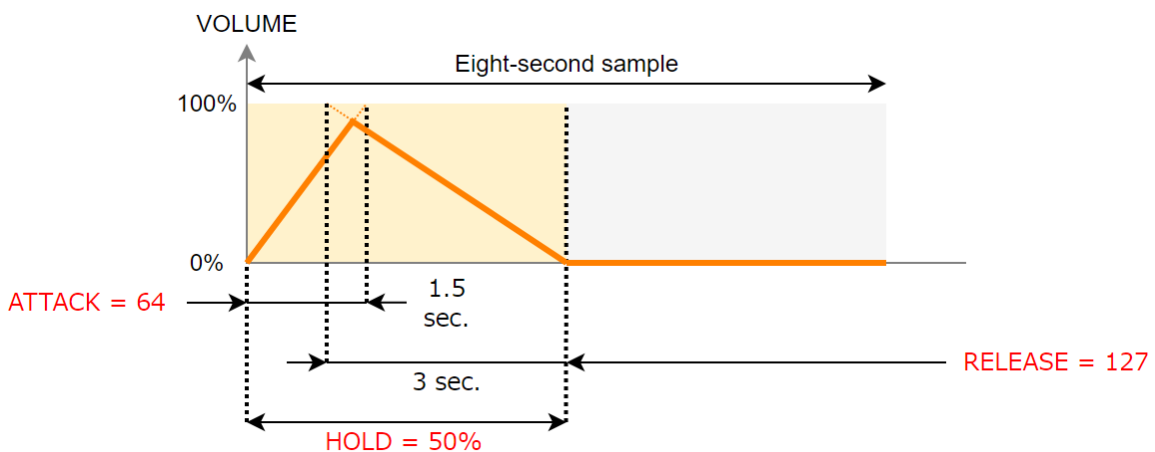
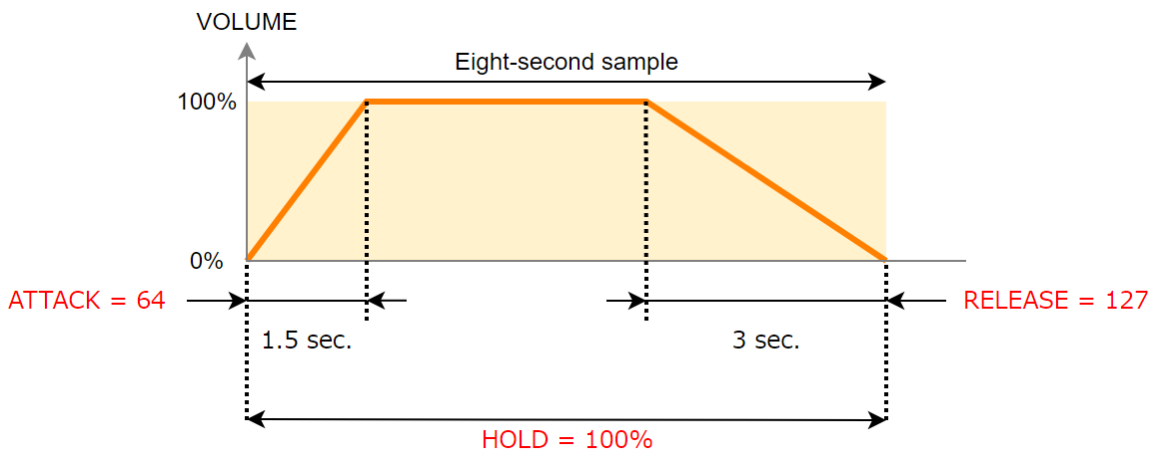
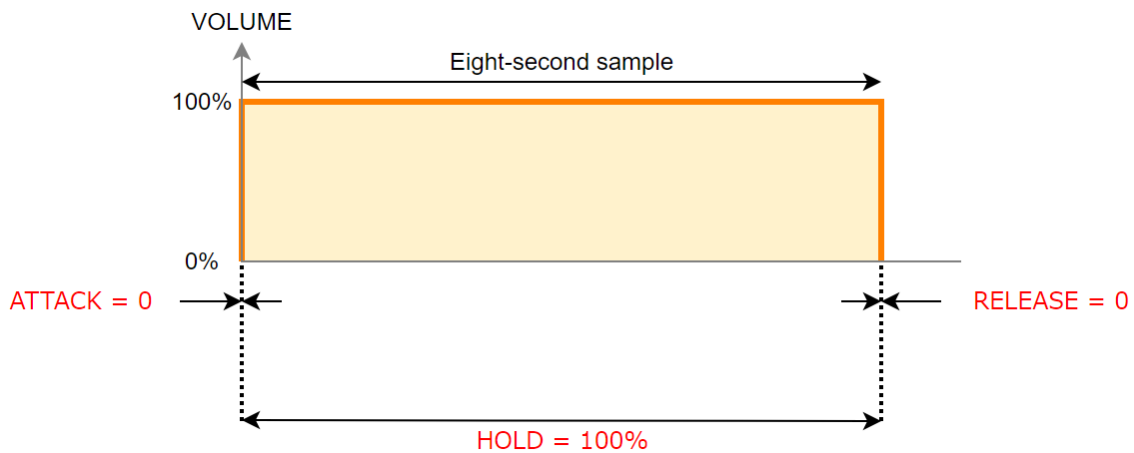

MEMO

For samples with the [GATE] button turned on (->Playing Back Only While a Pad is Pressed (GATE)(P.15)), if you release your finger from the pad while the sample is playing back, the fade-out begins at that timing.

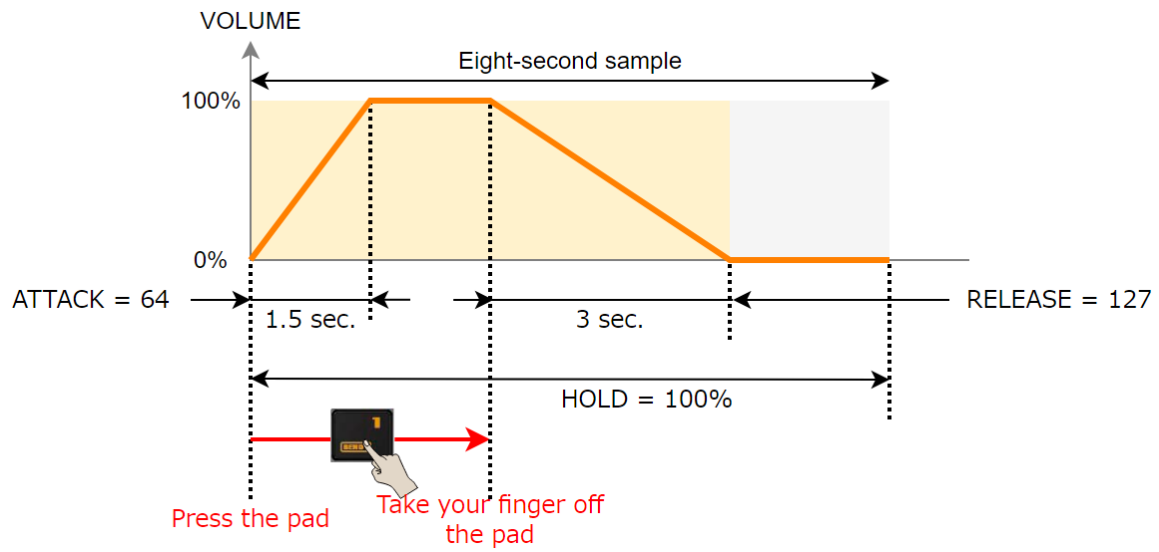

Changing the Pitch or Playback Speed of a Sample (PITCH/SPEED)

Here’s how to change the pitch (key) or playback speed of a sample. You can independently edit the pitch and playback speed, or make a sample’s length match that of the tempo.

1. Press the [PITCH/SPEED] button.

The pitch/speed settings screen appears.



2. Press pads [1]–[16] to select the sample you want to edit.

3. Use the [CTRL 1]–[CTRL 3] knobs to edit the parameters.

Controller	Parameter	Value	Explanation
[CTRL 1] knob	SPEED	50–150 (%)	Sets the playback speed. <ul style="list-style-type: none"> Use the [CTRL 1] knob while holding down the [SHIFT] button to set more precise values. This can only be set when BPM SYNC is off.
[CTRL 2] knob	PITCH	-12.00–+12.00 (when VINYL MODE is “No”) -12.00–+7.00 (when VINYL MODE is “Yes”)	Sets the playback pitch.
[SHIFT] button + [CTRL 2] knob	FINE	-1.00–+1.00 (CENT) (when VINYL MODE is “No”) -0.49–+0.50 (CENT) (when VINYL MODE is “Yes”)	Lets you set a more precise value for the playback pitch.
[CTRL 3] knob	VOLUME	0–127	Sets the sample volume.
[SHIFT] button + [CTRL 3] knob	PAN	MONO (Left), L:50–R:50, MONO (Right)	Sets the stereo position (pan) of the sample.
Turn the [VALUE] knob	BPM SET	AUTO, MANU, MANU-F	Sets the sample tempo. When this is set to AUTO, the tempo detected in AUTO mode is set. When this is set to MANU or MANU-F, you can manually set the tempo. For details, refer to “ Setting the Tempo Data in a Sample(P.83) ”.
Hold down [SHIFT] button + turn [VALUE] knob	VINYL MODE		Turns VINYL mode on/off. By using VARI mode, you can improve unnatural sound quality problems that occur when changing a sample’s pitch or speed. VARI mode is enabled when VINYL mode is set to “No”.
		No	Independently controls the playback speed and pitch.
	Yes	Changes the playback speed and pitch at the same time, like an analog record.	
	VARI MODE	Off	VARI mode is not used.
		Backing	Processes the sound as appropriate for musical instruments whose sounds have a noticeable decay. This is particularly suitable for sounds that have a pronounced attack such as drums, percussion, guitar strumming and so on.
		Ensemble	Processes the sound as appropriate for musical instruments that have a sustaining sound. This is particularly suitable for sound sources and instruments that produce long tones with smooth changes in tone, like choral groups and strings.
			<p>MEMO</p> <p>When this is set to “Ensemble”, the sample plays back with twice as many voices. For stereo samples: four times as many voices For mono samples: twice as many voices</p>

Controller	Parameter	Value	Explanation
[SHIFT] button + Pad [1]	FIXED	Vel	FIXED VELOCITY turns off.
	VELOCITY	Fix	FIXED VELOCITY turns on. Plays back with a fixed sample velocity of 127 (the maximum).

MEMO

When you change the following parameters while holding down the [COPY] button, you can change the parameters of other samples registered to the same mute group simultaneously.

When you change the following parameters while holding down the [REMAIN] button, you can change the parameters of other samples registered to the same bank simultaneously.

- SPEED
- PITCH
- VOLUME
- PAN
- BPM
- BPM SYNC
- GATE
- LOOP
- REVERSE

For details on the mute group settings, refer to “[Preventing Samples from Playing Back at the Same Time \(MUTE GROUP\)\(P.26\)](#)”.

Displaying Parameters Set in a Sample

Hold down the [REMAIN] button to show the sample parameters assigned to the currently selected pad.

When a sample is playing back, this shows the remaining playback time.

STORAGE AVAILABLE	14.23GB
NAME	B-1
Remaining Time	-00:11
STEREO/MONO	STEREO
ORIGINAL BPM	B1.0
PAD LINK	off

Initializing the Sample Parameters (INIT PARAM)

This restores the parameters set in a sample (such as the start point, end point, tempo and so on) to their default values.

1. **Hold down the [SHIFT] button and press the pad [6].**

A confirmation message appears.

If you decide to cancel, press the [EXIT] button.

2. **Use the [VALUE] knob to select "OK", and press the [VALUE] knob.**

The parameters are now initialized.

Organizing the Samples

This section explains the functions for making effective use of the samples.

Exchanging (Swapping) Samples Between Pads

Here's how to exchange (swap) the samples that are assigned to two different pads.

1. **Hold down the [SHIFT] button and press the pad [5].**

The EXCHANGE PAD screen appears.



2. **Press the two pads for which you want to exchange the samples.**

To cancel exchanging, press the [EXIT] button.

MEMO

- To exchange a sample with a sample in a different bank, first use the bank [A/F]–[E/J] buttons to select the bank before pressing the sample (pad) you want to exchange.
- You may notice a difference in volume when exchanging samples between different banks, due to the differences in the BANK VOLUME parameters set for each bank.

3. **Press the [VALUE] knob or [COPY] button.**

The samples for the pads are now exchanged.

Copying the Sample from a Pad

Here's how to copy the sample that's assigned to a pad to a different pad.

1. **Press the [COPY] button.**

The COPY PAD screen appears.



2. **Press the sample (pad) you want to copy, and then the copy destination sample (pad).**



If you decide to cancel copying, press the [EXIT] button.

MEMO

- To copy a sample to a different bank, first use the bank [A/F]–[E/J] buttons to select the bank before pressing the sample (pad) for the copy destination.
- To copy a sample to a different project, first use the [CTRL 3] knob to select the project before pressing the sample (pad) for the copy destination.
- You may notice a difference in volume when copying samples between different banks or projects, due to the differences in the BANK VOLUME parameters set for each bank.

3. **Press the [VALUE] knob or [COPY] button.**

The pad's sample is copied.

NOTE

Performing this operation overwrites (erases) the sample in the copy destination pad.

Copying all samples in a bank to another bank

This is how to copy all the samples in a bank to another bank.

1. **Hold down the [COPY] button and press the [EXIT] button.**

The COPY BANK PAD screen appears.



2. **Press the bank [A/F]–[E/J] buttons to select the bank to copy (source).**
3. **Turn the [VALUE] knob clockwise to move the cursor.**
4. **Press the bank [A/F]–[E/J] buttons to select where to copy the bank (destination).**



MEMO

You can use the [CTRL 3] knob to select a project, when copying samples to a different project.

5. **Press the [VALUE] knob.**

All the samples in the bank are copied to the specified bank.

NOTE

Performing this operation overwrites (erases) the sample in the copy destination pad.

Protecting a Sample (PROTECT)

This function prevents the samples and patterns assigned to a pad from being overwritten by being copied or edited, or accidentally deleted.

Protection is set on a bank by bank basis. Protection is set for both samples and patterns.

1. **Press the bank [A/F]–[E/J] buttons to select the banks to protect.**

To select banks F–J, press the bank [A/F]–[E/J] buttons twice to make them blink.

2. **Hold down the [SHIFT] button and press the [COPY] button.**

A protect confirmation message appears.

To cancel the protect operation, press the [EXIT] button.

3. **Use the [VALUE] knob to select "OK", and press the [VALUE] knob.**

MEMO

To cancel protection, do the same operation again.

Deleting the Sample from a Pad

This is how to delete the sample assigned to a pad.

1. **Press the [DEL] button.**

The SELECT PAD screen appears.



2. **Press the pad containing the sample you want to delete.**

If you decide to cancel deleting, press the [EXIT] button.

3. Press the [VALUE] knob or [DEL] button.

The pad's sample is deleted.

NOTE

You can't restore a pad's sample after it has been deleted.

If you want to keep your data or make sure it doesn't get accidentally modified, we recommend that you follow the steps in "Backing up Your Data (BACKUP)(P.120)" to create regular backups.

Deleting all samples in a bank at once

1. Hold down the [DEL] button and press the [EXIT] button.

The bank deletion screen appears.



2. Press the bank [A/F]–[E/J] buttons.

Select a bank to delete.

3. Press the [VALUE] knob or [DEL] button.

The samples in the selected bank are deleted.

NOTE

You can't restore a pad's sample after it has been deleted.

If you want to keep your data or make sure it doesn't get accidentally modified, we recommend that you follow the steps in "Backing up Your Data (BACKUP)(P.120)" to create regular backups.

Combining Samples to Create a Pattern (PATTERN SEQUENCER)

You can record the order in which the samples play back, so that multiple samples play back at the timing you choose. The data in which the playback order is recorded is called a “pattern”.

In this section, we explain how the patterns are played back and how to create (record) them.

Playing a Pattern

This shows you how to recall a pattern, which contains the sample playback order, and play it back.

1. Press the [PATTERN SELECT] button.

The SELECT screen appears.

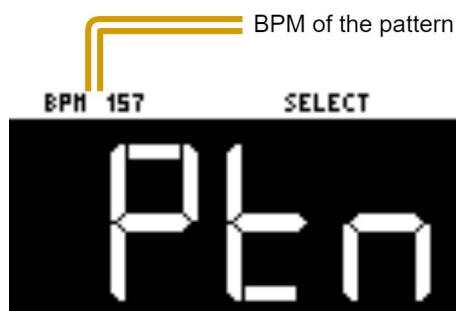

Pads to which patterns are assigned light up purple.

2. Press pads [1]–[16].

This plays back the pattern.

When you press the other pads [1]–[16] while the pattern is playing back, this places the next pattern to play back in standby. When the currently playing pattern has finished playing, the next pattern starts playing.

To stop the pattern playback, press the pad that’s playing back (pads [1]–[16]; lit white) or press the [EXIT] button.

MEMO

- If you hold down the [SUB PAD] button and press a [1]–[16] pad, the pattern will change immediately.
- Press pads [1]–[16] while holding down the [VALUE] knob to select a pattern (the pattern does not play back at this time).
- You can press the [REC] button while a pattern is playing back to switch to real-time pattern recording. Note that recording starts at the top of the first measure of the pattern. If you’ve pressed the [REC] button while the pattern is playing, the message “Wait for REC” appears.
- You can switch to pattern TR-REC by pressing the [REC] button while holding down the [SHIFT] button during pattern playback.

Creating a New Pattern (Real-time Recording)

Here's how to create a pattern by recording what you play on the keyboard and how you operate the controllers, just as-is.

1. Press the [PATTERN SELECT] button.
2. Press the [REC] button.

Empty pads in which no patterns have been recorded blink red.



MEMO

The metronome sounds when the "Metronome:PTN" parameter is "ON", which is the SYSTEM parameter "CLICK(P.124)". Press pad [9] while holding down the [SHIFT] button to turn the metronome sound on/off.

3. Press pads [1]–[16] that are blinking red to select the record destination pattern.

The unit enters pattern record standby mode, and the RECORD SETTING screen appears.



4. Configure the parameters for the pattern.

Controller	Parameter	Value	Explanation
[CTRL 1] knob	BPM	40–200	Sets the pattern's tempo.
[CTRL 2] knob	LENGTH	1–64 (measures)	Sets the length of the pattern.
[CTRL 3] knob	STRENGTH	0–100(%)	Sets the strength of quantization used for adjusting the note timing, as set in the QTZ parameter. When you set this to 100%, the notes are adjusted exactly according to the timing set in the QTZ parameter.
	SHFL RATE	-50–+50	You can set how much to slide the timing of the upbeats (the strength of the shuffle feel). A setting of "0" results in no shuffle. Settings in the range of +10–16 generally give a pleasant shuffle feel. This is enabled when the QTZ parameter is set to "SHUFFLE 16" or "SHUFFLE 8".
[SHIFT] button + [CTRL 2] knob	TIME SIGN	1/4–7/4	Specifies the time signature.
[SHIFT] button + [CTRL 3] knob	METRO VOL	0–5	Sets the volume of the metronome.
[VALUE] knob	QTZ (QUANTIZE)	Off, GRID 32, GRID 16.3, GRID 16, GRID 8.3, GRID 8, GRID 4.3, GRID 4, SHUFFLE 16, SHUFFLE 8	When the player presses a pad to play back a sample, the timing inevitably varies. Quantization is a function that automatically corrects these inconsistencies in timing when you record a pattern. When quantization is set, you can record patterns in which the notes sound within specified intervals.
[REMAIN] button	REC MODE	Real-Time	Records in real time. The [REMAIN] button lights up at this time.
		TR-REC	Records using TR-REC. The [REMAIN] button blinks at this time.

5. Press the [REC] button.

The pattern is recorded. The pattern repeatedly records at the length specified in the LENGTH parameter (loop recording). You can record and overdub different and multiple samples, without overwriting the pattern.

MEMO

- While you're recording a pattern, the unit switches between rehearsal and recording mode each time you press the [REC] button. When in rehearsal mode, loop playback continues for the recorded pattern without being recorded. This function is useful when you want to practice recording a pattern.

- You can press the [REC] button while a pattern is playing back to switch to pattern recording. Note that recording starts at the beginning of the pattern. If you've pressed the [REC] button in the middle of the pattern, the message "Wait for REC" appears.
- While the pattern is recording, press the [PATTERN SELECT] button while holding down the [SHIFT] button to undo the data you just inputted (recorded). This is useful when you made a mistake in timing when recording a pattern.
- If you press the [RECORD SETTING] button while the pattern is recording or during rehearsal mode, the RECORD SETTING screen is shown. Note that you can't set the LENGTH parameter at this time. Set the LENGTH parameter before recording a pattern. Press the [EXIT] button to return to the previous screen.
- Press the [DEL] button while recording a pattern to enter erase mode (which lets erase a pattern). The performance data recorded in the pattern for the pads (samples) [1]–[16] is erased, during the time range that you hold them down. Press the [DEL] button again to return to the previous screen.
- You can also record note messages that are input via the MIDI IN connector and the USB port to a pattern.

6. When you are finished recording the pattern, press the [EXIT] button twice.

Press the [EXIT] button once to finish recording. The recorded pattern is automatically saved to the pad. Press twice to stop pattern playback.

Adding a Count-in Before Recording a Pattern

This feature adds a count-in before the pattern start recording. This gives you time to get ready to play before the pattern actually begins recording.

1. Hold down the [SHIFT] button and press the pad [10].

Edit the count-in setting.

Value	Explanation
COUNTIN 1MEAS	Adds a one-measure count-in before recording.
COUNTIN 2MEAS	Adds a two-measure count-in before recording.
COUNTIN WAIT	Recording starts along with sample playback.
COUNTIN OFF	No count-in is used. Press the [REC] button to immediately begin recording.

The value changes in order each time you press pad [10] while holding down the [SHIFT] button.

Creating a New Pattern (TR-REC)

Here's how to create a pattern by setting the sample playback timing at the position you like on the steps.

This method of recording is suitable for creating drum patterns.

1. Press the [PATTERN SELECT] button.
2. Press the [REC] button.

Empty pads in which no patterns have been recorded blink red.



MEMO

The metronome sounds when the "Metronome:PTN" parameter is "ON" (the SYSTEM parameter "CLICK(P.124)"). Press pad [9] while holding down the [SHIFT] button to turn the metronome sound on/off.

3. Press pads [1]–[16] that are blinking red to select the record destination pattern.

The unit enters pattern record standby mode, and the RECORD SETTING screen appears.



4. Press the [REMAIN] button.

The pattern recording method switches to "TR-REC".



5. Set the parameters for the pattern.

Controller	Parameter	Value	Explanation			
[CTRL 1] knob	BPM	40–200	Sets the pattern's tempo.			
[CTRL 2] knob	LENGTH	1–64 (measures)	Sets the length of the pattern.			
[CTRL 3] knob	SHFL RATE	-50+50	You can set how much to slide the timing of the upbeat (the strength of the shuffle feel). A setting of "0" results in no shuffle. Settings in the range of +10–16 generally give a pleasant shuffle feel.			
[SHIFT] button + [CTRL 2] knob	TIME SIGN	1/4–7/4	Specifies the time signature.			
[SHIFT] button + [CTRL 3] knob	METRO VOL	0–5	Sets the volume of the metronome.			
[REMAIN] button	REC MODE	<table border="0"> <tr> <td>Real-Time</td> <td>Records in real time. The [REMAIN] button lights up at this time.</td> </tr> <tr> <td>TR-REC</td> <td>Records using TR-REC. The [REMAIN] button blinks at this time.</td> </tr> </table>	Real-Time	Records in real time. The [REMAIN] button lights up at this time.	TR-REC	Records using TR-REC. The [REMAIN] button blinks at this time.
Real-Time	Records in real time. The [REMAIN] button lights up at this time.					
TR-REC	Records using TR-REC. The [REMAIN] button blinks at this time.					

6. Press the [REC] button.

TR-REC pattern recording begins.



7. Press pads [1]–[16] while holding down the [SUB PAD] button to select the sample.
8. Set the parameters for the sample to input.

Controller	Parameter	Value	Explanation																																																		
[CTRL 1] knob	SUBSTEP		You can split up the steps into multiple and separate units (sub steps). You can also configure how the split sub steps are played. * This is enabled when MODE is "TRIG".																																																		
			<table border="1"> <thead> <tr> <th>Value</th> <th>Pattern</th> </tr> </thead> <tbody> <tr> <td>1</td> <td>ON</td> </tr> <tr> <td>2</td> <td>ON ON</td> </tr> <tr> <td rowspan="7">3</td> <td>a</td> <td>ON ON ON</td> </tr> <tr> <td>b</td> <td>ON</td> </tr> <tr> <td>c</td> <td>ON</td> </tr> <tr> <td>d</td> <td>ON</td> </tr> <tr> <td>e</td> <td>ON ON</td> </tr> <tr> <td>f</td> <td>ON ON</td> </tr> <tr> <td>g</td> <td>ON ON</td> </tr> <tr> <td rowspan="15">4</td> <td>a</td> <td>ON ON ON ON</td> </tr> <tr> <td>b</td> <td>ON</td> </tr> <tr> <td>c</td> <td>ON</td> </tr> <tr> <td>d</td> <td>ON</td> </tr> <tr> <td>e</td> <td>ON</td> </tr> <tr> <td>f</td> <td>ON ON</td> </tr> <tr> <td>g</td> <td>ON ON</td> </tr> <tr> <td>h</td> <td>ON ON</td> </tr> <tr> <td>i</td> <td>ON ON ON</td> </tr> <tr> <td>j</td> <td>ON ON ON</td> </tr> <tr> <td>k</td> <td>ON ON ON</td> </tr> <tr> <td>l</td> <td>ON ON ON</td> </tr> <tr> <td>m</td> <td>ON ON</td> </tr> <tr> <td>n</td> <td>ON ON</td> </tr> <tr> <td>o</td> <td>ON ON</td> </tr> </tbody> </table>	Value	Pattern	1	ON	2	ON ON	3	a	ON ON ON	b	ON	c	ON	d	ON	e	ON ON	f	ON ON	g	ON ON	4	a	ON ON ON ON	b	ON	c	ON	d	ON	e	ON	f	ON ON	g	ON ON	h	ON ON	i	ON ON ON	j	ON ON ON	k	ON ON ON	l	ON ON ON	m	ON ON	n	ON ON
Value	Pattern																																																				
1	ON																																																				
2	ON ON																																																				
3	a	ON ON ON																																																			
	b	ON																																																			
	c	ON																																																			
	d	ON																																																			
	e	ON ON																																																			
	f	ON ON																																																			
	g	ON ON																																																			
4	a	ON ON ON ON																																																			
	b	ON																																																			
	c	ON																																																			
	d	ON																																																			
	e	ON																																																			
	f	ON ON																																																			
	g	ON ON																																																			
	h	ON ON																																																			
	i	ON ON ON																																																			
	j	ON ON ON																																																			
	k	ON ON ON																																																			
	l	ON ON ON																																																			
	m	ON ON																																																			
	n	ON ON																																																			
	o	ON ON																																																			
	HOLD STEP	1-32, LAST	Sets the step length used for sample playback. * This is enabled when MODE is "HOLD STEP".																																																		
[CTRL 2] knob	PITCH	-12-+12	Sets the sample pitch.																																																		
[PITCH/SPEED] button		CHROMATIC	Set and input the sample's pitch for each step in this mode. Each step that's input can be played back at a different pitch. You can press the [VALUE] knob in this mode to select the scale. Hold down and turn the [VALUE] knob to select a note from the scale.																																																		
		PAD	The sample's pitch is input as a fixed pitch in this mode. With this setting, all of the steps you input play back at the pitch you set in PITCH.																																																		
[CTRL 3] knob	VELOCITY	0-127	Specifies the dynamics (velocity) of the sample.																																																		
[SHIFT] button + [CTRL 1] knob	BPM	40-200	Sets the pattern's tempo.																																																		
[SHIFT] button + [CTRL 2] knob	SHUFFLE	-50-+50	You can set how much to slide the timing of the upbeats (the strength of the shuffle feel). A setting of "0" results in no shuffle. Settings in the range of +10-16 generally give a pleasant shuffle feel.																																																		
[SHIFT] button + [CTRL 3] knob	START	-50-99 (%)	Sets the timing at which the sample starts playing back. If this is set to a value other than 0%, sub steps cannot be set.																																																		
[REMAIN] button	MODE		This selects the input mode for TR-REC.																																																		
	TRIG		The sample plays in each step.																																																		
	HOLD STEP		The steps play back joined at the length specified by the [CTRL 1] knob. Joining two steps gives the same results as using a tie. When MODE is set to "HOLD STEP", the GATE parameter for the sample is automatically set to "ON".																																																		
[HOLD] button	-	-	Plays back only the selected pad.																																																		

9. Press pads [1]-[16] to select the step (timing) at which the sample plays back.

The sample is placed (input) into the step you selected using pads [1]-[16].

The pads light up corresponding to the steps that sound.

Press pads [1]-[16] to turn off the pads corresponding to the steps you don't want to sound.

10. To input patterns from measure 2 onward, use the [VALUE] knob to select the measure (bar).



11. When you are finished recording the pattern, press the [EXIT] button twice.

Press the [EXIT] button once to finish recording. The recorded pattern is automatically saved to the pad. Press twice to stop pattern playback.

Functions you can use during TR-REC input

You can use the controllers in combination during TR-REC input to perform the following operations.

Controller	Explanation
[DEL] button + [A/F] button	Deletes the notes (for one measure) corresponding to the selected pad.
[DEL] button + [B/G] button	Deletes the notes (for one measure) corresponding to all pads.
[ROLL] button + [CTRL 1] knob	You can record the motion of [CTRL 1] knob in the steps. * This is enabled when MODE is "TRIG".
[ROLL] button + [CTRL 2] knob	You can record the motion of [CTRL 2] knob in the steps. * This is enabled when MODE is "TRIG".
[ROLL] button + [CTRL 3] knob	You can record the motion of [CTRL 3] knob in the steps. * This is enabled when MODE is "TRIG".
[VALUE] knob + [SUB PAD] button + pads [1]–[16]	You can select samples without playing them back.

MEMO

- If you press the [RECORD SETTING] button while the pattern is recording, the RECORD SETTING screen is shown. Note that you can't set the LENGTH or TIME SIGN parameters at this time. These parameters need to be edited before you record the pattern.
- Press the [EXIT] button to return to the previous screen.
- You can switch to pattern TR-REC by pressing the [REC] button while holding down the [SHIFT] button during pattern playback.

Converting Patterns to Samples

Here's how to convert a performance that's recorded in a pattern into a sample.

There are two ways to convert performance data to a sample, each with their own characteristics.

Differences between bouncing and resampling

Type	How each type works differently
Bouncing	Converts the entire selected pattern into a sample. No sound is heard while the sample is being converted. The pattern is converted into a sample without applying effects. → "Converting Patterns to Samples(P.65)"
Resampling	The selected pattern plays back once it is converted into a sample. You can stop the conversion at a point you like while listening to the sound. With resampling, you can convert the pattern with effects applied. → "Sampling a Pattern (RESAMPLE)(P.65)"

Sampling a Pattern (RESAMPLE)

You can sample the performance you recorded to a pattern as-is, and turn it into a sample.

1. Press the [PATTERN SELECT] button.
2. Press the [RESAMPLE] button.



MEMO

The metronome sounds when the "Metronome:REC" parameter is "ON" (the SYSTEM parameter "CLICK(P.124)"). Press pad [9] while holding down the [SHIFT] button to turn the metronome sound on/off.

3. Press the [RECORD SETTING] button.

The input settings screen appears.



4. Use the [CTRL 2] knob to set ROUTING to "Mix."

MEMO

When ROUTING is set to "ExtIn," only the audio input from an external device is sampled (the sample's audio is not included in the resample). You can sample your performance while playing back samples as backing sounds.

5. Press the [EXIT] button.
6. Press the pads [1]–[16] that are blinking red.

Empty pads to which samples haven't been assigned blink red.

When you press an empty pad, the message "Press Pad to START" is shown. Pads that contain a recorded pattern blink in blue.



7. Press pads [1]–[16] to select a pattern.

Sampling begins when the pattern starts playing back.



If you decide to cancel sampling, press the [EXIT] button.

8. To exit sampling, press the [REC] button again.

“Bouncing” is another method you can use to convert a pattern into a sample.

For details, refer to “[Converting Patterns to Samples \(BOUNCE\)](#)(P.66).”

Converting Patterns to Samples (BOUNCE)

Here’s how to convert a pattern that’s assigned to a pad into a sample, and then assign that sample to a pad.

1. Follow the steps in “[Copying the Pattern of a Pad\(P.78\)](#)” to select the pattern you want to convert.



2. Press the [PATTERN SELECT] button.



If a sample is already saved to a pad, the pad lights up dimly in blue. Empty pads blink blue.

3. Press the pad where you want to save the converted sample.



If you decide to cancel the conversion to a sample, press the [EXIT] button.

MEMO

If you use the bank [A/F]–[E/J] buttons to select the bank before pressing the save destination pad, you can assign the sample to a pad in a different bank.

Also, you can use the [CTRL 3] knob to select a project, when assigning the sample to a pad belonging to a different project.

4. Press the [VALUE] knob or [COPY] button.

The pattern is converted to a sample and assigned to the specified pad.

NOTE

This overwrites (erases) the sample in the save destination pad.

MEMO

When a pattern is converted into a sample, the effect (BUS 1–4) is automatically turned off (bypassed). Converting data for longer patterns into samples may take some time.

You can also use resampling to convert patterns into samples.

For details, refer to “[Sampling a Pattern \(RESAMPLE\)](#)(P.65).”

Selecting a Pattern Bank

Select the bank to use from the 10 available banks (A–J).

- 1. Press the bank [A/F]–[E/J] buttons.**

The bank switches.

Each time you press the bank [A/F] button, the bank switches between A and F.

When bank A–E is selected, the bank [A/F]–[E/J] button lights up. When bank F–J is selected, the bank [A/F]–[E/J] button blinks.

Playing Back Patterns in Order (PATTERN CHAIN)

Pattern chain is a function that lets you play back patterns you’ve created with the pattern sequencer, in a specified order. You can record and play back up to 16 patterns with a single pattern chain. Up to 16 pattern chains can be stored per project.

Creating a pattern chain

1. Use the pattern sequencer to create patterns beforehand (Creating a New Pattern (Real-time Recording)(P.60), Creating a New Pattern (TR-REC)(P.62)).
2. Press the [PATTERN SELECT] button.

The unit enters pattern sequencer mode.



3. While holding down the [HOLD] button, press pads [1]–[16] to select the pattern chain number (1–16) to record.

The PATTERN CHAIN screen appears.



4. Press pads [1]–[16] to select the pattern you want to record to the pattern chain.
5. When you finish recording to the pattern chain, press the [EXIT] button.

The unit returns to the PATTERN SELECT screen. and the recorded pattern chain is automatically saved.

MEMO

- You can also record patterns that are in different banks to a pattern chain. To switch between banks, press the bank [A/F]–[E/J] buttons.
- Turn the [VALUE] knob to move the cursor. You can insert a pattern at the cursor position.
- To delete the pattern at the cursor position, press the [DEL] button.
- Once you’ve edited the pattern chain, an asterisk (*) appears at the top right-hand part of the screen. If you want to revert (undo) your edits, press the [DEL] button while holding down the [SHIFT] button.



- Press the [REMAIN] button to set the pattern chain to play back repeatedly. Toggle the repeat playback setting on/off by pressing the [REMAIN] button.

Value	Explanation
REPEAT All	Plays back repeatedly from the beginning of the pattern chain to the end.
REPEAT Current	Plays the current pattern (patterns with pads that are lit up pink) back repeatedly.
REPEAT Off	Plays the pattern chain back only one time, from beginning to end. Playback does not repeat.

Playing back a pattern chain

1. Press the [PATTERN SELECT] button.

The unit enters pattern sequencer mode.



2. While holding down the [HOLD] button, press pads [1]–[16] to select the pattern chain number to play back.

The PATTERN CHAIN screen appears.



3. Press the [SUB PAD] button.

The selected pattern chain plays back.

To stop playback, press the [SUB PAD] button again.

4. To exit pattern chain, press the [EXIT] button.

The unit returns to the PATTERN SELECT screen.

Sampling the playback of a pattern chain

You can sample (resample) the audio of a pattern chain as it plays back.

1. Press the [PATTERN SELECT] button.

The unit enters pattern sequencer mode.



2. Press the [RESAMPLE] button.
3. Press the [RECORD SETTING] button.

The input settings screen appears.



4. Use the [CTRL 2] knob to set ROUTING to "Mix".
5. Press the [EXIT] button.
6. Press the pads [1]–[16] that are blinking red.

Empty pads to which samples haven't been assigned blink red.

When you press an empty pad, the pad changes to blinking purple, and a message "Press Pad to START" is shown.



7. Press pads [1]–[16] while holding down the [HOLD] button to select the pattern chain to play back.

The PATTERN CHAIN screen appears.



8. Press the [SUB PAD] button.

Sampling begins when the selected pattern chain starts playing back.
If you decide to cancel sampling, press the [EXIT] button.

MEMO

When pattern chain repeat is set to "REPEAT Off", sampling ends at the same time as pattern chain playback ends.

9. To exit sampling, press the [REC] button.

The sample is saved to the pad.

Recording Effect Operations to a Pattern (EFX MOTION REC)

Here's how to record your effect on/off and effect parameter ([CTRL 1]–[CTRL 3] knob) operations to a pattern in real time.

1. Press the [PATTERN SELECT] button.

Pads to which patterns are assigned light up purple.

2. Press pads [1]–[16] to select the pattern to which you want to record the effect operations.

This plays back the pattern.

3. Press the [REC] button.

The pattern begins recording in real time.

4. Press the [MARK] button.

The message "MOTION REC START" is shown (EFX MOTION REC).

The effect operations now begin recording.

5. Operate the effects along with the pattern performance.

Your effect operations are recorded to the pattern.

6. Once you finish recording, press the [EXIT] button.

The same effect operations you made when recording are played back along with the pattern (EFX MOTION PLAY).

MEMO

Use the [START/END] button to enable/disable playback of the effect operations you recorded.

[START/END] button	Action
Blinks	EFX MOTION PLAY is ON. The recorded effect operations are played back.
Unlit	EFX MOTION PLAY is OFF. The recorded effect operations do not play back.

Deleting Effect Operations Recorded in a Pattern (EFX MOTION ERASE)

Here's how to delete effect operations that you recorded using the steps shown in "Recording Effect Operations to a Pattern (EFX MOTION REC)(P.71)" from a pattern.

1. **Press the [PATTERN SELECT] button.**
2. **Press the [PATTERN EDIT] button.**
3. **Press pads [1]–[16] to select the pattern you want to edit.**
The pattern edit screen appears.
4. **Hold down the [DEL] button and press the [MARK] button.**
The "Operation Completed!" message appears.
The effect operations are now deleted.

Deleting Specific Effect Operations From a Pattern

This shows how to delete specific effect operations that you recorded using the steps shown in "Recording Effect Operations to a Pattern (EFX MOTION REC)(P.71)" from a pattern.

1. **Press the [PATTERN SELECT] button.**
Pads to which patterns are assigned light up purple.
2. **Press pads [1]–[16] to select the pattern from which you want to delete the effect operations.**
This plays back the pattern.
3. **Press the [REC] button.**
The pattern begins recording in real time.
4. **Listen to the pattern. When the part for which you want to delete the effect operations plays, press the [MARK] button while holding down the [SHIFT] button.**
The "MOTION ERASE ON" message appears.
This begins deleting the effect operations.
5. **When the pattern reaches the point at which you want to stop deleting the effect operations, press the [MARK] button while holding down the [SHIFT] button.**
The "MOTION ERASE OFF" message appears.
This deletes the effect operations within the range between the "MOTION ERASE ON" and "MOTION ERASE OFF" messages.
6. **When you're finished deleting, press the [EXIT] button.**

Recording Pad Mute Operations to a Pattern (PAD MUTE MOTION REC)

Here's how to record the pad mute on/off operations to a pattern in real time.

1. Press the [PATTERN SELECT] button.

Pads to which patterns are assigned light up purple.

2. Press pads [1]–[16] to select the pattern to which you want to record the pad mute operations.

This plays back the pattern.

3. Press the [REC] button.

The pattern begins recording in real time.

4. Hold down the [SHIFT] button and press the [REVERSE] and [REMAIN] buttons.

The message "PAD MUTE MODE (MOTION REC)" appears (PAD MUTE MOTION REC).

The pad mute operations now begin recording.

5. While listening to the pattern, press the pads [1]–[16] of the samples you want to mute. Press pads [1]–[16] again when you want to unmute the samples.

The pad mute operations are recorded to the pattern.

Muted samples (pads) are lit up red, and unmuted samples (pads) are lit up white.

6. Once you finish recording, press the [EXIT] button.

The pad mute operations you recorded are played back along with the pattern (PAD MUTE MOTION PLAY).

7. To exit the pad mute playback, press the [EXIT] button.

The unit now returns to playing the patterns normally.

At this time, the pad mute is not played back, but the pad mute operations are stored in memory.

Deleting Pad Mute Operations Recorded in a Pattern (PAD MUTE MOTION ERASE)

Here's how to delete pad mute operations that you recorded using the steps shown in "Recording Effect Operations to a Pattern (EFX MOTION REC)(P.71)" from a pattern.

1. **Press the [PATTERN SELECT] button.**
2. **Press the [PATTERN EDIT] button.**
3. **Press pads [1]–[16] to select the pattern you want to edit.**
The pattern edit screen appears.
4. **Hold down the [DEL] button and press the [REVERSE] button.**
The "Operation Completed!" message appears.
The pad mute operations are now deleted.

Deleting Specific Pad Mute Operations from a Pattern

This shows how to delete specific pad mute operations that you recorded using the steps shown in "Recording Pad Mute Operations to a Pattern (PAD MUTE MOTION REC)(P.73)" from a pattern.

1. **Press the [PATTERN SELECT] button.**
Pads to which patterns are assigned light up purple.
2. **Press pads [1]–[16] to select the pattern from which you want to delete the pad mute operations.**
This plays back the pattern.
3. **Press the [REC] button.**
The pattern begins recording in real time.
4. **Hold down the [SHIFT] button and press the [REVERSE] and [REMAIN] buttons.**
The message "PAD MUTE MODE (Motion REC)" appears (PAD MUTE MOTION REC).
The pad mute operations now begin recording.
5. **Press the [DEL] button.**
The message "PAD MUTE MODE (Motion ERASE)" appears (PAD MUTE MOTION ERASE).
Now you can delete the pad mute operations.
The pads light up blue.
6. **Listen to the pattern. When the part for which you want to delete the pad mute operations plays, press the pads [1]–[16] (the pads with the pad mute operations you want to delete).**
The pad mute operations recorded for that pad are deleted while you hold down the pad.
7. **When you've finished deleting, press the [DEL] button.**
The message "PAD MUTE MODE (MOTION REC)" appears.
The unit returns to recording pad mute operations (PAD MUTE MOTION REC).

Editing a Pattern (PATTERN EDIT)

You can change the length of a pattern or change the range within which it plays back.

You can also copy and chain patterns, and delete unwanted sections of a pattern.

1. Press the [PATTERN SELECT] button.
2. Press the [PATTERN EDIT] button.
3. Press pads [1]–[16] to select the pattern you want to edit.

The pattern edit screen appears.

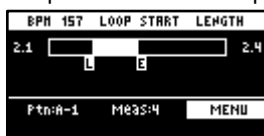

4. Use the [CTRL 1]–[CTRL 3] knobs to edit the parameters.

Controller	Parameter	Value	Explanation
[CTRL 1] knob	BPM	40–200	Sets the pattern's tempo.
[CTRL 2] knob	LOOP START	1–64 (measures)	Sets the measure at which the pattern begins playing back. <ul style="list-style-type: none"> • This is enabled when the length (number of measures) set in the LENGTH parameter is shorter than the overall pattern.
[CTRL 3] knob	LENGTH	1, 2, 4, 8, 16, 32, 64 (measures)	Sets the length of pattern playback.

MEMO

You can select patterns to delete that are within the loop range (the playback range).

Use the following operation in continuation from step 4.

1. When you hold down the [DEL] button, the pads (patterns) within the loop range light up blue.
2. While pressing the [DEL] button, press the pad (pattern) you want to delete. The selected pad (pattern) lights up bright blue.
3. While holding down the [DEL] button, press the [VALUE] knob. The selected pad (pattern) is deleted.

Copying and Connecting Patterns (DUPLICATE)

This shows how to copy a pattern and connect it to the current pattern. By doing this, the overall pattern becomes twice as long.

1. Press the [PATTERN SELECT] button.
2. Press the [PATTERN EDIT] button.
3. Press pads [1]–[16] to select the pattern you want to edit.

The pattern edit screen appears.

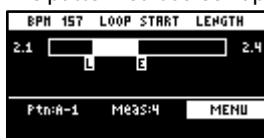

4. Press the [VALUE] knob. A menu appears.
5. Use the [VALUE] knob to select "DUPLICATE", and press the [VALUE] knob.

The pattern is copied and connected to the end of the current pattern.

Cropping Unnecessary Sections from a Pattern (CROP)

This deletes all the sections from a pattern except for the range you select.

1. Press the [PATTERN SELECT] button.

2. Press the [PATTERN EDIT] button.
3. Press pads [1]–[16] to select the pattern you want to edit.

The pattern edit screen appears.

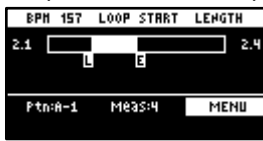

4. Set the range you want to keep within the pattern in the LOOP START and LENGTH parameters (“Editing a Pattern (PATTERN EDIT)(P.75)”).
5. Press the [VALUE] knob.

A menu appears.

6. Use the [VALUE] knob to select “CROP”, and press the [VALUE] knob.

All sections of the pattern outside of the playback range (the length selected with the LOOP START and LENGTH parameters) are deleted.

Aligning the Playback Timing of Samples Inputted to a Pattern (QUANTIZE)

You can quantize the notes of a pattern that you’ve inputted in real time.

This lets you correct patterns in which the beginning of the sample playback is out of time with the beat of the song.

1. Press the [PATTERN SELECT] button.
2. Press the [PATTERN EDIT] button.
3. Press pads [1]–[16] to select the pattern you want to quantize.

The pattern edit screen appears.

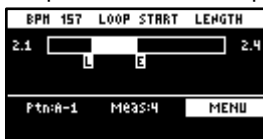

4. Press the [RECORD SETTING] button.

The quantize screen appears.



If the quantize screen isn’t shown, press the [RECORD SETTING] button once more.

5. Press pads [1]–[16] to select the samples you want to quantize.
6. Use the [CTRL 1]–[CTRL 3] knobs to configure the quantize parameters.

Controller	Parameter	Value	Explanation
[CTRL 2] knob	QTZ	GRID 32, GRID 16.3, GRID 16, GRID 8.3, GRID 8, GRID 4.3, GRID 4, SHUFFLE 16, SHUFFLE 8	Specifies the interval to which the notes should be aligned. Set this to “GRID 32” when quantizing to thirty-second note intervals, and set this to “GRID 4.3” when quantizing to quarter-note triplets. The “SHUFFLE 16” and “SHUFFLE 8” settings give the rhythm a shuffle or swing feel.
[CTRL 3] knob	STR	0–100 (%)	Sets the strength of quantization used for adjusting the note timing, as set in the QTZ parameter. If you’ve selected “GRID” for the QTZ parameter, a setting of 100% corrects the note timing to match the timing set in the QTZ parameter.

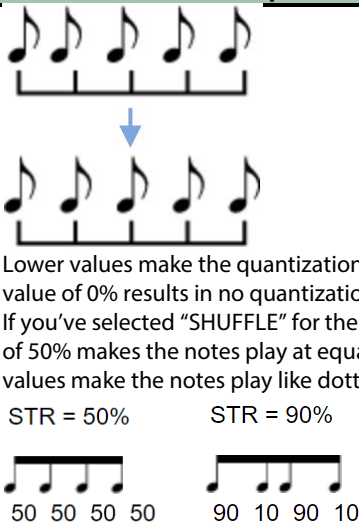
Controller	Parameter	Value	Explanation
			 <p>Lower values make the quantization less obvious, and a value of 0% results in no quantization. If you've selected "SHUFFLE" for the QTZ parameter, a value of 50% makes the notes play at equal intervals, and larger values make the notes play like dotted notes.</p> <p>STR = 50% STR = 90%</p> <p>50 50 50 50 90 10 90 10</p>
[SHIFT] button + [CTRL 2] knob	QTZ.START (QS)	Selects the start of the range for quantization.	
[SHIFT] button + [CTRL 3] knob	QTZ.END (QE)	Selects the end of the range for quantization.	

7. Press the [VALUE] knob.

The "Quantize Pattern" message appears.

8. Use the [VALUE] knob to select "OK," and press the [VALUE] knob.

This corrects the timing at which the samples sound to match the specified interval.

MEMO

Once you've quantized a pattern, you can't revert to the way it was before.

Organizing the Pattern Data

This section explains the functions for making effective use of the patterns.

Exchanging (Swapping) Patterns Between Pads

Here's how to exchange (swap) the patterns that are assigned to two different pads.

MEMO

You can't perform the following operations while a pattern is playing back. Stop the pattern before performing the operation.

1. **Hold down the [SHIFT] button and press the pad [5].**

The EXCHANGE screen appears.



2. **Press the two pads in order, for which you want to exchange the patterns.**

To cancel exchanging, press the [EXIT] button.

MEMO

You can use the bank [A/F]–[E/J] buttons to select a bank before pressing the pads. It's also possible to exchange patterns between different banks.

3. **Press the [VALUE] knob or [COPY] button.**

The patterns of the pads are now exchanged.

Copying the Pattern of a Pad

Here's how to copy the pattern that's assigned to a pad to a different pad.

1. **Press the [COPY] button.**

The COPY screen appears.



2. **Press the pads in order, first the pattern (pad) you want to copy and then the copy destination pattern (pad).**



If you decide to cancel copying, press the [EXIT] button.

MEMO

- To copy a pattern to a different bank, first press the bank [A/F]–[E/J] buttons to select the bank before pressing the pattern (pad) for the copy destination.
- You can use the [CTRL 3] knob to select a project, when copying the pattern to a different project.
- You can convert the selected pattern to a sample and then assign that sample to a pad. For details, refer to [“Converting Patterns to Samples \(BOUNCE\)\(P.66\).”](#)
- You can create a pattern using only specific samples that were taken from a selected pattern. For details, refer to [“Extracting Specific Samples \(Pads\) from a Pattern\(P.79\).”](#)
- You can also use [“Converting Patterns to Samples\(P.65\)”](#) together with [“Extracting Specific Samples \(Pads\) from a Pattern\(P.79\).”](#)

3. Press the [VALUE] knob or [COPY] button.

This copies the pattern.

NOTE

Performing this operation overwrites (erases) the pattern in the copy destination pad.

Extracting Specific Samples (Pads) from a Pattern

You can create a pattern using only specific samples that were taken from a pattern that you've inputted using multiple samples.

1. Following the steps in "Copying the Pattern of a Pad", press the source pattern (pad) and then the save destination pattern (pad).



If you decide to cancel, press the [EXIT] button.

MEMO

- If you use the bank [A/F]–[E/J] buttons to select the bank before pressing the pads, you can save the pattern to a different bank.
- You can use the [CTRL 3] knob to select a project, when saving the pattern to a different project.

2. Press the [REMAIN] button.

Samples (pads) that are used by a pattern light up dimly in white.

3. Press the samples (pads) that you want to extract.

The pads light up white.

4. Press the [REMAIN] button.

5. Press the [VALUE] knob or [COPY] button.

The pattern for which only the selected samples are enabled is saved to the specified pad.

NOTE

Performing this operation overwrites (erases) the pattern in the copy destination pad.

Copying all patterns in a bank to another bank

This is how to copy all the patterns in a bank to another bank.

MEMO

You can't perform the following operations while a pattern is playing back. Stop the pattern before performing the operation.

1. Hold down the [COPY] button and press the [EXIT] button.

The COPY BANK screen appears.



2. Press the bank [A/F]–[E/J] buttons to select the bank to copy (source).

3. Turn the [VALUE] knob clockwise to move the cursor.

4. Press the bank [A/F]–[E/J] buttons to select where to copy the bank (destination).



5. Press the [VALUE] knob or [COPY] button.

All the patterns in the bank are copied to the specified bank.

NOTE

Performing this operation overwrites (erases) the pattern in the copy destination pad.

Protecting a Pattern (PROTECT)

This function prevents the samples and patterns assigned to a pad from being overwritten by being copied or edited, or accidentally deleted.

Protection is set on a bank by bank basis. Protection is set for both samples and patterns.

1. Press the bank [A/F]–[E/J] buttons to select the banks to protect.

To select banks F–J, press the bank [A/F]–[E/J] buttons twice to make them blink.

2. Hold down the [SHIFT] button and press the [COPY] button.

A protect confirmation message appears.

To cancel the protect operation, press the [EXIT] button.

3. Use the [VALUE] knob to select “OK”, and press the [VALUE] knob.**MEMO**

To cancel protection, do the same operation again.

Deleting the Pattern from a Pad

Here’s how to delete the pattern assigned to a pad.

MEMO

You can’t perform the following operations while a pattern is playing back. Stop the pattern before performing the operation.

1. Press the [DEL] button.

The DELETE screen appears.

**2. Press the pad containing the pattern that you want to delete.**

If you decide to cancel deleting, press the [EXIT] button.

3. Press the [VALUE] knob or [DEL] button.

The pattern for that pad is deleted.

NOTE

You can’t restore a pad’s pattern after it has been deleted.

If you want to keep your data or make sure it doesn’t get accidentally modified, we recommend that you follow the steps in “[Backing up Your Data \(BACKUP\)](#)(P.120)” to create regular backups.

Deleting all patterns in a bank at once**1. Hold down the [DEL] button and press the [EXIT] button.**

The DELETE BANK screen appears.



2. Press the bank [A/F]–[E/J] buttons.

Select a bank to delete.

3. Press the [VALUE] knob.

The patterns in the selected bank are deleted.

NOTE

You can't restore a pad's pattern after it has been deleted.

If you want to keep your data or make sure it doesn't get accidentally modified, we recommend that you follow the steps in "Backing up Your Data (BACKUP)(P.120)" to create regular backups.

Setting the Tempo

You can set the tempo data for samples and patterns.

This tempo data can be used to change the sample playback speed and pitch, so that you can play in tempo with other songs.

Here we explain about the different tempo data used by this unit.

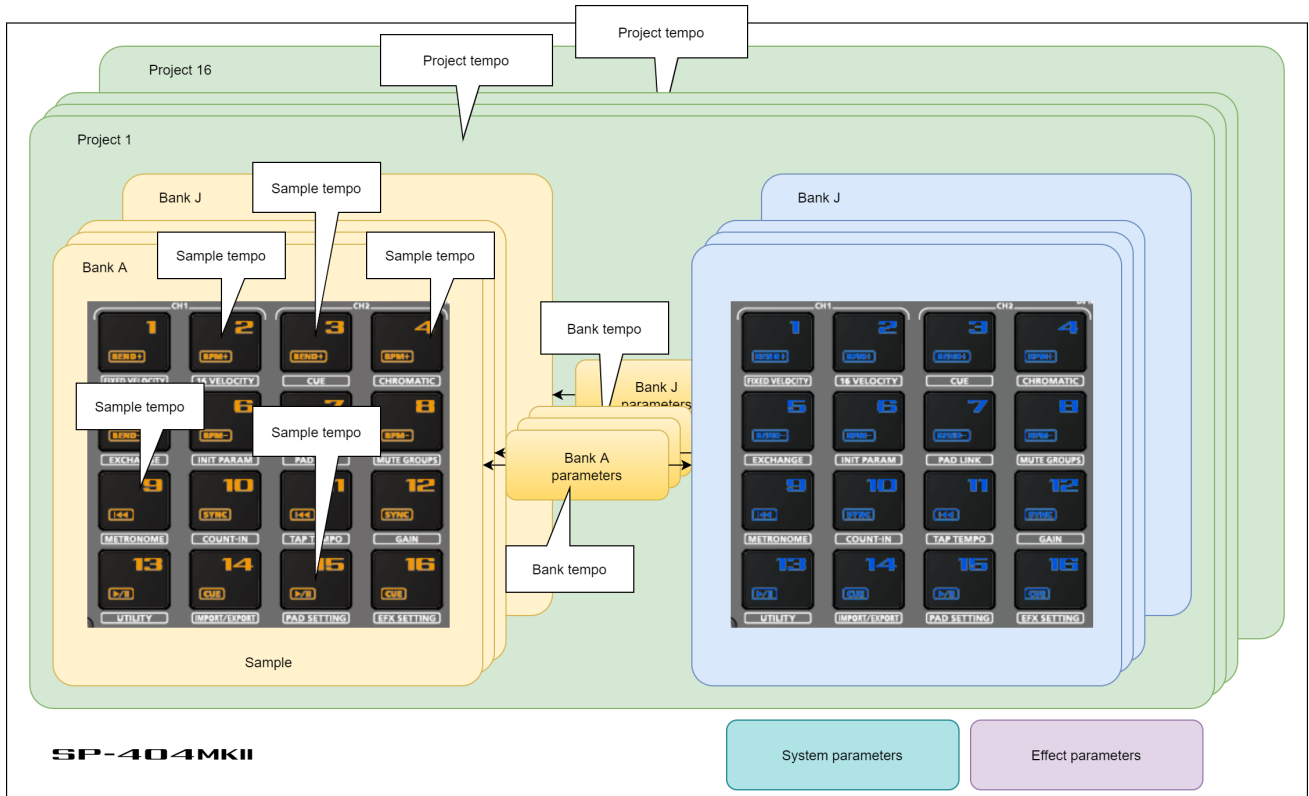

Sample tempo

This is the tempo data used by individual samples.

When a pattern is not playing back, the sample tempo for the sample to play back is enabled (as the standard).

Bank tempo

This is the tempo data used by the banks.

This tempo is common for all samples and patterns saved within the same bank.

This tempo is enabled when the TEMPO SEL parameter is "BANK" (BANK A–BANK J).

The patterns play back at the tempo set for the bank tempo. If BPM SYNC is set to "ON" for a sample, the sample plays back at a tempo converted from the speed that's set as the bank tempo.

Project tempo

This is the tempo data used by a project.

This tempo is common for all samples and patterns saved within the same project.

This tempo is enabled when the TEMPO SEL parameter is "PROJECT".

The patterns play back at the tempo set for the project tempo. If BPM SYNC is set to "ON" for a sample, the sample plays back at a tempo converted from the speed that's set as the project tempo.

Setting the Tempo Data in a Sample

You can set the tempo (BPM) of a sample to make the sample play back in sync with the tempo.

Setting the tempo in AUTO mode

Here's how to detect and set the tempo of a sample.

1. Press the [PITCH/SPEED] button.

The pitch/speed settings screen appears.



2. Press pads [1]–[16] to select the sample you want to edit.
3. Use the [VALUE] knob to change BPM SET to “AUTO,” and press the [VALUE] knob.

“BPM RANGE?” is shown.

Parameter	Value	Explanation
BPM RANGE	SX (Length)	The same method of detecting tempo that's used on the SP-404SX. This detects the tempo according to the sample length. This method is suitable for detecting the tempo when using a sample that's up to around ten seconds long.
	100-199, 80-159, 70-139, 50-99	A method of detecting the tempo that's unique to the SP-404MK2. This analyzes the frequency characteristics over the entire sample to detect the tempo. This specifies the value as the estimated tempo of the sample.

4. Turn and then press the [VALUE] knob.
5. Use the [VALUE] knob to select “OK,” and press the [VALUE] knob.

The sample is analyzed, and the detected tempo is set as the BPM value.

MEMO

You may not be able to accurately detect the tempo (BPM) on some samples. If you're having a hard time getting the right tempo, try making the setting in MANUAL mode.

MANUAL mode

Here's how to manually set the tempo. Use MANUAL mode if you know the tempo of the sample, or if you're having a hard time detecting the correct tempo in AUTO mode.

1. Press the [PITCH/SPEED] button.

The pitch/speed settings screen appears.



2. Press pads [1]–[16] to select the sample you want to edit.
3. Turn the [VALUE] knob to change BPM SET to “MANU,” and press the [VALUE] knob.

Use the “MANU” setting to set the tempo in the 0.1 decimal range and the “MANU-F” setting to set the tempo in the 0.01 decimal range.

4. Use the [VALUE] knob to select the BPM, and press the [VALUE] knob.

Parameter	Value
VALUE	40.00–200.00

MEMO

You can also set the tempo using the tap tempo function.

["Setting the Tempo in Time with the Rhythm \(Tap Tempo\)\(P.86\)"](#)

Setting the Tempo for a Bank or Project

By setting a tempo (BPM) for a bank, the same tempo is used for all patterns within the same bank or project during playback. The tempo you set becomes the base tempo when playing back samples using BPM SYNC.

1. **Hold down the [SHIFT] button and press the pad [11].**

The TEMPO SEL screen appears.



2. **Use the [CTRL 1] knob to select the base tempo used for BPM SYNC or for playing back patterns.**

Value	Explanation
PROJECT	Uses the project tempo as the base tempo.
BANK A-BANK J	Uses the bank tempo as the base tempo. The value displayed changes according to the currently selected bank.

3. **Use the [VALUE] knob to set the tempo, and then press the [EXIT] button.**

MEMO

- Hold down the [SHIFT] button and turn the [VALUE] knob to set the decimal value of the tempo.
- You can also set the tempo using the tap tempo function.
→ "Setting the Tempo in Time with the Rhythm (Tap Tempo)(P.86)"

Setting the Tempo in Time with the Rhythm (Tap Tempo)

This feature lets you set the tempo in an intuitive way by tapping the pad in time, as if you were clapping out the beat (Tap Tempo).

This is useful function when you want to play in time with other instruments or to the rhythm of a song.



MEMO

The tap tempo function is enabled when the [SUB PAD] button is blinking orange. On the input setting screen and other screens, tap tempo is automatically enabled.

1. **Hold down the [SHIFT] button and press the pad [11].**

This enables the tap tempo function. When this happens, the [SUB PAD] button blinks orange.



2. **Tap the [SUB PAD] button several times in time with the beat.**

The tempo (BPM) appears on the screen to indicate the interval (timing) at which you're tapping the [SUB PAD] button.

3. **Once you've confirmed the tempo setting, press the [EXIT] button.**

This exits the tap tempo screen. This tempo is set for the project or bank.

Mixing the Samples (DJ MODE)

You can assign two samples to CH1 and CH2 and mix them freely.

1. Press the bank [D/I] button and the [E/J] button simultaneously.

The unit enters DJ MIXER mode.

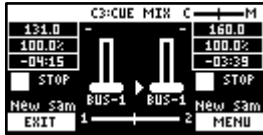

2. Select the samples to respectively assign to CH1 and CH2.

1. Press the [VALUE] knob.

A menu appears.



2. Use the [VALUE] knob to select "CH1 SELECT" or "CH2 SELECT," and press the [VALUE] knob.



3. Press pads [1]–[16] to select the sample to assign to either CH1 or CH2.



MEMO

Press a pad to preview its sample. You may not be able to hear the samples at this time if the CH1 LEVEL or CH2 LEVEL is too low. Turn the [CTRL 1] or [CTRL 2] knobs to adjust the volume.

4. Use the [VALUE] knob to select "ENTER," and press the [VALUE] knob.
5. Once you've assigned a sample to CH1, use the same operation to assign a sample to CH2.
6. Use the [CTRL 1]–[CTRL 3] knobs and press pads [1]–[16] to mix the sound.

Controller	Parameter	Action
[CTRL 1] knob	CH1 LEVEL	Adjusts the volume of CH1.
[CTRL 2] knob	CH2 LEVEL	Adjusts the volume of CH2.
[CTRL 3] knob	CUE MIX	Adjusts the balance of the audio you monitor via the PHONES jack. When this is set to the "C" side, you can monitor the sample audio sent to CUE. When this is set to the "M" side, you can monitor the audio output to the LINE OUT jacks and the USB port. → "Monitoring with Headphones (CUE)(P.95)"
	X-FADE	Crossfades between CH1 and CH2. You can make CH2 fade in while CH1 is fading out, or the opposite.
CH1: Pad [13] CH2: Pad [15]	▶/	Switches between play/pause.
CH1: Pad [9] CH2: Pad [11]	◀◀	Returns to the playback start position.
CH1: Pad [14] CH2: Pad [16]	CUE	Sends the sample audio to CUE. → "Monitoring with Headphones (CUE)(P.95)"
Pad [10] or pad [12]	SYNC	Synchronizes the tempo (BPM) of two samples.

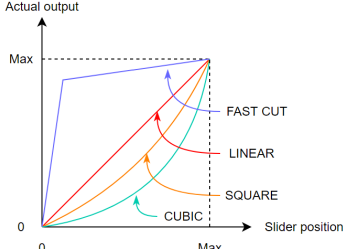
Controller	Parameter	Action
		When pad [10] is pressed, the CH1 sample follows the tempo of the CH2 sample. When pad [12] is pressed, the CH2 sample follows the tempo of the CH1 sample.
CH1: Pad [2] CH2: Pad [4]	BPM+	Speeds up the tempo.
CH1: Pad [6] CH2: Pad [8]	BPM-	Slows down the tempo.
CH1: [DEL] button + Pad [2] + Pad [6] CH2: [DEL] button + Pad [4] + Pad [8]	BPM	Resets the tempo to the default value.
CH1: Pad [1] CH2: Pad [3]	BEND+	The pitch goes up while you hold down the pad. This also speeds up the playback, like an analog turntable.
CH1: Pad [5] CH2: Pad [7]	BEND-	The pitch goes down while you hold down the pad. This also slows down the playback, like an analog turntable.
CH1: [REMAIN] button + Pad [14] CH2: [REMAIN] button + Pad [16]	BUS FX	You can set the bus to which the CH1/CH2 sample playback is sent (meaning which effects are used). While holding down the [REMAIN] button, each time you press pad [14] or pad [16] switches the effect to use as follows: "BUS-1" -> "BUS-2" -> "DRY" -> "BUS-1".
CH1: [ROLL] button + Pad [13] CH2: [ROLL] button + Pad [15]		Repeats the sample playback in more detailed intervals (ROLL). Note that when the ROLL SIZE (roll interval) is longer than the sample length, a roll cannot played back.
[SHIFT] button + [ROLL] knob	ROLL SIZE	Sets the roll interval (1/4, 1/2, 1 or 2 measures). Set the ROLL SIZE before playing back rolls. (You can't change the ROLL SIZE with this operation while a roll is playing back).
[ROLL] button + pads [1]-[4]		Changes the roll interval while the roll is playing back. [ROLL] button + pad [1]: quarter-note (1/4 of a measure) [ROLL] button + pad [2]: half-note (1/2 of a measure) [ROLL] button + pad [3]: whole note (1 measure) [ROLL] button + pad [4]: two whole notes (2 measures)
[START/END] button		Switches between the functions (CUE MIX or X-FADE) for the [CTRL 3] knob.
[PITCH/SPEED] button		Changes the number of digits shown for the BPM. Each time you press the [PITCH/SPEED] button, the display switches in the following order: integers only -> to the second decimal place -> to the first decimal place -> integers only.... When you set the BPM value using pads [2] [4] (BPM+) and pads [6] [8] (BPM-), the number of digits shown for the BPM changes according to the minimum unit.
[MARK] button		Switches between the EFX and MIXER screen views.
[BPM SYNC] button		Selects the channel (CH1/CH2) used to control reverse playback ([REVERSE] button).
[REVERSE] button	REVERSE	Starts reverse playback immediately from the playback position of the current sample. When playing back in reverse, this works the same as when the "Reverse Type(P.124)" system parameter is set to "303".
CH1: [SHIFT] button + [REVERSE] button + Pad [13] CH2: [SHIFT] button + [REVERSE] button + Pad [15]	MUTE	Mutes the sample that's playing back.
Press [RESAMPLE] button + [VALUE] knob	VOLUME CURVE	Selects the volume curve characteristics used for each slider (CH1 LEVEL, CH2 LEVEL, X-FADE) in DJ mode. 

Controller	Parameter	Action
		Each time you hold down the [RESAMPLE] button and press the [VALUE] knob, the characteristic switches in this order: "FAST CUT" -> "LINEAR" -> "SQUARE" -> "CUBIC" -> "FAST CUT".

MEMO

This lets you change how the pitch sounds (how the audio is processed) when changing the playback speed of a sample in DJ mode.

For details, refer to "DJ mode TS type(P.124)".

Playing Back Samples While in DJ Mode (PAD MODE)

In this mode (pad mode), you can temporarily change the pad arrangement to the same arrangement used in sample mode, while still retaining the same functions of DJ mode.

Pad mode lets you play back samples by pressing pads while you perform in DJ mode.

1. While in DJ mode, press the [HOLD] button.

This switches between DJ mode and pad mode.

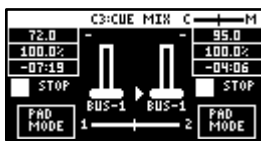

2. Press pads [1]–[16].

The samples assigned to the pads are played back.

MEMO

You can play back samples as long as the sample in question is not being used in DJ mode.

The samples (pads) that are blinking orange are being used in DJ mode, so their samples can't be played back.

Playing Back Patterns While in DJ Mode

In DJ mode, you can play back the patterns that you created.

1. Press the [PATTERN SELECT] button.
2. Press pads [1]–[16] to select a pattern to play back.
3. Press the [PATTERN SELECT] button.
4. Press the [PATTERN EDIT] button.

The [PATTERN EDIT] button blinks, and the pattern playback screen appears.



5. Press the pad [13].

This plays back the pattern.

Use the [CTRL 1]–[CTRL 3] knobs and press pads [1]–[16] to mix the sound, as with the samples.

Playing Back a Sample from the Marker Position

You can play back a sample from the position of the marker that's set for that sample.

1. Press pad [13] or [15].

The corresponding samples play back.

2. Hold down the [SHIFT] button and press pads [1]–[16].

The samples play back from the marker positions set for the samples.

The relationship between the markers where playback begins and the pads are as follows.

CH1 sample		CH2 sample	
1: Beginning of sample	2: Marker 1	3: Beginning of sample	4: Marker 1
5: Marker 2	6: Marker 3	7: Marker 2	8: Marker 3
9: Marker 4	10: Marker 5	11: Marker 4	12: Marker 5
13: Marker 6	14: Marker 7	15: Marker 6	16: Marker 7

MEMO

- Markers up through the seventh marker from the beginning of the sample are recognized in DJ mode. Markers from the eighth marker onwards are ignored (and cannot be selected).
- When you press pads [1]–[16] while holding down the [SHIFT] button, playback begins immediately from the specified marker, even if a sample is already playing back.
- If you press the [REMAIN] button while holding down the [SHIFT] button, the [SHIFT] button remains in a pressed-down state, even after you take your fingers off the buttons. Selecting a marker makes playback easier. Press the [EXIT] button to cancel this behavior.

Adding a Marker While Playing Back a Sample

You can add markers while playing samples in DJ mode.

1. **Play back a sample.**
2. **Hold down the [SHIFT] button and press the [MARK] button at the position where you want to add a marker.**

This adds a marker to the sample.

MEMO

You can add up to seven markers.

Editing a Marker While Playing Back a Sample

You can edit markers while playing samples in DJ mode.

1. **Press pad [13] or [15].**
The corresponding samples play back.
2. **Hold down the [SHIFT] button and press the [START/END] button.**

The marker edit screen appears.

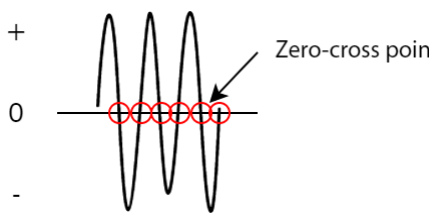
Controller	Action
[MARK] button	Adds a marker.
[CTRL 1] knob	Moves the cursor.
[CTRL 2] knob	Moves the marker.
[CTRL 3] knob	Selects a marker.
[SHIFT] button + [CTRL] knob (turn)	Zooms the area around each point in/out.
[VALUE] knob (turn)	Zooms the area in/out around each point you just manipulated.
[VALUE] knob (press)	You can use a numerical value to set the position of each point. Use the [VALUE] knob to select the point to set, and press pads [1]–[10] to input the position (press pad [10] to input a "0"). To confirm the inputted position, press the [VALUE] knob.
[SHIFT] button + [VALUE] knob (turn)	Adjusts the volume of the channel.
[DEL] button + pads [1]–[8]	Deletes the marker.
[RESAMPLE] button	<p>Moves the start point to the zero cross-point (*) that's closest to the start point time (SNAP to Zero-Cross function). Similarly, the loop point and end point are also moved. This function is enabled when the [RESAMPLE] button is lit.</p> <p>* The "zero cross-point" is the time at which the value of the sample waveform crosses from zero into a positive or negative number.</p> <div style="text-align: center; margin-top: 10px;">  </div>
[ROLL] button	While this button is pressed, you can preview the sound several seconds before the end point.
Pad [13]	Switches between play/pause.
Pad [9]	Returns to the playback start position.

Deleting All Set Markers from a Sample

While in DJ mode, you can delete the markers you've set for samples.

1. Hold down the [SHIFT] and [DEL] buttons, and press pads [1]–[16].

Select the marker to delete.

The relationship between the markers to delete and the pads are as follows.

CH1 sample		CH2 sample	
1:	2: Marker 1	3:	4: Marker 1
5: Marker 2	6: Marker 3	7: Marker 2	8: Marker 3
9: Marker 4	10: Marker 5	11: Marker 4	12: Marker 5
13: Marker 6	14: Marker 7	15: Marker 6	16: Marker 7

MEMO

- As pads [1] and [3] are at the start of the sample, they can't be deleted (these are not markers).
- When you delete a marker, all following markers are moved back in sequence.
- Markers up through the seventh marker from the beginning of the sample are recognized in DJ mode. Markers from the eighth marker onwards are ignored (and cannot be deleted).
Note that when you delete a marker from 1 to 7, all of the following markers are moved back in sequence, so you can delete the eighth marker in this case.

Editing a Sample in DJ Mode

You can edit the samples that are used in DJ mode.

- 1. Press the [VALUE] knob.**

A menu appears.



- 2. Use the [VALUE] knob to select "CH1 EDIT" or "CH2 EDIT," and press the [VALUE] knob.**

The sample edit screen appears. The editing method is the same as for sample edit in sample mode.



Controller	Action
[CTRL 1] knob	Moves the start point.
[CTRL 2] knob (when the loop is on)	Moves the loop point.
[CTRL 3] knob	Moves the end point.
[SHIFT] button + [CTRL] knob (turn)	Zooms the area around each point in/out.
[VALUE] knob (turn)	Zooms the area in/out around each point you just manipulated.
[VALUE] knob (press)	You can use a numerical value to set the position of each point. Use the [VALUE] knob to select the point to set, and press pads [1]–[10] to input the position (press pad [10] to input a "0"). To confirm the inputted position, press the [VALUE] knob.
[SHIFT] button + [VALUE] knob (turn)	Adjusts the volume of the channel.
[DEL] button	Initializes the start and end point positions. <ul style="list-style-type: none"> When a confirmation message appears, use the [VALUE] knob to select "OK," and press the [VALUE] knob.
[REMAIN] button	On: Prevents the start point from being moved beyond the loop point or the end point. Off: When the start point moves beyond the loop point or the end point, this moves the loop point or the end point as well.
[ROLL] button	While this button is pressed, you can preview the sound several seconds before the end point.

Monitoring with Headphones (CUE)

Adjusts the balance of the audio output from the PHONES jack.

When the sample audio is sent to CUE, the audio is only output from the PHONES jack (and is not output to the LINE OUT jack or USB port). When playing live or in similar situations, only the player can preview (check) the sample's sound in headphones.

1. **Hold down the [SHIFT] button and press the pad [3].**

The unit switches to CUE mode.



2. **Adjust the volume balance with the CTRL [3] knob.**

When this is set to the "C" side, you can monitor the sample audio sent to CUE. When this is set to the "M" side, you can monitor the audio output to the LINE OUT jacks and the USB port.

3. **To exit CUE mode, press the [EXIT] button.**

MEMO

You can't send two or more samples to CUE at the same time (playback is not possible).

Inputting Sound from an Electronic Musical Instrument, Mic or Guitar

You can connect your electronic musical instrument, mic or guitar to the SP-404MK2 for audio input.

1. **Connect an electronic musical instrument to the LINE IN jack(s) on the rear panel. When using a mic or guitar, plug them into the INPUT jack on the front panel.**

MEMO

You can connect high-impedance devices like guitars and bass guitars to the INPUT jack on the front panel. When connecting a guitar or bass guitar, set the [MIC/GUITAR] switch on the front panel to the right-hand side.

2. **Press the [EXT SOURCE] button.**

The [EXT SOURCE] button lights up. This inputs the audio of the connected device.

MEMO

The [EXT SOURCE] button blinks red if the level of the input signal is too high. In this case, the input audio may sound distorted.

3. **Hold down the [SHIFT] button and press the [EXT SOURCE] button.**

The input setting screen appears.



4. **Turn the [CTRL 3] knob to adjust the volume of the audio input.**
5. **When you finish making the settings, press the [EXIT] button.**
6. **To stop the audio input from the connected device, press the [EXT SOURCE] button.**

The [EXT SOURCE] button goes dark. This stops the audio from the connected device.

Inputting Audio from a Computer or Mobile Device (USB AUDIO)

The SP-404MK2 can receive audio input from a computer or mobile device (such as a smartphone or tablet).

Configuring the OS audio settings

You must make the appropriate settings on your computer when inputting audio from a computer to the SP-404MK2.

For Windows

1. **Open the Control Panel.**
2. **Click the “Hardware and Sound” icon, and then click the “Sound” icon.**
If the panel is displaying as icons or in classic view, double-click the [Sound] icon.
3. **Click the [Playback] tab.**
4. **Click “Speakers SP-404MKII-G”, and click the “Set Default” button.**
5. **Click the [OK] button.**

For macOS

1. **Open the System Preferences.**
2. **Click the [Sound] icon.**
3. **Click the [Output] tab and select [SP-404MKII-OUT].**
4. **Close the System Preferences.**

Enabling audio from a computer or mobile device

1. **Connect your computer to the SP-404MK2 with a USB cable.**
2. **Press the [EXT SOURCE] button on the SP-404MK2.**
3. **The [EXT SOURCE] button is lit. Input the audio from your computer or mobile device into the SP-404MK2.**

Selecting a Project

Here's how to recall a project (1–16).

Once a project is recalled, the unit is ready to play back samples and create patterns.

1. **Hold down the [SHIFT] button and press the [SUB PAD] button.**

The SELECT PROJECT screen appears.



2. **Press pads [1]–[16] to select a project you want to recall.**

The project is recalled. Once the project is recalled, the top screen appears.

Organizing Projects

On this unit, you can copy projects and delete projects you no longer need.

Copying a Project

Here's how to copy a project.

1. **Hold down the [SHIFT] button and press the [SUB PAD] button.**

The SELECT PROJECT screen appears.



2. **Press the [COPY] button**

The COPY PROJECT screen appears.



3. **Press the pads in order, beginning with the pad you want to copy (project), and then the copy destination pad.**



If you decide to cancel copying, press the [EXIT] button.

4. **Press the [VALUE] knob or [COPY] button.**

The project is now copied.

NOTE

Performing this operation overwrites (erases) the project in the copy destination pad.

Deleting a Project

Here's how to delete projects you don't need.

1. **Hold down the [SHIFT] button and press the [SUB PAD] button.**

The SELECT PROJECT screen appears.



2. **Press the [DEL] button.**

The project deletion screen appears.



3. **Press pads [1]–[16] to select the project to delete.**

If you decide to cancel deleting, press the [EXIT] button.

4. **Press the [VALUE] knob or [DEL] button.**

This deletes the project data.

NOTE

You can't restore a project after it has been deleted.

If you want to keep your project data or make sure it doesn't get accidentally modified, we recommend that you follow the steps in "[Backing up Your Data \(BACKUP\)](#)(P.120)" to create regular backups.

Customizing This Unit

You can customize the design of this unit to match your tastes.

Attaching/Removing the Faceplate of This Unit

You can remove the faceplate of this unit to customize the top panel.

NOTE

- Make sure you don't cut your fingers on the edges when removing or attaching the faceplate.
- The faceplate may bend if it is exposed to strong impact when removed. If this happens, you may not be able to reattach it.

Removing the faceplate

1. Use a commercially available hex wrench (2 mm) to remove the two screws (at the front of the unit) circled in blue.

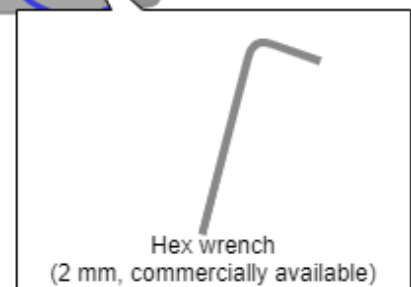

2. Remove the screws (at the far side of the unit) circled in red.

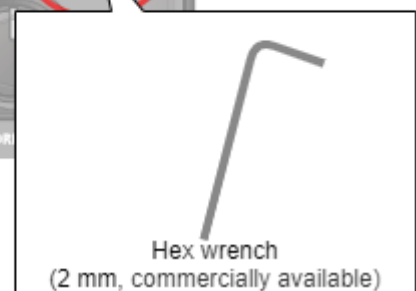

Attaching the faceplate

To attach the faceplate, follow the steps for removing the top panel in reverse order.

1. **Use a commercially available hex wrench (2 mm) to attach the two screws (at the far side of the unit) circled in red.**
2. **Install the two screws (at the front of the unit) circled in blue.**

MEMO

Overtightening the screws may damage the screw holes.

Customizing the Opening Screen

You can use your own custom images for the opening screen.

Two opening images can be registered per project.

Steps for setting your custom image data as the opening image

You must perform the following operations (summarized) to use your custom image data as the opening image.

1. **Create your custom image (Preparing a Screen Saver Image(P.104)).**
2. **Export the project to an SD card (Exporting a Project (EXPORT PROJECT)(P.119)).**
3. **Save your custom images to the SD card (Saving the Screen Saver Image to a Project(P.105)).**
4. **Load the project from the SD card (Importing a Project (IMPORT PROJECT)(P.118)).**

Preparing an Opening Image

Create your custom image in the format shown below.

Format	Specifications
Image file format	BMP
Size	128 (x) × 64 (y) pixels
Color depth	1-bit, 4-bit, 8-bit, 24-bit <ul style="list-style-type: none"> ● Note that only monochromatic images can be displayed. Intermediate colors cannot be displayed.
Filename and extension	startup_*.bmp Substitute a number (1–2) for the asterisk. The unit does not recognize filenames in any other format. If the filename is not recognized, the default opening screen is shown.

Saving an Opening Image to a Project

Here's how to save your custom image to a project. As an example, the following shows how to change the opening image of project 01 to your own custom image.

1. **Export the project for which you want to change the opening image (project 01 in this example) to an SD card ("Exporting a Project (EXPORT PROJECT)(P.119)").**
2. **Remove the SD card from this unit, and open the contents on your computer.**
3. **Copy the opening image that's saved in the SD card to the "EXPORT/PROJECT/PROJECT_01/PICTURE" folder. Change the filename to "startup_*.bmp", replacing the asterisk with a number from 1 to 2.**

For details on the "/EXPORT/PROJECT/PROJECT_01/PICTURE" folder, see the folder structure diagram shown in "Importing/Exporting (Using the SD Card)(P.114)".

4. **Remove the SD card from your computer, and insert it into this unit.**
5. **Import the project in which the opening image is registered ("Importing a Project (IMPORT PROJECT)(P.118)").**

Your custom opening image is displayed from the next time the unit starts up.

Customizing the Screen Saver

You can set your own custom image as the screen saver image.

A maximum of 16 screen saver images can be registered per project.

Steps for using your custom images as the screen saver

You must perform the following operations (summarized) to use your custom images as the screen saver.

1. **Create your custom image (Preparing a Screen Saver Image(P.104)).**
2. **Switch the settings to use a custom screen saver (Enabling a Custom Screen Saver(P.104)).**
3. **Export the project to an SD card (Exporting a Project (EXPORT PROJECT)(P.119)).**
4. **Save your custom images to the SD card (Saving the Screen Saver Image to a Project(P.105)).**
5. **Load the project from the SD card (Importing a Project (IMPORT PROJECT)(P.118)).**

Preparing a Screen Saver Image

Create your custom image in the format shown below.

Format	Specifications
Image file format	BMP
Size	128 (x) × 64 (y) pixels
Color depth	1-bit, 4-bit, 8-bit, 24-bit <ul style="list-style-type: none"> ● Note that only monochromatic images can be displayed. Intermediate colors cannot be displayed.
Filename and extension	screen_saver_*.bmp Substitute a number (1–16) for the asterisk. The unit does not recognize filenames in any other format. If the filename is not recognized, the default screen saver is shown.

Enabling a Custom Screen Saver

This shows how you can load a custom image as a screen saver (the “Screen Saver Type” parameter).

1. **Hold down the [SHIFT] button and press the pad [13].**

The UTILITY MENU screen appears.



2. **Use the [VALUE] knob to select “SYSTEM”, and press the [VALUE] knob.**

The system screen appears.



3. **Turn the [CTRL 3] knob to select the “GENERAL” tab.**
4. **Use the [VALUE] knob to move the cursor to “Screen Saver Type”, and press the [VALUE] knob.**

The value display is highlighted, and you can now edit the value.



5. **Use the [VALUE] knob to select “Custom”, and press the [VALUE] knob.**
6. **Press the [EXIT] button.**

Saving the Screen Saver Image to a Project

Here's how to save your custom image to a project. As an example, the following shows how to edit the custom image for the screen saver of project 01.

1. **Prepare the image to use for the screen saver, and edit the settings to use a custom screen saver (“Preparing a Screen Saver Image(P.104)” and “Enabling a Custom Screen Saver(P.104)”).**
2. **Export the project for which you want to change the screen saver (project 01 in this example) to an SD card (“Exporting a Project (EXPORT PROJECT)(P.119)”).**
3. **Remove the SD card from this unit, and open the contents on your computer.**
4. **Copy the screen saver image that's saved in the SD card to the “EXPORT/PROJECT/PROJECT_01/PICTURE” folder. Change the filename to “screen_saver_*.bmp”, replacing the asterisk with a number from 1 to 16.**

For details on the “/EXPORT/PROJECT/PROJECT_01/PICTURE” folder, see the folder structure diagram shown in “Importing/Exporting (Using the SD Card)(P.114)”.

5. **Remove the SD card from your computer, and insert it into this unit.**
6. **Import the screen saver image into the project where it was registered (“Importing a Project (IMPORT PROJECT)(P.118)”).**

The screen saver that uses your custom screen saver is shown.

Configuring the Various Settings (UTILITY)

This menu lets you edit the parameters and view information related to the overall unit.

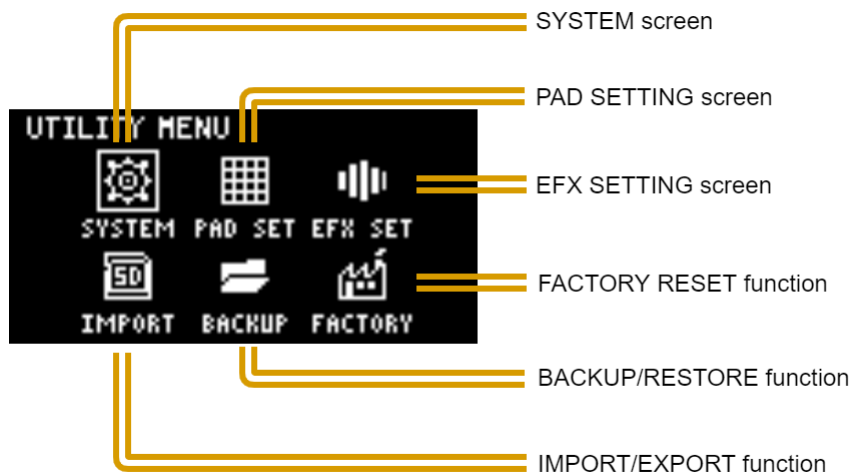

Editing the Settings Related to this Unit (System)

Here's how to configure the overall settings for this unit.

1. **Hold down the [SHIFT] button and press the pad [13].**

The UTILITY MENU screen appears.



2. **Use the [VALUE] knob to select "SYSTEM", and press the [VALUE] knob.**

The system setting screen appears. Each parameter is shown as divided into five tabs (groups).



3. **Turn the [CTRL 3] knob to select a tab.**

Select the tab of the parameter you want to edit.

4. **Turn the [VALUE] knob to move the cursor to the parameter that you want to edit, and press the [VALUE] knob.**

The value display is highlighted, and you can now edit the value.

For details on the parameters, refer to "SYSTEM(P.123)" in the Parameter Guide.

5. **Turn the [VALUE] knob to edit the value, and press the [VALUE] knob.**

This confirms the value.

6. **Press the [EXIT] button to return to the UTILITY MENU screen.**

Configuring the Pad-related Settings (PAD SETTING)

The pad setting screen lets you configure various pad-related settings.

1. **Hold down the [SHIFT] button and press the pad [13].**

The UTILITY MENU screen appears.



2. **Use the [VALUE] knob to select "PAD SET", and press the [VALUE] knob.**

The pad setting screen appears.



MEMO

From the top screen, you can also make this screen appear by pressing pad [15] while holding down the [SHIFT] button.

3. **Turn the [CTRL 3] knob to select a tab.**

The PAD SETTING screen is divided into four tabs (groups). Select the tab of the group that contains the parameter you want to edit.

4. **Use the [VALUE] knob to move the cursor to the parameter you wish to edit, and press the [VALUE] knob.**

The value display is highlighted, and you can now edit the value.

For details on the parameters, refer to "PAD SET(P.126)" in the Parameter Guide.

5. **Turn the [VALUE] knob to edit the value, and press the [VALUE] knob.**
6. **Press the [EXIT] button to return to the UTILITY MENU screen.**

Configuring the Effect Settings (EFX SET)

This shows how to edit the routing (connection order) for the effects built into this unit, and how to configure the effects to use.

1. **Hold down the [SHIFT] button and press the pad [13].**

The UTILITY MENU screen appears.



2. **Use the [VALUE] knob to select "EFX SET", and press the [VALUE] knob.**

The effect setting screen appears. Each parameter is shown as divided into five tabs (groups).



MEMO

From the top screen, you can also make this screen appear by pressing pad [16] while holding down the [SHIFT] button.

3. **Turn the [CTRL 3] knob to select a tab.**
4. **Select the tab of the parameter you want to edit.**

Tab	Explanation
FAVORITE	Shows the current BUS FX settings. Use the [VALUE] knob to change the FAVORITE number.
BUS 3, BUS 4	Edits the parameters of the effects (BUS 3, BUS 4) applied to the overall sound.
DIRECT	You can assign the effects you like to the effect buttons on the top panel.
OTHER	Sets the BUS FX routing and effects to apply to external input.

5. **Use the [VALUE] knob to move the cursor to the parameter you wish to edit, and press the [VALUE] knob.**

The value display is highlighted, and you can now edit the value.
For details on the parameters, refer to "Parameter Guide(P.123)".

6. **Turn the [VALUE] knob to edit the value, and press the [VALUE] knob.**
7. **Press the [EXIT] button to return to the UTILITY MENU screen.**

Configuring the Effect Routing

This shows how to edit the routing (connection order) for the effects built into this unit.

1. **Hold down the [SHIFT] button and press the pad [13].**

The UTILITY MENU screen appears.



2. **Use the [VALUE] knob to select "EFX SET", and press the [VALUE] knob.**

The effect setting screen appears.



MEMO

From the top screen, you can also make this screen appear by pressing pad [16] while holding down the [SHIFT] button.

3. **Use the [CTRL 3] knob to select "FAVORITE", and press the [VALUE] knob.**

The position of the effect assigned to BUS 1 and BUS 2 changes each time you press the [VALUE] knob (“Using the Effects(P.29)”).

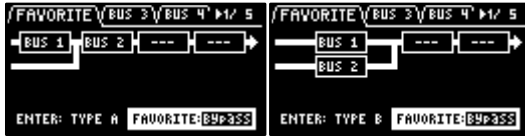

4. To finish making the settings, press the [EXIT] button.

Adding Effects to the Overall Sound (BUS 3, BUS 4)

Here's how to apply effects to the overall sound output from this unit.

1. Hold down the [SHIFT] button and press the pad [13].

The UTILITY MENU screen appears.



2. Use the [VALUE] knob to select “EFX SET”, and press the [VALUE] knob.

The effect setting screen appears.



MEMO

From the top screen, you can also make this screen appear by pressing pad [16] while holding down the [SHIFT] button.

3. Turn the [CTRL 3] knob to select “FAVORITE”.
4. Turn the [VALUE] knob to select “FAVORITE 1” through “FAVORITE 16”.

The effects you selected in “FAVORITE 1” through “FAVORITE 16” are applied to the overall output audio.



5. To finish making the settings, press the [EXIT] button.

Changing the Effects Assigned to BUS 3 and BUS 4

Changes the type of effects to apply to the overall sound.

MEMO

Refer to “Adding Effects to a Sample (BUS FX)(P.29)” to change the type of effects (BUS 1, BUS 2) that are applied to the samples.

1. Hold down the [SHIFT] button and press the pad [13].

The UTILITY MENU screen appears.



2. Use the [VALUE] knob to select “EFX SET”, and press the [VALUE] knob.

The effect setting screen appears.



MEMO

From the top screen, you can also make this screen appear by pressing pad [16] while holding down the [SHIFT] button.

3. Turn the [CTRL 3] knob to select "FAVORITE".
4. Turn the [VALUE] knob to select "FAVORITE 1" through "FAVORITE 16".

The effects you selected in "FAVORITE 1" through "FAVORITE 16" are applied to the overall output audio.



5. Use the [CTRL 3] knob to select "BUS 3" or "BUS 4", and press the [VALUE] knob.

The value display is highlighted, and you can now change the effects.



6. Use the [VALUE] knob to select the effect, and press the [VALUE] knob.

This confirms the EFX Type.



7. To finish making the settings, press the [EXIT] button.

MEMO

Press the [BUS FX] button while holding down the [VALUE] knob to temporarily bypass the BUS 3 and BUS 4 effects.

Editing the Effects for BUS 3 and BUS 4

Here's how to edit the effects (BUS 3, BUS 4) applied to the overall sound.

MEMO

See "Editing the Effects(P.33)" for how to edit the effects (BUS 1, BUS 2) applied to a sample.

1. Hold down the [SHIFT] button and press the pad [13].

The UTILITY MENU screen appears.



2. Use the [VALUE] knob to select "EFX SET", and press the [VALUE] knob.

The effect setting screen appears.



MEMO

From the top screen, you can also make this screen appear by pressing pad [16] while holding down the [SHIFT] button.

3. Use the [CTRL 3] knob to select "BUS 3" or "BUS 4".

Select the bus whose effect you wish to change.



MEMO

To edit BUS 3 and BUS 4, you must select a favorite from “FAVORITE 1” to “FAVORITE 16” in the “FAVORITE” tab screen.

4. Turn the [VALUE] knob to set the parameter to edit.



5. Use the [CTRL 1]–[CTRL 3] knobs to edit the parameter.
6. To finish making settings, press the [EXIT] button.

Assigning the Desired Effect to an Effect Button (DIRECT FX)

You can assign the effects you like to the effect buttons on the top panel.

1. Hold down the [SHIFT] button and press the pad [13].

The UTILITY MENU screen appears.



2. Use the [VALUE] knob to select “EFX SET”, and press the [VALUE] knob.

The effect setting screen appears.



MEMO

From the top screen, you can also make this screen appear by pressing pad [16] while holding down the [SHIFT] button.

3. Turn the [CTRL 3] knob to select “DIRECT”.



4. Use the [VALUE] knob to select the effect button to which the effect is to be assigned.

Effect button to assign	Parameter
[FILTER+DRIVE] button	Direct FX1
[RESONATOR] button	Direct FX2
[DELAY] button	Direct FX3
[ISOLATOR] button	Direct FX4
[DJFX LOOPER] button	Direct FX5

MEMO

You can also press an effect button to change its assigned effect.

5. Press the [VALUE] knob.

The value display is highlighted, and you can now change the effects.



6. Use the [VALUE] knob to select the effect, and press the [VALUE] knob.

The effect is assigned to the effect button you selected. After this, you can use the effect buttons on the top panel to switch the assigned effects on/off.

7. To finish making settings, press the [EXIT] button.

Configuring the Input Effects (INPUT FX)

The INPUT FX (input effects) are effects used only for the input jacks. You can apply effects to the audio that's inputted to this unit.

MEMO

These are the same parameters as the "INPUT FX parameters", which are used for sampling and resampling.

1. Hold down the [SHIFT] button and press the pad [13].

The UTILITY MENU screen appears.



2. Use the [VALUE] knob to select "EFX SET", and press the [VALUE] knob.

The effect setting screen appears.



MEMO

From the top screen, you can also make this screen appear by pressing pad [16] while holding down the [SHIFT] button.

3. Turn the [CTRL 3] knob to select "OTHER".



4. Use the [VALUE] knob to move the cursor to "Input FX", and press the [VALUE] knob.

The value display is highlighted, and you can now change the effects.



Parameter	Value
EFX Type	Bypass, Auto Pitch(*), Vocoder(*), Harmony(*), Gt Amp Sim(*), Chorus, JUNO Chorus, Reverb, TimeCtrlDly, Chromatic PS, Downer, WrmSaturator, 303 VinylSim, 404 VinylSim, Cassette Sim, Lo-fi, Equalizer, Compressor

MEMO

- Effects marked with an (*) are for INPUT FX only.
- For details on the various effect parameters, refer to "MFX List(P.129)".

5. Use the [VALUE] knob to select the effect, and press the [VALUE] knob.

This sets the effect.

- To finish making settings, press the [EXIT] button.

Sending the Audio Input from the INPUT Jack to a Bus

You can set the bus to which the playback audio signals coming into the INPUT jack are sent (meaning which effects are used).

- Hold down the [SHIFT] button and press the pad [13].

The UTILITY MENU screen appears.



- Use the [VALUE] knob to select "EFX SET" and press the [VALUE] knob.

The effect setting screen appears.



MEMO

From the top screen, you can also make this screen appear by pressing pad [16] while holding down the [SHIFT] button.

- Turn the [CTRL 3] knob to select "OTHER".



- Use the [VALUE] knob to move the cursor to "Input Bus" and press the [VALUE] knob.

The displayed value is highlighted, and you can now edit the Input Bus.

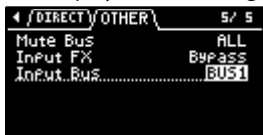

Value	Explanation
DRY	The signal is not sent to BUS 1, BUS 2 (the BUS 1 and BUS 2 effects are not used).
BUS1, BUS2	The signal is sent to BUS 1 or BUS 2. The effects set for BUS 1 and BUS 2 are used.

- Use the [VALUE] knob to select the bus, and press the [VALUE] knob.

This confirms the bus to which the input audio is sent.

- To finish making settings, press the [EXIT] button.

Importing/Exporting (Using the SD Card)

Using a SD card lets you import the samples you like into the SP-404MK2, or exchange patterns and other data between different SP-404MK2 units.

To work with data on the SD card, the SD card folder structure must be set up as shown below.

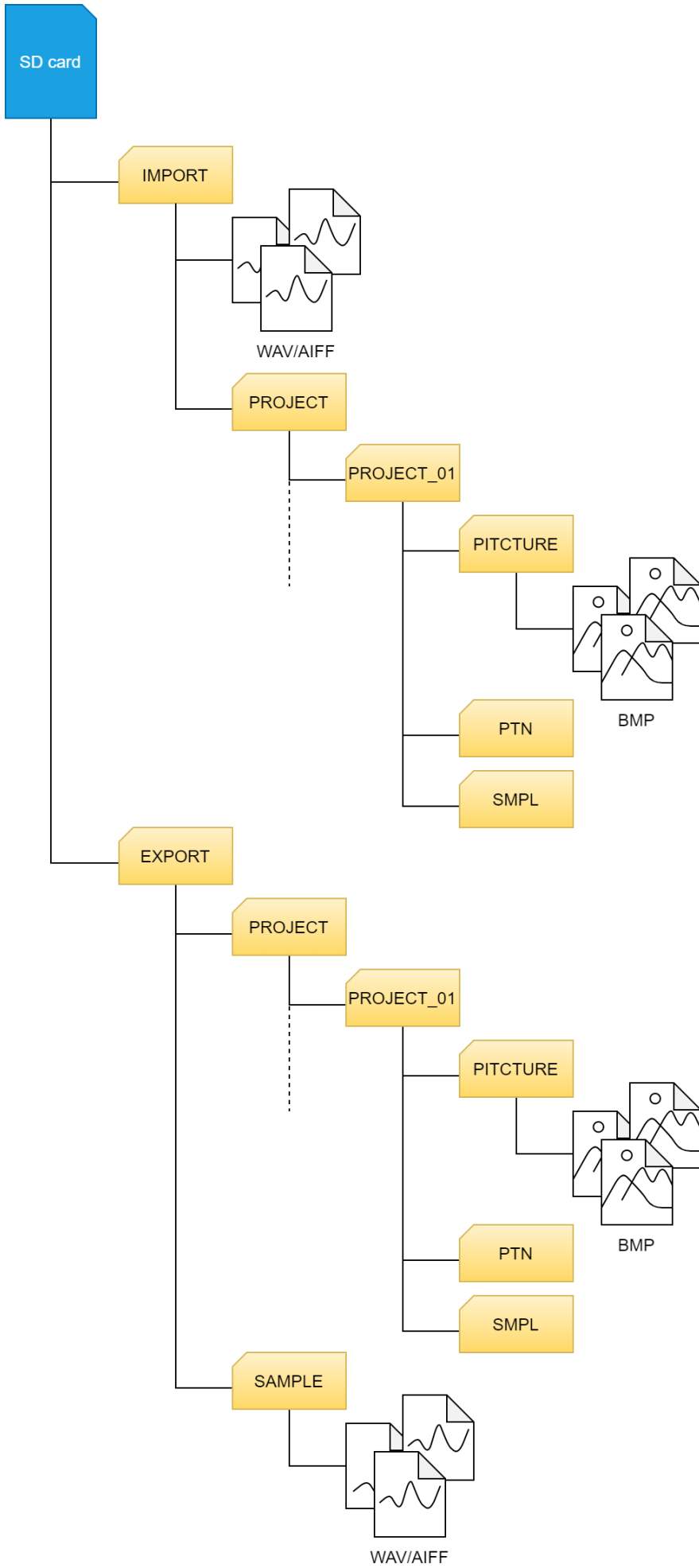

MEMO

Some memory card types or memory cards from some manufacturers may not record or play back properly on the unit.

Importing Samples (IMPORT SAMPLE)

You can import commercially available audio material or audio material created on your computer from an SD card.

1. **Using your computer or similar device, save the samples you wish to import to the “IMPORT” folder on the SD card (Importing/Exporting (Using the SD Card)(P.114)).**
2. **Insert the SD card on which the samples are saved into the SD card slot of this unit.**
3. **Hold down the [SHIFT] button and press the pad [13].**

The UTILITY MENU screen appears.



4. **Use the [VALUE] knob to select “IMPORT,” and press the [VALUE] knob.**

The IMPORT/EXPORT MENU screen appears.



MEMO

From the top screen, you can also make this screen appear by pressing pad [14] while holding down the [SHIFT] button.

5. **Use the [VALUE] knob to select “IMPORT from SD-CARD,” and press the [VALUE] knob.**

The IMPORT SAMPLE / PROJECT screen appears.



6. **Use the [VALUE] knob to select “SAMPLE,” and press the [VALUE] knob.**



7. **Press pads [1]–[16] to select the pad to which you want to assign the imported sample.**

Normally, you should select a pad that’s blinking yellow (an empty pad).

Pad status	Explanation
Unlit (dark orange)	Sample is already assigned to the pad
Blinking yellow	Sample not yet assigned to the pad (empty pad)
Blinking red	Imported sample assigned to the pad (import destination pad)
Lit red	Imported sample assigned to the pad (overwrite and import to a pad that already has a sample assigned to it)

8. **Use the [VALUE] knob to select the sample to import, and press the [VALUE] knob.**

The samples are imported and assigned to the selected pads.

MEMO

- You can preview the samples when you turn the [VALUE] knob to select a sample (this is the automatic preview function). You can also preview the sample by pressing the [SUB PAD] button.
- When selecting samples inside a folder, use the [VALUE] knob to select the folder, and then press the [VALUE] knob.
- Hold down the [SHIFT] button and turn the [VALUE] knob to select multiple samples.
- Hold down the [MARK] button and turn the [VALUE] knob to quickly scroll through the list of samples.

NOTE

When importing a sample to a pad that already has an assigned sample (pads that are lit up red), a confirmation message appears, asking if you want to overwrite the sample. To overwrite the sample and import a new sample, turn the [VALUE] knob to select “OK,” and press the [VALUE] knob. Performing this operation overwrites (erases) the sample in the copy destination pad.

NOTE

Never turn off the power or remove the SD card while the screen indicates “Working...”

Exporting Samples (EXPORT SAMPLE)

You can export the samples to an SD card to use on your computer or on a different SP-404MK2.

1. **Insert the SD card to which the samples are to be exported into the SD card slot of this unit.**
2. **Hold down the [SHIFT] button and press the pad [13].**

The UTILITY MENU screen appears.



3. **Turn the [VALUE] knob to select “IMPORT”.**

The IMPORT/EXPORT MENU screen appears.



MEMO

From the top screen, you can also make this screen appear by pressing pad [14] while holding down the [SHIFT] button.

4. **Use the [VALUE] knob to select “EXPORT to SD-CARD”, and press the [VALUE] knob.**

The EXPORT SAMPLE / PROJECT screen appears.

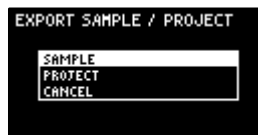

5. **Use the [VALUE] knob to select “SAMPLE”, and press the [VALUE] knob.**



6. **Press the pads of samples that you want to export to the SD card.**

The pads light up orange. You can also select multiple samples (pads) to export. When doing so, press a pad again if you want to deselect its sample for export (the pad blinks orange).

Pad status	Explanation
Unlit (dark orange)	Sample not yet assigned to the pad (empty pad)
Blinking orange	Sample is already assigned to the pad
Lit orange	Pad with a sample to export to the SD card (pad to export)

7. **Select the samples to export and press the [VALUE] knob.**

The selected samples are saved in the “EXPORT SAMPLE” folder of the SD card ([Importing/Exporting \(Using the SD Card\)\(P.114\)](#)).

NOTE

Never turn off the power or remove the SD card while the screen indicates “Working...”.

Importing a Project (IMPORT PROJECT)

You can import a project into this unit that was created on a different SP-404MK2 and exported to an SD card.

1. Follow the steps in “Exporting a Project (EXPORT PROJECT)(P.119)” to export the project(s) to an SD card.
2. Insert the SD card on which the projects are saved into the SD card slot of this unit.
3. Hold down the [SHIFT] button and press the pad [13].

The UTILITY MENU screen appears.



4. Turn the [VALUE] knob to select “IMPORT”.

The IMPORT/EXPORT MENU screen appears.



MEMO

From the top screen, you can also make this screen appear by pressing pad [14] while holding down the [SHIFT] button.

5. Use the [VALUE] knob to select “IMPORT from SD-CARD”, and press the [VALUE] knob.

The IMPORT SAMPLE / PROJECT screen appears.



6. Use the [VALUE] knob to select “PROJECT”, and press the [VALUE] knob.
7. Press the [ROLL] button.

The contents of the “EXPORT” folder are shown. The contents of the project folder (PROJECT_**) that was exported to the SD card are shown.



MEMO

- The contents of the “IMPORT” folder are shown first on the screen where you select the project to import. Each time you press the [ROLL] button, the view switches between the “IMPORT” and “EXPORT” folders.
 - From your computer, you can select the project to export from the “IMPORT” folder list screen.
 1. Open the SD card on your computer.
 2. Move the exported project folder (PROJECT_**) from the “EXPORT” folder to the “IMPORT” folder (Importing/Exporting (Using the SD Card)(P.114)).
8. Press pads [1]–[16] to select the project number to import.

Normally, you should select a pad that’s blinking yellow (an empty pad).

Pad status	Explanation
Unlit (dark orange)	Project number that already contains a project
Blinking yellow	Project number for which a project hasn’t been created (empty project)
Blinking red	Project number to which the imported project is saved
Lit red	Project number to which the imported project is saved (if a project already exists at that project number, it is overwritten with the newly imported project)

9. Turn the [VALUE] knob to select the project to import, and press the [VALUE] knob.

The project is now imported.

NOTE

When you import a project to a project number that already contains a project (the pad lights up red), a message is shown to confirm the overwrite-save.
 To import and overwrite, turn the [VALUE] knob to select "OK", and press the [VALUE] knob.
 Performing this operation overwrites (erases) the project in the import destination.

NOTE

Never turn off the power or remove the SD card while the screen indicates "Working...".

Exporting a Project (EXPORT PROJECT)

You can export projects to an SD card if you want to use them on another SP-404MK2.

1. **Insert the SD card to which the samples are to be exported into the SD card slot of this unit.**
2. **Hold down the [SHIFT] button and press the pad [13].**

The UTILITY MENU screen appears.



3. **Turn the [VALUE] knob to select "IMPORT".**

The IMPORT/EXPORT MENU screen appears.



MEMO

From the top screen, you can also make this screen appear by pressing pad [14] while holding down the [SHIFT] button.

4. **Use the [VALUE] knob to select "EXPORT to SD-CARD", and press the [VALUE] knob.**

The EXPORT SAMPLE / PROJECT screen appears.



5. **Use the [VALUE] knob to select "PROJECT", and press the [VALUE] knob.**



6. **Press the pads of the projects that you want to export to the SD card.**

The pads light up orange.

Pad status	Explanation
Unlit (dark orange)	Pad for which a project hasn't been created (empty pad)
Blinking orange	Pad for which a project has been created
Lit orange	Pad containing a project to be exported to SD card (pad to export)

You can also select multiple projects (pads) to export. When doing so, if you decide not to export a certain project, press its pad again to deselect it (the pad blinks orange).

7. **After you've selected the projects to export, press the [VALUE] knob.**

The selected projects are saved in the "EXPORT PROJECT" folder of the SD card ([Importing/Exporting \(Using the SD Card\)](#)(P.114)).

NOTE

Never turn off the power or remove the SD card while the screen indicates “Working...”.

Backing up Your Data (BACKUP)

By backing up the data on this unit, you can transfer your data to another SP-404MK2 or restore your data in the event that something happens to it.

You can save up to 64 sets of backup data to a single SD card (note that this depends on the SD card’s capacity).

1. **Insert the SD card on which the backup data is to be saved into the SD card slot of this unit.**
2. **Hold down the [SHIFT] button and press the pad [13].**

The UTILITY MENU screen appears.



3. **Use the [VALUE] knob to select “BACKUP”, and press the [VALUE] knob.**

The UTILITY / BACKUP RESTORE screen appears.



4. **Use the [VALUE] knob to select “BACKUP”, and press the [VALUE] knob.**

The backup number selection screen appears.



5. **Use the [VALUE] knob to select a backup number (01–64), and press the [VALUE] knob.**

The backup data is saved to the SD card.

NOTE

If there is already backup data on the SD card with the same number, a message appears that confirms whether you want to overwrite.

To import and overwrite, turn the [VALUE] knob to select “OK”, and press the [VALUE] knob.

When this operation is executed, the backup data on the SD card that has the same number is overwritten (erased).

Restoring from Backup Data (RESTORE)

You can use the backup data that you created with the backup function to restore the data to the SP-404MK2.

NOTE

Note that once you restore data on this unit from the backup data, all data that was saved on this unit is erased (overwritten). To save the data of this unit, use the backup function to make a backup.

1. **Insert the SD card on which the backup data is saved into the SD card slot of this unit.**
2. **Hold down the [SHIFT] button and press the pad [13].**

The UTILITY MENU screen appears.



3. **Use the [VALUE] knob to select “BACKUP”, and press the [VALUE] knob.**

The UTILITY / BACKUP RESTORE screen appears.



4. Use the [VALUE] knob to select “RESTORE”, and press the [VALUE] knob.

The backup number selection screen appears.



5. Use the [VALUE] knob to select a backup number which you want to restore (01–64), and press the [VALUE] knob.

A confirmation message appears, asking if you want to overwrite.

6. To overwrite the existing data and restore the backup data, turn the [VALUE] knob to select “OK”, and press the [VALUE] knob.

This restores the backup data to this unit.

NOTE

Never turn off the power or remove the SD card while the screen indicates “Working...”.

Formatting an SD Card

To use an SD card with this unit, you must first format (initialize) it on the unit.

1. Insert the SD card into the SD card slot.
2. Hold down the [SHIFT] button and press the pad [14].

The IMPORT/EXPORT MENU screen appears.



3. Use the [VALUE] knob to select “FORMAT SD-CARD”, and press the [VALUE] knob.

A confirmation message appears.

If you decide to cancel, press the [EXIT] button.

4. Use the [VALUE] knob to select “OK”, and press the [VALUE] knob.

The SD card is now formatted. When formatting is complete, the screen indicates “Operation Completed!”.

NOTE

Never turn off the power or remove the SD card while the screen indicates “Working...”.

Restoring the Factory Settings (FACTORY RESET)

This operation restores the sample and pattern data as well as the system settings saved on this unit to their factory defaults.

NOTE

Doing this causes all data saved on this unit to be lost.

To save the data of this unit, use the backup function to make a backup ([Backing up Your Data \(BACKUP\)](#)(P.120)).

1. **Hold down the [SHIFT] button and press the pad [13].**

The UTILITY MENU screen appears.



2. **Use the [VALUE] knob to select "FACTORY", and press the [VALUE] knob.**

The UTILITY / FACTORY RESET screen appears.



3. **Turn the [VALUE] knob to select the data to initialize, and press the [VALUE] knob to confirm.**

Value	Explanation (data to initialize)
ALL DATA	This initializes all data. The samples and patterns are restored to the factory default data.
SYSTEM DATA	This restores the settings for the system parameters and effect parameters to their factory defaults. This has no effect on the samples and patterns.

A confirmation message appears, asking if you want to initialize the data.

4. **If you wish to initialize, turn the [VALUE] knob to select "OK", and press the [VALUE] knob.**

The message "Please Power OFF" appears.

5. **Turn this unit's power off, and then on again.**

Appendix

Parameter Guide

SYSTEM

GENERAL



Parameter	Value	Explanation
Edit Knob Mode	CATCH	This sets how the values change when you move the knobs. When you move a knob, control data is only outputted when the position of the knob reaches or “catches up” to the value of its internal parameter. <ul style="list-style-type: none"> In “Mixing the Samples (DJ MODE)(P.87)”, the knobs work in CATCH mode, regardless of the settings.
	DIRECT	When you move a knob, the control data (current position) is always outputted.
EFX Knob Mode	CATCH	This sets how the values change when you move the knobs. When you move a knob, control data is only outputted when the position of the knob reaches or “catches up” to the value of its internal parameter.
	DIRECT	When you move a knob, the control data (current position) is always outputted.
	Manual	When you switch effects, control data corresponding to the position of the knob is outputted.
Load Project	Last	This sets the project that loads when the unit starts up. Loads the project that was used right before the power was last turned off.
	1-16	Loads a specified project.
Sub Pad Mode	Retrig	This sets the functionality of the [SUB PAD] button in sample mode. Retriggers the current pad (plays its sound again).
	SkipBack	Switches to skip-back mode.
Auto Trig Level	1-10	Sets the level at which note input is detected (the level at which sampling automatically starts, and the level at which recording to the skip-back memory begins).
Scrn Saver Time	1, 5, 10 (min)	Sets the time before the screen saver starts (in minutes).
Scrn Saver Type	OldRave, Naminori	Selects the type of screen saver.
	Custom	When you select “Custom”, you can use an image file that you’ve imported as the screen image for the screen saver (Customizing the Screen Saver (P.104)).
	Disp Off	Select “Disp Off” to turn off the display.
BPM Auto Dtct	ON, OFF	When this is set to “ON”, the tempo (BPM) is automatically detected when you import a sample.
BPM Detect Range	100-199, 80-159, 70-139, 50-99	Selects the range at which the tempo (BPM) of a sample is automatically detected.
Pad Mute		When Pad Mute is on, this selects whether to monitor the muted samples.
	Mst+Phn	Muted samples are not outputted to any jack.
	Master	Muted samples can be output (monitored) from the PHONES jack. In this case, no effects are applied.
PTN Change Mode	MKII	This sets how the samples play back when switching between patterns during pattern playback. Sample playback stops when the pattern changes.
	SX	Sample playback continues when the pattern changes.
Pop-up Time	Normal, Short, OFF	Sets how long the popup screens are displayed. Set this to “Short” to make the popup screens display for a shorter time than the “Normal” setting. Set this to “OFF” if you don’t want popups to display.
SBS Time		Sets the recording time for skip-back memory.

	Def	Recording time: 25 sec (max.)
	Long	Recording time: 40 sec (max.)
Reverse Type	This selects the point (time) at which reverse playback begins when you press the [REVERSE] button during sample playback.	
	404	Starts reverse playback at the sample's end point. This works the same as the SP-404SX.
	303	Starts reverse playback immediately from the playback position of the current sample. This works the same as the SP-303.
USB IN	This selects where the audio signal input from the USB port is sent.	
	LINE IN	Mixes the USB audio signal with the audio signal from the LINE IN jacks.
	MIX OUT	Mixes the USB audio signal with the MIXER output, without going through the INPUT FX or BUS FX.
DJ mode TS type	This lets you change how the audio is processed when changing the playback speed of a sample in DJ mode.	
	VINYL	Changes the playback speed and pitch at the same time, like an analog record.
	BACKING	Independently controls the playback speed and pitch. Processes the sound as appropriate for musical instruments whose sounds have a noticeable decay.
	ENSEMBLE	Independently controls the playback speed and pitch. Processes the sound as appropriate for musical instruments that have a sustaining sound.
Bend Sens (DJ)	10–200	Sets how quickly the pitch of a sample changes when you press the [BEND-] and [BEND+] pads.
FileSystem	Selects the character code for filenames that can be recognized by this unit when you import a sample.	
	<ul style="list-style-type: none"> The unit must be restarted once you've changed the settings and pressed the [EXIT] button to exit the SYSTEM screen. 	
	Multi-Byte	Letters, numbers, symbols, double-byte characters (kanji, hiragana, katakana) <ul style="list-style-type: none"> This lets the unit recognize and import files with filename that use double-byte and similar characters. Note that this unit doesn't correctly display double-byte characters, and these characters appear garbled.
	Latin1	Letters, numbers, symbols <ul style="list-style-type: none"> With this setting, files with double-byte characters in their filenames can't be recognized by this unit.

CLICK



Parameter	Value	Explanation
Output Assign	OFF, ON	When this is set to ON, the metronome sound is output from the LINE OUT jacks and from the USB port.
Click Level	1–5	Sets the volume of the metronome.
Metronome:REC	OFF, ON	When this is ON, the metronome sound is output while you are sampling or resampling.
Metronome:PTH	OFF, ON	When this is ON, the metronome sound is output when a pattern is being recorded.
Count-In:REC	This selects how sampling or resampling starts.	
	OFF	Sampling or resampling starts at the same time that you press the [REC] button.
	1 MEAS, 2 MEAS	When you press the [REC] button, a count-in begins one or two measures before where sampling or resampling begins.
	WAIT	Sampling or resampling starts when you press a pad to play back a sample, or when audio is detected from an external device.
Count-In:PTH	This selects how pattern recording begins.	
	OFF	Pattern recording starts at the same time that you press the [REC] button.
	1 MEAS, 2 MEAS	When you press the [REC] button, a count-in of one or two measures begins before pattern recording starts.
	WAIT	Pattern recording starts when you press a pad to play back a sample, or when audio is detected from an external device.

MIDI

GENERAL / CLICK / MIDI V G 13 / 5	
MIDI Sync	Auto
MIDI Sync Out	OFF
SEQ Note Out	ON
SYNC Delay	2ms
Bend SYNC(DJ)	ON
PAD Note Out	ON

Parameter	Value	Explanation
MIDI Sync	Auto	Specifies the tempo source. The tempo automatically synchronizes to the MIDI clocks if MIDI clocks are input via the MIDI IN connector or the USB port.
	Internal	The tempo specified on this unit is used.
	MIDI	The tempo synchronizes to the MIDI clocks received via the MIDI IN connector.
	USB	The tempo synchronizes to the MIDI clocks received via the USB port.
MIDI Sync Out	OFF, ON	When this is ON, clocks, start and stop are transmitted to the device connected to this unit's MIDI OUT connector.
SEQ Note Out	OFF, ON	When this is set to "ON", the note number corresponding to the pattern (pad) is output via the MIDI OUT connector when the pattern plays back.
SYNC Delay	0–20ms	Adjust this if there is a delay (latency) in sound between your external MIDI device and this unit. Larger values make this unit play back at a more delayed timing. When this is set to "0", this unit plays and outputs MIDI messages with the same timing.
Bend SYNC(DJ)	OFF	This sets how the MIDI clock output from this unit changes when you press the [BEND-] or [BEND+] pads to change the playback speed of this unit. MIDI clocks are output at a fixed rate.
	ON	MIDI clocks outputted from this unit are synchronized with this unit's playback speed. With this setting, the tempo of MIDI devices connected externally changes in time with the playback speed of this unit. <ul style="list-style-type: none"> If you press the [BEND-] [BEND+] pads while holding down the [REMAIN] button, the MIDI clocks do not change (the effect is the same as the OFF setting).
PAD Note Out	OFF, ON	When this is set to "ON", note numbers corresponding to the pads are output via the MIDI OUT connector when you play the pads.
Soft Through	OFF, ON	If this is "ON", MIDI messages that are input to the MIDI IN connector are output to the MIDI OUT connector.
USB-MIDI Thru	OFF, ON	When this is "ON", MIDI signals that are input via the USB port are output to the MIDI OUT connector. MIDI signals that are inputted via the MIDI IN connector are also outputted to the USB port. The inputted MIDI signals are also transmitted to the internal sound module at that time.
PC Rx	OFF, ON	When this is ON, program change messages are received.
MIDI Mode	A, B	Changes the note number assignment according to the mode you've selected. For details, refer to "MIDI Note Map(P.151)."
Pad MIDI Channels	1/2, 2/3–	Sets the offset value for the MIDI channel.
	9/10, 10/11	This setting is enabled when "MIDI Mode" is set to "B".
Note offset	-11–35	Sets the offset value for the note number. This setting is enabled when "MIDI Mode" is set to "B".

GAIN

/ CLICK / MIDI / GAIN V 11 / 5	
Attenuator	OFF
Noise Gate	-12dB
Line Out	0dB
Phones Out	0dB
USB Out	0dB
Anti Feedback	OFF

Parameter	Value	Explanation
Attenuator	OFF, ON	When this is ON, the gain of the audio input from the LINE IN jacks is lowered. Turn the Attenuator on when the LINE IN input seems to be distorting.
Noise Gate	OFF	Reduces the noise floor in the signal input from the LINE IN and INPUT jacks. The noise gate is not used.
	-9dB, -12dB, -18dB	Reduces the noise floor at the specified level.
	-Inf	Reduces the noise floor to the bare minimum.
Anti Feedback	OFF, ON	When this is "ON", the anti-feedback function is enabled for the mic input. This helps prevent mic feedback.
LINE OUT	0, +6, +12 (dB)	Sets the gain of the audio output from the LINE OUT jacks.
PHONES OUT	-18, -12, -6, 0, +6, +12 (dB)	Sets the gain of the audio output from the PHONES OUT jacks.
USB OUT	-24, -12, 0 (dB)	Sets the gain of the audio output from the USB port.

VERSION



Displays the version of this unit.

PAD SET

TRIGGER



Parameter	Value	Explanation
Curve Type	Lin	Sets how the volume changes according to how hard you strike a pad. This is the standard setting. This produces the most natural balance between playing dynamics and volume change.
	Exp	Compared to "Lin", playing strongly produces a greater change in volume.
	Log	Compared to "Lin", playing softly produces a greater change in volume.
	Fix	Sets the volume at a fixed level of 127.
Threshold	1–100	This sets the minimum sensitivity of the pads, at which the trigger signal is received only when a pad is struck with at least a certain amount of force (velocity). This can be used to prevent a pad from sounding due to vibrations from other pads.
Gain	0–100	The sensitivity is adjusted with the curve as-is. The larger the value, the greater the sensitivity is when playing the pads.
Trig Span	1–10	Adjusts the sensitivity of the pads to repeated strikes. With lower values, the pads detect repeated strikes within a shorter time interval. Set this value higher if you don't want the pad to accidentally detect repeated strikes.

LED



Parameter	Value	Explanation
LED Brightness	1–10	Sets the brightness of the indicators on the buttons and pads. This sets the brightness when the buttons or pads are highlighted.
LED Glow	1–10	Sets the brightness of the indicators on the buttons and pads. This sets the brightness when the buttons or pads are not highlighted.
Pad LED Mode	BUS	This selects the color of the pad illumination. In this mode, the pad colors change according to the bus through which the sample audio is sent.
	PAD	The pads light up in the color set in "BUS COLOR". The pads light up in the color set in "PAD COLOR".

BUS COLOR

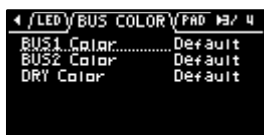

Parameter	Value	Explanation
-----------	-------	-------------

BUS1 Color	Default, 1–127,	Changes the pad color for each bus through which sample audio is sent. This can be set for BUS 1, BUS 2 and DRY respectively. This is enabled when Pad LED Mode is “BUS”.
BUS2 Color	White	
DRY Color		
		<ul style="list-style-type: none"> Hold down the [SHIFT] button and turn the [VALUE] knob to change the value in steps of 10.

PAD COLOR

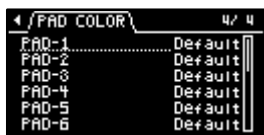

Parameter	Value	Explanation
PAD-1–PAD-16	Default, 1–127, White	Specifies the colors of individual pads. This is enabled when Pad LED Mode is “PAD”, and when a sample is either playing back or stopped while in sample mode.

EFX SET

FAVORITE



Parameter	Value	Explanation
Routing	TYPE A, TYPE B	Selects the routing (connection) of the bus to which effects are assigned. “Configuring the Effect Routing(P.108)”
FAVORITE	1–16	Selects the combination of effects assigned to BUS 3 and BUS 4. “Changing the Effects Assigned to BUS 3 and BUS 4(P.109)”

BUS 3, BUS 4

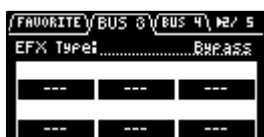

Parameter	Value	Explanation
EFX TYPE	Bypass, 303 VinylSim, 404 VinylSim, Cassette Sim, Lo-fi, Downer, Compressor, Equalizer, Isolator, Super Filter, Filter+Drive, WrmSaturator, Overdrive, Distortion, Crusher, Ring Mod, SBF, Resonator, Hyper-Reso, Chromatic PS, Reverb, Ha-Dou, Zan-Zou, Sync Delay, TimeCtrlDly, Ko-Da-Ma, Tape Echo, Chorus, JUNO Chorus, Flanger, Phaser, Wah, Slicer, Tremolo/Pan, To-Gu-Ro, DJFX Looper, Scatter, SX Reverb, SX Delay, Cloud Delay	Selects the effects assigned to BUS 3 or BUS 4. For details on the parameters of each effect, refer to “MFX List(P.129)” .

DIRECT



Parameter	Value	Explanation
-----------	-------	-------------

Direct FX1–
Direct FX5

Filter+Drive, Resonator, Sync Delay, Isolator, DJFX Looper, Scatter, Downer, Ha-Dou, Ko-Da-Ma, Zan-Zou, To-Gu-Ro, SBF, Stopper, Tape Echo, TimeCtrlDly, Super Filter, WrmSaturator, 303 VinylSim, 404 VinylSim, Cassette Sim, Lo-fi, Reverb, Chorus, JUNO Chorus, Flanger, Phaser, Wah, Slicer, Tremolo/Pan, Chromatic PS, Hyper-Reso, Ring Mod, Crusher, Overdrive, Distortion, Equalizer, Compressor, SX Reverb, SX Delay, Cloud Delay, Back Spin

You can assign the effects you like to the effect buttons on the top panel. For details on the parameters of each effect, refer to “[MFX List\(P.129\)](#)”.

OTHER



Parameter	Value	Explanation
Mute Bus	This individually selects the bus to mute with MUTE BUS. ALL	Both BUS 1 and BUS 2 are muted.
	BUS	Only the bus selected with the [BUS FX] button is muted.
Input FX	Bypass, Auto Pitch (*), Vocoder (*), Gt Amp Sim (*), Harmony (*), Chorus, JUNO Chorus, Reverb, TimeCtrlDly, Chromatic PS, Downer, WrmSaturator, 303 VinylSim, 404 VinylSim, Cassette Sim, Lo-fi, Equalizer, Compressor Effects marked with an (*) are for INPUT FX only.	You can apply effects to the audio that's inputted to this unit. For details on the parameters of each effect, refer to “ MFX List(P.129) ”.
Input Bus	You can set the bus to which the playback audio signals coming into the INPUT jack are sent (meaning which effects are used). DRY	The signal is not sent to BUS 1, BUS 2 (the BUS 1 and BUS 2 effects are not used).
	BUS1, BUS2	The signal is sent to BUS 1 or BUS 2. The effects set for BUS 1 and BUS 2 are used.
DRY Routing	This sets the routing for audio sent to the DRY bus. DRY	Audio is not sent through BUS 1–BUS 4 (no effects are applied).
	BUS3	Audio is inserted just before BUS 3. The BUS 3 and BUS 4 effects are applied.
MFX TOP	Scatter, Downer, Ha-Dou, Ko-Da-Ma, Zan-Zou, To-Gu-Ro, SBF, Stopper, Tape Echo, TimeCtrlDly, Super Filter, WrmSaturator, 303 VinylSim, 404 VinylSim, Cassette Sim, Lo-fi, Reverb, Chorus, JUNO Chorus, Flanger, Phaser, Wah, Slicer, Tremolo/Pan, Chromatic PS, Hyper-Reso, Ring Mod, Crusher, Overdrive, Distortion, Equalizer, Compressor, SX Reverb, SX Delay, Cloud Delay, Back Spin	Sets the MFX that's used when this unit is turned on. For details on the parameters of each effect, refer to “ MFX List(P.129) ”.

MFX List

Filter+Drive

This is a filter with overdrive.

It cuts the specified frequencies and adds distortion.

Parameter	Value	Explanation
CUTOFF	20–16000 (Hz)	Sets the cutoff frequency range in which the filter works.
RESONANCE	0–100	Adjusts the filter's resonance level. The larger the value, the more that the frequency range set in CUTOFF is emphasized.
DRIVE	0–100	Adds distortion.
FLT TYPE	Sets the type of filter.	
	HPF	Cuts off the low frequencies.
	LPF	Cuts off the high frequencies.
LOW FREQ	20–16000 (Hz)	Adjusts the frequency range that's boosted or cut by the LOW GAIN parameter.
LOW GAIN	-24–24 (dB)	Adjusts the amount of boost/cut applied to the frequency range that's set in LOW FREQ.

Resonator

This effect uses "Karplus-Strong synthesis", which is often used in physical modeling of sounds.

This lets you alter the sound with a maximum of six "resonators" that match different keys or chords.

Parameter	Value	Explanation
ROOT	C1–G9	Sets the reference pitch (root note).
BRIGHT	0–100	Adjusts the tonal brightness.
FEEDBACK	0–99 (%)	Adjusts the amount of feedback for the effect.
CHORD	Root, Oct, UpDn, P5, m3, m5, m7, m7oct, m0, m11, M3, M5, M7, M7oct, M9, M11	Sets the composite notes (chord) to resonate.
PANNING	0–100	Sets the panning for the resonator.
ENV MOD	0–100	Larger values increase the amount of feedback according to the input level.

Sync Delay

Gives an echo effect in sync with the tempo.

Parameter	Value	Explanation
TIME	1/32, 1/16T, 1/32D, 1/16, 1/8T, 1/16D, 1/8, 1/4T, 1/8D, 1/4, 1/2T, 1/4D, 1/2, 1/1T, 1/2D, 1/1	Sets the sound delay time.
FEEDBACK	0–99 (%)	Adjusts the amount of feedback for the effect.
LEVEL	0–100	Adjusts the volume of the effect sound.
L DAMP F	FLAT, 80, 100, 125, 160, 200, 250, 315, 400, 500, 630, 800 (Hz)	Sets the frequency range that is attenuated each time the delay repeats.
H DAMP F	630, 800, 1000, 1250, 1600, 2000, 2500, 3150, 4000, 5000, 6300, 8000, 10000, 12500, FLAT (Hz)	

Isolator

This effect lets you cut off sounds in a specified frequency range.

Parameter	Value	Explanation
LOW	-INF, -41.87–+12 (dB)	Adjusts the amount of boost/cut in the low-frequency range.
MID	-INF, -41.87–+12 (dB)	Adjusts the amount of boost/cut in the mid-frequency range.
HIGH	-INF, -41.87–+12 (dB)	Adjusts the amount of boost/cut in the high-frequency range.

DJFX Looper

This effect loops the sound in short cycles.

You can vary the playback direction and playback speed of the input sound to get a turntable-type effect.

Parameter	Value	Explanation
LENGTH	0.230–0.012 (sec)	Sets the length of the loop.
SPEED	-100–100	Sets the playback direction and playback speed. The loop plays backward when this is set to a negative value, stops when this is set to zero, and plays forward when this is set to a positive value.
LOOP SW	OFF, ON	Turn this ON while a sound is playing to make the sound play back in a loop, at a length specified by the LENGTH parameter. Turn this OFF to disable the loop.

Scatter

This effect swaps the sound played back by a loop in steps, altering its playback direction and gate length. This gives you the loop playback a digital groove feeling.

Parameter	Value	Explanation
TYPE	1–10	Sets the scatter type.
DEPTH	10, 20, 30, 40, 50, 60, 70, 80, 90, 100	Adjusts the scatter depth.
SCATTER	OFF, ON	Switches the scatter effect on/off.
SPEED	SINGLE, DOUBLE	Sets the scatter speed.

Downer

Cyclically slows down the audio playback speed.

Parameter	Value	Explanation
DEPTH	0–100	Sets how much the playback speed should be slowed down.
RATE	1/32, 1/16, 1/8, 1/4, 1/2, 1, 2	Sets the period at which the playback speed is changed.
FILTER	0–100	Attenuates the high-frequency range.
PITCH	OFF, ON	When this is turned ON, pitches that were lowered due to the change in speed are converted to their original pitch.
RESONANCE	0–100	Adjusts the filter's resonance level. Increasing the value further emphasizes the effect, for a more unusual sound.

Ha-Dou

This effect generates a wave-like sound based on the input audio.

Parameter	Value	Explanation
MOD DEPTH	0–100	Adjusts the depth of the effect sound.
TIME	0–100	Sets the length of the effect sound.
LEVEL	0–100	Adjusts the volume of the effect sound.
LOW CUT	FLAT, 20, 25, 31, 40, 50, 63, 80, 100, 125, 160, 200, 250, 315, 400, 500, 630, 800 (Hz)	Sets the frequency range at which the effect sound is attenuated.
HIGH CUT	630, 800, 1000, 1250, 1600, 2000, 2500, 3150, 4000, 5000, 6300, 8000, 10000, 12500, FLAT (Hz)	
PRE DELAY	0–100	Sets the time it takes for the effect to sound.

Ko-Da-Ma

This creates a reverberating audio effect.

Parameter	Value	Explanation
TIME	1/32, 1/16T, 1/32D, 1/16, 1/8T, 1/16D, 1/8, 1/4T, 1/8D, 1/4, 1/2T, 1/4D, 1/2, 1/1T, 1/2D, 1/1	Sets how much the effect sound is delayed.
FEEDBACK	0–99 (%)	Adjusts how much the effect sound is repeated.
SEND	0–100	Adjusts the volume of sound sent to the effect.
L DAMP F	FLAT, 80, 100, 125, 160, 200, 250, 315, 400, 500, 630, 800 (Hz)	Sets the frequency range that is attenuated each time the delay repeats.
H DAMP F	630, 800, 1000, 1250, 1600, 2000, 2500, 3150, 4000, 5000, 6300, 8000, 10000, 12500, FLAT (Hz)	
MODE	SINGLE, PAN	When this is set to “SINGLE”, the effect sound comes from the center; and when this is set to “PAN”, the effect sound is heard on the left and the right.

Zan-Zou

For left and right sounds, this effect applies delay to the negative phase of the sound. This gives the lingering effect of a sonic “afterimage”.

The effect works for stereo sound, and does not have any effect on mono sound.

Parameter	Value	Explanation
TIME	1–100 (when the SYNC parameter is OFF) 1/32, 1/16T, 1/32D, 1/16, 1/8T, 1/16D, 1/8, 1/4T, 1/8D, 1/4, 1/2T, 1/4D, 1/2, 1/1T, 1/2D, 1/1 (when the SYNC parameter is ON)	Sets the sound delay time.
FEEDBACK	0–99	Adjusts the amount of feedback for the effect.
HF DAMP	200, 250, 315, 400, 500, 630, 800, 1000, 1250, 1600, 2000, 2500, 3150, 4000, 5000, 6300, 8000, OFF (Hz)	Sets the frequency range at which the effect sound is attenuated (how clearly defined the afterimage sounds).
LEVEL	0–100	Adjusts the volume of the effect sound.
MODE	2TAP, 3TAP, 4TAP	Sets how the effect sound lingers.
SYNC	OFF, ON	When this is ON, the effect sound synchronizes with the tempo.

To-Gu-Ro

This gives the sound an undulating effect, based on the image of a coiled-up snake.

Parameter	Value	Explanation
DEPTH	0–100	Adjusts how much the playback speed should be slowed down.
RATE	0–100 (when the SYNC parameter is OFF) 1/128, 1/64, 1/32, 1/16, 1/8, 1/4, 1/2, 1/1, 2/1 (when the SYNC parameter is ON)	Sets the period at which the playback speed is lowered.
RESONANCE	0–100	Adjusts the filter’s resonance level. Increasing the value further emphasizes the effect, for a more unusual sound.
FLT MOD	0–100	Attenuates the high-frequency range according to the playback speed.
AMP MOD	0–100	Attenuates the volume according to the playback speed.
SYNC	OFF, ON	When this is ON, the effect sound synchronizes with the tempo.

SBF

A sideband filter that lets specific frequency components pass through.

Parameter	Value	Explanation
INTERVAL	0–100	Sets the band interval. Larger values produce wider band intervals, and the frequency of each band increases.
WIDTH	0–100	Sets the bandwidth. Larger values produce a narrower bandwidth, which further isolates the specific frequency components that pass through the filter.
BALANCE	100-0–0-100 (%)	Adjusts the volume balance between dry (the original sound) and effect sound.
TYPE	SBF1, SBF2, SBF3, SBF4, SBF5, SBF6	Sets the range in which the filter works.
GAIN	-INF, -52.3–+10.0 (dB)	Adjusts the volume of the effect sound.

Stopper

This effect lowers the sample playback speed, reproducing the sound of a turntable stopping.

Parameter	Value	Explanation
DEPTH	0–100	Adjusts how much the playback speed should be slowed down.
RATE	1/128, 1/64, 1/32, 1/16, 1/8, 1/4, 1/2, 1, 2	Sets the period at which the playback speed is changed.
RESONANCE	0–100	Adjusts the filter's resonance level. Increasing the value further emphasizes the effect, for a more unusual sound.
FLT MOD	0–100	Attenuates the high-frequency range according to the playback speed.
AMP MOD	0–100	Lowers the volume according to the playback speed.

Tape Echo

This is a virtual tape echo effect that gives a realistic tape delay sound.

The effect simulates the tape echo section of a Roland RE-201 Space Echo.

Parameter	Value	Explanation
TIME	10–800 (ms)	Sets the tape speed. Larger values make the tape speed slower, which creates a longer interval between delay sounds.
FEEDBACK	0–99	Adjusts the volume of the delay repeat sound.
LEVEL	0–100	Adjusts the volume of the effect sound.
MODE	S, M, L, S+M, S+L, M+L, S+M+L	Selects the combination of playback heads to use.
W/F RATE	0–100	Sets the speed of wow/flutter (the complex variation in pitch caused by tape wear and rotational irregularity).
W/F DEPTH	0–100	Sets the depth of wow/flutter.

TimeCtrlDly

This is a delay in which the delay time can be varied smoothly.

Parameter	Value	Explanation
TIME	0–100	Sets the sound delay time.
FEEDBACK	0–99	Adjusts the amount of feedback for the effect.
LEVEL	0–100	Sets the volume of the effect sound.
L DAMP F	FLAT, 80, 100, 125, 160, 200, 250, 315, 400, 500, 630, 800 (Hz)	Sets the frequency range that is attenuated each time the delay repeats.
H DAMP F	630, 800, 1000, 1250, 1600, 2000, 2500, 3150, 4000, 5000, 6300, 8000, 10000, 12500, FLAT (Hz)	

SYNC	OFF, ON
------	---------

When this is ON, the effect sound synchronizes with the tempo.

Super Filter

This is a filter with an extremely sharp slope (attenuation characteristics). The cutoff frequency can be varied cyclically.

Parameter	Value	Explanation
CUTOFF	0–100	Sets the frequency range in which the filter works (the cutoff frequency). Higher values increase the frequency range.
RESONANCE	0–100	Adjusts the filter's resonance level. The larger the value, the more that the frequency range set in CUTOFF is emphasized.
FLT TYPE	Sets the filter type.	
	LPF	A low-pass filter. This filter lets frequencies pass through that are higher than the frequency range set in CUTOFF.
	BPF	A band-pass filter. This filter lets frequencies pass through that are near the frequency range set in CUTOFF.
HPF	A high-pass filter. This filter lets frequencies pass through that are higher than the frequency range set in CUTOFF.	
DEPTH	0–100	Sets the depth of the effect.
RATE	0–100	Sets the cycle (period) of the effect.
SYNC	OFF, ON	When this is ON, the effect sound synchronizes with the tempo.

WrmSaturator

This is a saturator effect with a characteristic warm sound.

NOTE

This effect may output a very loud sound, depending on how the parameters are set. Use caution not to raise the values too much.

Parameter	Value	Explanation
DRIVE	0–48 (dB)	Adjusts the strength of the distortion.
Eq LOW	-24–24 (dB)	Adjusts the amount of boost/cut for the low-frequency range.
Eq HIGH	-24–24 (dB)	Adjusts the amount of boost/cut for the high-frequency range.
LEVEL	0–100	Adjusts the volume of the effect sound.

303 VinylSim

This effect models the Vinyl Sim effect of the SP-303. The effect simulates the sound of an analog record playing.

Parameter	Value	Explanation
COMP	0–100	Sets the compression feel, a unique part of the analog record's sound.
NOISE	0–100	Adjusts the volume of the noise.
WOW FLUT	0–100	Sets the inconsistencies (wow/flutter) heard when the analog record "rotates".
LEVEL	0–100	Adjusts the volume of the effect sound.

404 VinylSim

This effect models the Vinyl Sim effect of the SP-404SX. The effect simulates the sound of an analog record playing.

Parameter	Value	Explanation
FREQUENCY	0–100	Sets the frequency characteristics of the playback system.
NOISE	0–100	Adjusts the volume of the noise.
WOW FLUT	0–100	Sets the inconsistencies (wow/flutter) heard when the analog record "rotates".

Cassette Sim

This effect simulates the sound of a cassette tape playing.

Parameter	Value	Explanation
TONE	0–100	Sets the tone.
HISS	0–100	Adjusts the volume of the noise.
AGE	0–60 (years)	Sets how many years the cassette tape has deteriorated.
DRIVE	0–100	Adjusts the amount of distortion.
WOW FLUT	0–100	Sets the inconsistencies (wow/flutter) heard when the cassette tape plays back.
CATCH	0–100	Sets how much the cassette tape has stretched out.

Lo-fi

Degrades the tonal character.

Parameter	Value	Explanation
PRE FILT	1–6	Sets the type of pre-filter (the filter that the sound passes through before effects are applied).
LOFI TYPE	1–9	Larger settings cause more tonal degradation.
TONE	-100–100	Sets the tone. Larger settings emphasize the high-frequency range. Smaller settings emphasize the low-frequency range.
CUTOFF	200, 250, 315, 400, 500, 630, 800, 1000, 1250, 1600, 2000, 2500, 3150, 4000, 5000, 6300, 8000 (Hz)	Sets the frequency range in which the post-filter (the filter that the sound passes through after effects are applied) works.
BALANCE	100–0–0–100	Adjusts the volume balance between dry (the original sound) and effect sound.
LEVEL	0–100	Adjusts the volume of the effect sound.

NOTE

This effect may output a very loud sound, depending on how the parameters are set. Use caution not to raise the values too much.

Reverb

Adds reverberation to the sound.

Parameter	Value	Explanation
TYPE	AMBI, ROOM, HALL1, HALL2	Sets the type of reverb.
TIME	0–100	Sets the reverb time.
LEVEL	0–100	Adjusts the volume of the effect sound.
LOW CUT	FLAT, 20–800 (Hz)	Sets the frequency range at which the effect sound is attenuated.
HIGH CUT	630–12500, FLAT (Hz)	
PRE DELAY	0–100 (ms)	Sets the time before the effect sound is output.

Chorus

Adds spaciousness and richness to the sound.

Parameter	Value	Explanation
DEPTH	0–100	Sets the depth of the effect sound.
RATE	0.33–2.30 (sec)	Sets the cycle (period) of the effect sound.
BALANCE	100–0–0–100 (%)	Adjusts the volume balance between dry (the original sound) and effect sound.
EQ LOW	-15–15 (dB)	Adjusts the amount of boost/cut of the low-frequency range.
EQ HIGH	-15–15 (dB)	Adjusts the amount of boost/cut of the high-frequency range.
LEVEL	0–100	Adjusts the volume of the effect sound.

JUNO Chorus

This effect models the chorus section of the Roland JUNO-106 and JX series.

Parameter	Value	Explanation
-----------	-------	-------------

MODE	JUNO 1, JUNO 2, JUNO12, JX-1 1, JX-1 2	Sets the type of effect.
NOISE	0–100	Adjusts the volume of noise generated by the effect.
BALANCE	100-0-0-100 (%)	Adjusts the volume balance between dry (the original sound) and effect sound.

Flanger

This effect creates modulation like a jet airplane taking off and landing.

Parameter	Value	Explanation
DEPTH	0–100	Sets the depth of the effect sound.
RATE	0–100 (when the SYNC parameter is OFF) 4.000–0.016 (bars; when the SYNC parameter is ON)	Sets the cycle (period) of the effect sound.
MANUAL	0–100	Sets the frequency range in which the effect is applied. Smaller values reduce the flanging effect in the low end.
RESONANCE	0–100	Adjusts the filter's resonance level. Increasing the value further emphasizes the effect, for a more unusual sound.
BALANCE	100-0-0-100 (%)	Adjusts the volume balance between dry (the original sound) and effect sound.
SYNC	OFF, ON	When this is ON, the effect sound synchronizes with the tempo.

Phaser

This effect creates modulation by adding a phase-shifted sound.

Parameter	Value	Explanation
DEPTH	0–100	Sets the depth of the effect sound.
RATE	0–100 (when the SYNC parameter is OFF) 4.000–0.016 (bars; when the SYNC parameter is ON)	Sets the cycle (period) of the effect sound.
MANUAL	0–100	Sets the frequency range in which the effect is applied. Larger values reduce the phasing effect in the low end.
RESONANCE	0–100	Adjusts the filter's resonance level. Increasing the value further emphasizes the effect, for a more unusual sound.
BALANCE	100-0-0-100 (%)	Adjusts the volume balance between dry (the original sound) and effect sound.
SYNC	OFF, ON	When this is ON, the effect sound synchronizes with the tempo.

Wah

This effect gives a wah-wah sound, by cyclically changing the tone.

Parameter	Value	Explanation
PEAK	0–100	Larger values narrow the frequency range at which the effect is applied.
RATE	0–100 (when the SYNC parameter is OFF) 1.000–0.010 (bars; when the SYNC parameter is ON)	Sets the cycle (period) of the effect.
MANUAL	0–100	Sets the frequency range in which the effect is applied.
DEPTH	0–100	Sets the depth of the effect.
FLT TYPE	Sets the filter type.	
	LPF	Applies the effect over a wide frequency range.
	BPF	Applies the effect over a narrow frequency range.
SYNC	OFF, ON	When this is ON, the effect sound synchronizes with the tempo.

Slicer

This slices the sound up into small pieces, creating the impression that a backing phrase is being played.

This slices up the sound at certain intervals into 16 parts (16 steps), breaking the sound into a rhythm that follows the sequence pattern (a pattern used for slicing up the sound). This is effective when used with sustaining sounds.

Parameter	Value	Explanation
PATTERN	1–32	Sets the sequence pattern.
SPEED	0–100 (when the SYNC parameter is OFF) 2/1 to 1/64T (bars; when the SYNC parameter is ON)	Sets the period over which the sequence pattern repeats.
DEPTH	0–100	Sets the slicing depth. Larger settings make the slicing effect more prominent.
SHUFFLE	0–100	Larger settings delay the timing of even-numbered steps (2, 4...).
MODE	Sets how the volume changes when the next step sounds.	
	LEGATO	The volume is not changed between steps.
	SLASH	The volume is reset to zero before the next step sounds (at the boundary between steps).
SYNC	OFF, ON	When this is ON, the effect sound synchronizes with the tempo.

Tremolo/Pan

Cyclically varies the volume or panning.

Parameter	Value	Explanation
DEPTH	0–100	Sets the depth of the effect.
RATE	0–100 (when the SYNC parameter is OFF) 1.000–0.010 (when the SYNC parameter is ON)	Sets the cycle (period) of the effect.
TYPE	Sets the type of effect.	
	TRE	Cyclically changes the volume (tremolo).
	PAN	Cyclically changes the panning.
WAVE	Sets how the effect modulates the sound.	
	TRI	Triangle wave
	SQR	Square wave
	SIN	Sine wave
	SAW1, SAW2	Sawtooth wave
	TRP	Trapezoidal wave
SYNC	OFF, ON	When this is ON, the effect sound synchronizes with the tempo.

Chromatic PS

A two-voice pitch shifter that changes the pitch in semitone steps.

Parameter	Value	Explanation
PITCH1, PITCH2	-24–12 (semi)	Adjusts the amount that PITCH1 or PITCH2 is pitch-shifted.
BALANCE	100-0-0-100 (%)	Adjusts the volume balance between dry (the original sound) and effect sound.
PAN1, PAN2	L50–R50	Sets the panning of PITCH1 or PITCH2.

Hyper-Reso

This is a resonator effect that is adjusted to make creating melodies and bass lines easier.

Parameter	Value	Explanation
NOTE	-17– -1, 1–18	Sets which note in the chromatic scale should resonate, counting from the root of the SCALE value.

SPREAD	UNISON, TINY, SMALL, MEDIUM, HUGE	Sets the octave of the resonator.
CHARACTER	0–100	Adjusts the brightness and detuning of the sound.
SCALE	C maj–B maj, C min–B min	Sets the composite notes (chord) to resonate.
FEEDBACK	0–99 (%)	Adjusts the amount of feedback for the effect.
ENV MOD	0–100	Larger values increase the amount of feedback according to the input level.

Ring Mod

This effect alters the tonal character to make the sound more metallic.

Parameter	Value	Explanation
FREQUENCY	0–100	Sets the frequency range to which the effect is applied.
SENS	0–100	Adjusts the volume of the effect sound.
BALANCE	100–0–0–100 (%)	Adjusts the volume balance between dry (the original sound) and effect sound.
POLARITY	OFF, ON	Sets the direction in which the frequency modulation moves.
EQ LOW	-15–15 (dB)	Adjusts the amount of boost/cut of the low-frequency range.
EQ HIGH	-15–15 (dB)	Adjusts the amount of boost/cut of the high-frequency range.

Crusher

Produces a lo-fi effect.

Parameter	Value	Explanation
FILTER	331–15392 (Hz)	Sets the frequency range in which the pre-filter (the filter that the sound passes through before effects are applied) works.
RATE	0–100	Sets the sample rate of the effect. Larger values make the sample rate lower, for a more lo-fi sound.
BALANCE	100–0–0–100 (%)	Adjusts the volume balance between dry (the original sound) and effect sound.

Overdrive

Mildly distorts the sound.

Parameter	Value	Explanation
DRIVE	0–100	Adjusts the amount of distortion.
TONE	-100–100	Sets the tone. Larger settings emphasize the high-frequency range. Smaller settings emphasize the low-frequency range.
BALANCE	100–0–0–100 (%)	Adjusts the volume balance between dry (the original sound) and effect sound.
LEVEL	0–100	Adjusts the volume of the effect sound.

Distortion

Intensely distorts the sound.

Parameter	Value	Explanation
DRIVE	0–100	Adjusts the amount of distortion.
TONE	-100–100	Sets the tone. Larger settings emphasize the high-frequency range. Smaller settings emphasize the low-frequency range.
BALANCE	100–0–0–100 (%)	Adjusts the volume balance between dry (the original sound) and effect sound.
LEVEL	0–100	Adjusts the volume of the effect sound.

Equalizer

This is a three-band equalizer.

Parameter	Value	Explanation
LOW GAIN	-15–15 (dB)	Adjusts the amount of boost/cut of the low-frequency range.
MID GAIN	-15–15 (dB)	Adjusts the amount of boost/cut of the mid-frequency range.
HIGH GAIN	-15–15 (dB)	Adjusts the amount of boost/cut of the high-frequency range.
LOW FREQ	20, 25, 31, 40, 50, 63, 80, 100, 125, 160, 200, 250, 315, 400 (Hz)	Sets the low-frequency range.
Mid Freq	200, 250, 315, 400, 500, 630, 800, 1000, 1250, 1600, 2000, 2500, 3150, 4000, 5000, 6300, 8000 (Hz)	Sets the mid-frequency range.
HIGH FREQ	2000, 2500, 3150, 4000, 5000, 6300, 8000, 10000, 12500, 16000 (Hz)	Sets the high-frequency range.

Compressor

This effect reduces high volume levels while bringing up the level of quieter sounds, smoothing out any variations in overall volume.

Parameter	Value	Explanation
SUSTAIN	0–100	Sets how long the effect is applied to the decaying sound.
ATTACK	0–100	Sets how long it takes to reduce the volume when a high input level is detected.
RATIO	0–100	Sets the compression ratio.
LEVEL	0–100	Adjusts the volume of the effect sound.

NOTE

This effect may output a very loud sound, depending on how the parameters are set. Use caution not to raise the values too much.

SX Reverb

This adds reverberation to the sound.

As with the SP-404SX, you can adjust the volume balance between the dry (original) sound and the effect sound with this effect.

Parameter	Value	Explanation
TIME	0–100	Sets the reverb time.
TOPE	-12–+12	Adjusts the tonal character of the reverb.
BALANCE	100-0-0-100 (%)	Adjusts the volume balance between the dry (original) sound and effect sound.

SX Delay

Gives an echo effect in sync with the tempo.

As with the SP-404SX, you can adjust the volume balance between the dry (original) sound and the effect sound with this effect.

Parameter	Value	Explanation
TIME	1/32, 1/16T, 1/32D, 1/16, 1/8T, 1/16D, 1/8, 1/4T, 1/8D, 1/4, 1/2T, 1/4D, 1/2, 1/1T, 1/2D, 1/1	Sets the sound delay time.
FEEDBACK	0–99 (%)	Adjusts the amount of feedback for the effect.
BALANCE	100-0-0-100 (%)	Adjusts the volume balance between the dry (original) sound and effect sound.

Cloud Delay

Adds multiple delays to the dry sound, as well as reverberations for a thick “cloudy” effect.

Parameter	Value	Explanation
WINDOW	0–100	Adjusts the interval for the delayed sound. Larger settings produce a deeper reverberation.

PITCH	-12--+12	Adjusts the volume of the pitch shifter for the effect sound.
BALANCE	100-0-0-100 (%)	Adjusts the volume balance between the dry (original) sound and effect sound.
FEEDBACK	0-99 (%)	Adjusts the amount of feedback for the effect.
CLOUDY	0-100	Adjusts the thickness of the effect sound.
LO-FI	OFF, ON	When this is ON, the tonal character of the effect sound is degraded.

Back Spin

This gives the effect of spinning a record backwards.

Parameter	Value	Explanation
LENGTH	1/1, 1/2, 1/4, 1/8, 1/16	Sets the length of the back spin.
SPEED	0-100	Sets the speed of the back spin.
BACK SW	OFF, ON	If you turn this ON while a sound is playing, the back spin plays for a length of time specified by the LENGTH parameter. Turn this OFF to disable the back spin.
		<p>MEMO</p> <p>After switching to this effect, the sample must be played back (charged) for up to approximately three seconds. The BACK SW parameter blinks during charging.</p> 

Auto Pitch

Processes the human voice to create a variety of characters.

- * This is enabled with INPUT FX.

Parameter	Value	Explanation
PITCH	-100-100	Sets the pitch of the voice. You can change the pitch up and down one octave.
FORMANT	-100-100	Sets the formant of the voice. Lower settings give a more masculine vocal character, and higher settings give a more feminine vocal character.
BALANCE	100-0-0-100 (%)	Adjusts the volume balance between dry (the original sound) and effect sound.
AT PITCH	0-100	Adjusts the strength at which the pitch is corrected.
KEY	CHROMA, A, B ^b , B, C, D ^b , D, E ^b , E, F, G ^b , G, A ^b	Adjusts the key to which the pitch is corrected.
ROBOT	OFF, ON	When this is turned ON, the inputted voice is altered to a voice without inflection, staying at the same pitch.

Vocoder

Changes the voice to a vocoder voice.

- * This is enabled with INPUT FX.

Parameter	Value	Explanation
NOTE	-17- -1, 1-18	Sets which note in the chromatic scale should sound, counting from the root of the SCALE value. The scale and chord structure that is used depends on the SCALE and CHORD settings.
		<p>MEMO</p> <p>The NOTE value can be controlled via note messages from a MIDI keyboard connected to the MIDI IN connector, a computer connected via USB, a DAW app running on an iOS device and so on. At that time, you can send pitch bend messages to continuously change the pitch.</p>

		For note messages (Note Number = 0–127) and pitch bend messages, set the MIDI channel on your external device to “11”.
FORMANT	-100–100	Adjusts the formant of the voice. Lower settings give a more masculine vocal character, and higher settings give a more feminine vocal character.
TONE	-100–100	Adjusts the brightness of the effect sound.
SCALE	C maj–B maj, C min–B min	Sets the scale to use and its root.
CHORD	Root, P5, Oct, UpDn, UpDnP5, 3rd, 5thUp, 5thDn, 7thUp, 7thDn	Sets the chord structure.
BALANCE	100-0-0-100	Adjusts the volume balance between dry (the original sound) and effect sound.

Harmony

This effect adds a harmony to your voice.

Parameter	Value	Explanation
PITCH	-100–100	Sets the pitch of the voice. You can change the pitch up and down one octave.
FORMANT	-100–100	Sets the formant of the voice. Lower settings give a more masculine vocal character, and higher settings give a more feminine vocal character.
BALANCE	100-0-0-100 (%)	Adjusts the volume balance between the dry (original) sound and effect sound.
AT PITCH	0–100	Adjusts the strength at which the pitch is corrected.
KEY	CHROMA, A, B ^b , B, C, D ^b , D, E ^b , E, F, G ^b , G, A ^b	Sets the key to which the pitch is adjusted and the harmonies are added.
HARMONY	Root, P5, Oct, UpDn, UpDnP5, 3rd, 5thUp, 5thDn, 7thUp, 7thDn	Sets the harmonization.

Gt Amp Sim

This effect models a guitar amplifier.

* This is enabled with INPUT FX.

Parameter	Value	Explanation
AMP TYPE	Selects the guitar amp type.	
	JC	Models the sound of a Roland JC-120.
	TWIN	Models a Fender Twin Reverb.
	BG	Models a lead guitar sound played using a MESA/Boogie combo amp.
	MATCH	Models a Matchless D/C-30.
	MS	Models a Marshall 1959.
SLDN	Models a Soldano SLO-100.	
DRIVE	0–100	Adjusts the volume and distortion of the amp.
LEVEL	0–100	Adjusts the volume of the effect sound.
BASS	-100–100	Adjusts the low-frequency tonal character.
MIDDLE	-100–100	Adjusts the midrange tonal character.
TREBLE	-100–100	Adjusts the high-frequency tonal character.

Control change messages and corresponding effects

You can use a control change message (CC#83) to select the effects.

The effects (selectable effects) corresponding to the respective CC#83 values are shown below.

BUS1 (MIDI ch 1), BUS2 (MIDI ch 2)

Value of CC#83	Effect name
0	(OFF)
1	Direct FX1
2	Direct FX2

3	Direct FX3
4	Direct FX4
5	Direct FX5
6	Scatter
7	Downer
8	Ha-Dou
9	Ko-Da-Ma
10	Zan-Zou
11	To-Gu-Ro
12	SBF
13	Stopper
14	Tape Echo
15	TimeCtrlDly
16	Super Filter
17	WrmSaturator
18	303 VinylSim
19	404 VinylSim
20	Cassette Sim
21	Lo-fi
22	Reverb
23	Chorus
24	JUNO Chorus
25	Flanger
26	Phaser
27	Wah
28	Slicer
29	Tremolo/Pan
30	Chromatic PS
31	Hyper-Reso
32	Ring Mod
33	Crusher
34	Overdrive
35	Distortion
36	Equalizer
37	Compressor
38	SX Reverb
39	SX Delay
40	Cloud Delay
41	Back Spin
42-127	-

BUS3 (MIDI ch 3), BUS4 (MIDI ch 4)

Value of CC#83	Effect name
0	(OFF)
1	303 VinylSim
2	404 VinylSim
3	Cassette Sim
4	Lo-fi
5	Downer
6	Compressor
7	Equalizer
8	Isolator
9	Super Filter
10	Filter+Drive
11	WrmSaturator
12	Overdrive
13	Distortion
14	Crusher
15	Ring Mod
16	SBF
17	Resonator
18	Hyper-Reso

19	Chromatic PS
20	Reverb
21	Ha-Dou
22	Zan-Zou
23	Sync Delay
24	TimeCtrlDly
25	Ko-Da-Ma
26	Tape Echo
27	Chorus
28	JUNO Chorus
29	Flanger
30	Phaser
31	Wah
32	Slicer
33	Tremolo/Pan
34	To-Gu-Ro
35	DJFX Looper
36	Scatter
37	SX Reverb
38	SX Delay
39	Cloud Delay
40–127	–

INPUT FX (MIDI ch 5)

Value of CC#83	Effect name
0	(OFF)
1	Auto Pitch
2	Vocoder
3	Harmony
4	Gt Amp Sim
5	Chorus
6	JUNO Chorus
7	Reverb
8	TimeCtrlDly
9	Chromatic PS
10	Downer
11	WrmSaturator
12	303 VinylSim
13	404 VinylSim
14	Cassette Sim
15	Lo-fi
16	Equalizer
17	Compressor
18–127	–

List of Shortcut Keys

You can quickly recall a desired function or screen by pressing a button or pad while holding down the [SHIFT] button.

Shortcuts that use the [SHIFT] button

While holding down the [SHIFT] button	Function	Explanation
Bank [A/F]–[E/J] buttons	BANK VOLUME	Adjusts the volume for the specified bank overall. → “Adjusting the Volume for All Banks (BANK VOLUME)(P.13)”
[COPY] button	BANK PROTECT	This function prevents the samples and patterns assigned to a pad from being copied, overwritten by editing or accidentally deleted. → “Protecting a Sample (PROTECT)(P.57)”
[BPM SYNC] button	SYNC ALL ON/OFF	Turns the BPM SYNC parameter for all samples in the selected bank on/off.
[LOOP] button	PING-PONG LOOP	Loops the sample by repeatedly playing back forward and then backward. → “Playing Back Samples Repeatedly (LOOP)(P.17)”
[GATE] button	GATE ALL ON/OFF	Turns the GATE parameter for all samples in the selected bank on/off.
[ROLL] button	ROLL SET	This shows how to set the roll interval (how fast the roll repeats). → “Setting the Roll Interval(P.19)”
[START/END] button	CHOP	Splits the sample at the marker positions, and assigns the resulting samples to separate pads. → “Using a Marker to Split and Assign a Sample to a Pad (CHOP)(P.48)”
[PITCH/SPEED] button	ENVELOPE	Sets how the volume changes when the sample plays back. → “Making Fade-in/Fade-out Settings (ENVELOPE)(P.49)”
[MARK] button (at least three seconds)	SAVE EFX PARAMETER	Saves the main parameters of the effects assigned to BUS 1 and BUS 2. → “How the effect parameters are saved and shared(P.33)”
[PATTERN SELECT] button	UNDO	Undoes the data you just inputted (recorded). ● Enabled only when recording a pattern
[REMAIN] button (at least three seconds)	LIVE MODE	Use this to disable buttons that are not used when playing live (sampling and edit-related buttons). → “Disabling Buttons that Are Not Used When Playing Live (LIVE MODE)(P.28)”
[EXIT] button	STOP	Stops the playback of all samples. → “Stopping All Sample Playback (STOP)(P.27)”
Pad [1]	FIXED VELOCITY	Sets the sample’s velocity so that it always plays back at 127 (the maximum). → “Setting a Fixed Sample Volume (FIXED VELOCITY)(P.21)” “Changing the Pitch or Playback Speed of a Sample (PITCH/SPEED)(P.52)”
Pad [2]	16 VELOCITY	Changes a sample’s velocity (volume) in steps when it plays back. → “Changing the Sample Volume for Playback (16 VELOCITY)(P.22)”
Pad [3]	CUE	Adjusts the balance of the audio you monitor via the PHONES jack. → “Monitoring with Headphones (CUE)(P.95)”
Pads [4]	CHROMATIC	Lets you play back samples (changing their pitches) as a chromatic scale with the pads. → “Playing Back Samples in Scale Pitches (CHROMATIC)(P.23)”
Pad [5]	EXCHANGE	Exchanges (swaps) the sample or pattern data saved in different pads. → “Exchanging (Swapping) Samples Between Pads(P.56)”
Pad [6]	INIT PARAM	Initializes the sample parameters for the selected pad. → “Initializing the Sample Parameters (INIT PARAM)(P.55)”
Pad [7]	PAD LINK	Lets you play back all the pads at the same time that are assigned to a group, by using a single pad. → “Playing Back Multiple Pads at the Same Time (PAD LINK GROUPS)(P.25)”
Pad [8]	MUTE GROUP	Groups together samples that you don’t want to play together (samples that you don’t want layered). → “Preventing Samples from Playing Back at the Same Time (MUTE GROUP)(P.26)”
Pad [9]	METRONOME	Turns the metronome on/off. → “Sampling(P.39)” , “Resampling a Sample (RESAMPLE)(P.41)” , “Creating a New Pattern (Real-time Recording)(P.60)” , “Sampling a Pattern (RESAMPLE)(P.65)”
Pad [10]	COUNT-IN	Adds a count-in before sampling or pattern recording begins. → “Adding a Count-in Before Sampling(P.39)” “Adding a Count-in Before Recording a Pattern(P.61)”
Pad [11]	TAP TEMPO	Lets you set the tempo in an intuitive way by tapping the pad in time, as if you were clapping out the beat.

		→ “Setting the Tempo in Time with the Rhythm (Tap Tempo)(P.86)”
Pad [12]	GAIN	Displays the UTILITY MENU > SYSTEM > GAIN tab. → “GAIN(P.125) tab”
Pad [13]	UTILITY	Displays the UTILITY MENU screen. → “Configuring the Various Settings (UTILITY)(P.106)”
Pad [14]	IMPORT/EXPORT	Displays the UTILITY MENU > IMPORT (IMPORT/EXPORT MENU). → “Importing Samples (IMPORT SAMPLE)(P.116)” “Exporting Samples (EXPORT SAMPLE)(P.117)” “Importing a Project (IMPORT PROJECT)(P.118)” “Exporting a Project (EXPORT PROJECT)(P.119)”
Pads [15]	PAD SETTING	Displays the UTILITY MENU > PAD SET (PAD SETTING). → “Configuring the Pad-related Settings (PAD SETTING)(P.107)”
Pad [16]	EFX SETTING	Displays the UTILITY MENU > EFX SET (EFX SETTING) screen. → “Configuring the Effect Settings (EFX SET)(P.108)”
[REVERSE] button + Pads [1]–[16]	PAD MUTE	Switches the pad mute on/off. → “Muting the Playback of a Sample (PAD MUTE)(P.24)”
[BUS FX] button	MUTE BUS	Temporarily turns off the audio sent to the bus (the sample playback sound or the sound inputted to the INPUT jack), and outputs only the sound of the effect. → “Temporarily Output Only the Effect Sound (MUTE BUS)(P.35)”
[HOLD] button	PAUSE	Pauses the sample that’s currently playing back. → “Pausing the Sound of a Sample (PAUSE)(P.27)”
[EXT SOURCE] button	INPUT SETTING	Displays the input settings screen. → “Configuring the Sampling Settings (RECORD SETTING)(P.37)”
[SUB PAD] button	PROJECT	Displays the SELECT PROJECT screen. → “Selecting a Project(P.98)”

Shortcuts that use the [REMAIN] button

While holding down the [REMAIN] button	Function (explanation)
Pads [1]–[16]	Sets which sample playback audio is sent to which bus (meaning which effects are used) for each sample. → “Deciding on Effects to Use for Each Sample(P.30)”
CH1: Pad [14] CH2: Pad [16] (only in DJ mode)	You can set the bus to which the CH1/CH2 sample playback is sent (meaning which effects are used). While holding down the [REMAIN] button, each time you press pad [14] or pad [16] switches the effect to use as follows: “BUS-1” -> “BUS-2” -> “DRY” -> “BUS-1”.
Bank [A/F]–[E/J] buttons	Sets the bus send destination for all samples in a bank.
[MFX] button	Makes the effect edit screen keep displaying. → “Editing the Effects(P.33)”
[BUS FX] button	You can swap the effects of BUS 1 and BUS 2.

Shortcuts that use the [VALUE] knob

While holding down the [VALUE] knob	Function (explanation)
Effect buttons ([FILTER+DRIVE]–[MFX] button)	Applies effects only while you hold down the effect buttons (EFFECT GRAB). → “Turning Effects On/Off at the Desired Timing(P.34)”
[GATE] button	Switches the “one-shot playback” sample playback mode on/off. → “Playing Back Samples Only One Time (One-shot Playback)(P.16)”
[BUS FX] button	Temporarily bypasses BUS 3 and BUS 4.
Pads [1]–[16]	Selects a sample (no sound is produced). Also, selects a pattern when [PATTERN SELECT] is lit (the pattern does not play back).

Shortcuts that use the [DEL] button

While holding down the [DEL] button	Function (explanation)
-------------------------------------	------------------------

[EXIT] button	Deletes all samples or patterns in a bank. → "Deleting the Sample from a Pad(P.57)" "Deleting the Pattern from a Pad(P.80)"
---------------	--

Shortcuts that use the [COPY] button

While holding down the [COPY] button	Function (explanation)
[EXIT] button	Copies all samples or patterns in a bank to a different bank. → "Copying the Sample from a Pad(P.56)" "Copying the Pattern of a Pad(P.78)"

Shortcuts that use the [MFX] button

While holding down the [MFX] button	Function (explanation)
[DJFX LOOPER] button	Displays the MFX LIST from #17 onwards. → "Using the MFX Effects(P.31)"
[ISOLATOR] button	Displays the MFX LIST from #33 onwards. → "Using the MFX Effects(P.31)"

Error Messages

Error messages	Explanation	Action
Battery Low!	The batteries are nearly depleted.	Replace the batteries, or switch to an AC adaptor. → “About the Power Supply(P.8)”
Unsupported FILE	The file type is not supported on this unit.	Check the file extension, format and folder directory. → “Importing/Exporting (Using the SD Card)(P.114)”
No SD CARD!	No SD card is inserted. Also, the SD card might not be fully inserted.	Turn off the power, and make sure that the SD card is fully inserted before you turn the power back on.
Unsupported SD Card!	An unsupported type of SD card has been inserted.	Please format the SD card. → “Formatting an SD Card(P.121)”
SD CARD Protected!	The write-protect feature has been enabled on the SD card.	Unlock the lock switch on the left side of the SD card.
SD CARD Full!	The SD card has run out of free space.	Delete any unneeded data on the card.
Internal Storage Full!	There is not enough storage capacity left on this unit.	Delete any unneeded data on the unit.
Storage Error!	A problem has occurred with the internal storage.	Try performing a factory reset. → “Restoring the Factory Settings (FACTORY RESET)(P.122)”
Protected!	The function can't be executed because bank protect is enabled.	Use a bank for which bank protect is disabled, or disable bank protect on the currently selected bank. → “Selecting a Sample Bank(P.12)” “Selecting a Pattern Bank(P.67)” “Protecting a Sample (PROTECT)(P.57)” “Protecting a Pattern (PROTECT)(P.80)”
Max Length Pattern	The maximum number of notes that can be recorded to the pattern sequencer has been exceeded.	Reduce the number of notes in the pattern, or shorten and split the pattern to record. → “Creating a New Pattern (Real-time Recording)(P.60)” “Creating a New Pattern (TR-REC)(P.62)”

Audio Diagram

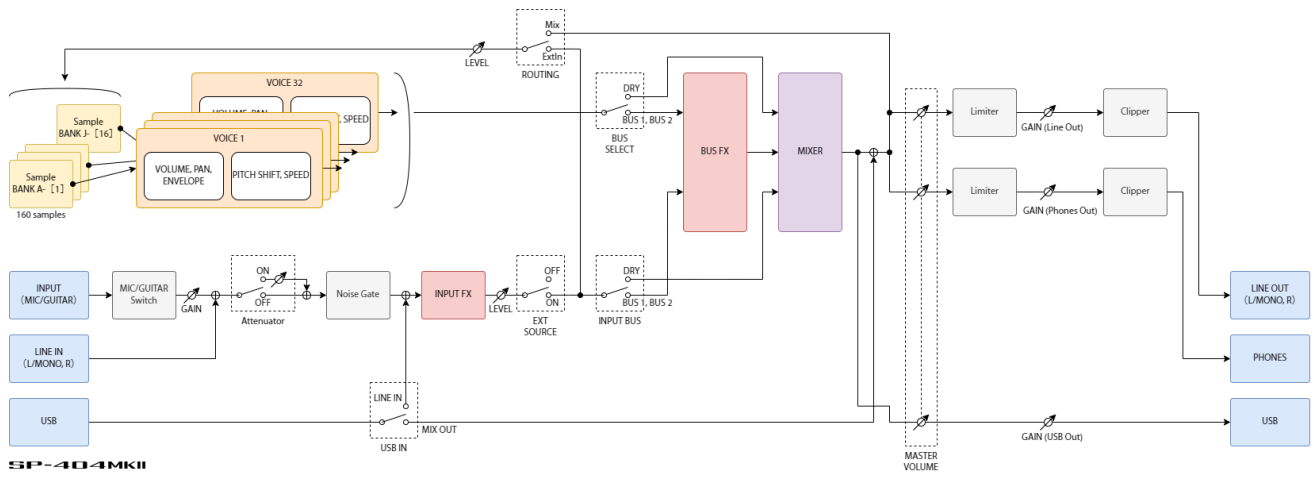

Main Specifications

Maximum polyphony	32 voices
Recordable Data	Samples: 2,560 (16 samples x 10 banks x 16 projects: stored in internal storage) Patterns: 2,560 (16 patterns x 10 banks x 16 projects: stored in internal storage)
Internal storage	Size: 16 GB *Include preload data
Maximum sampling time	16 minutes (approximately 185 MB per sample)
Skip back sampling time	Maximum 25 seconds (Always records LINE OUT signal independently of sampling/resample)
Data format	16-bit linear
Import format	WAV, AIFF, MP3 import supported. *SP-404MK2 App supports WAV, AIFF, MP3, FLAC, M4A.
Sample rate	48 kHz
Pattern sequencer	Resolution: 480 ticks per quarter note Pattern length: 1 to 64 bars Recording method: Realtime Loop Recording (with shuffle quantize function), TR-REC (Automation supported)
Effects	Multi-effects: 41 types Input effects: 17 types
Pads	16 pads + 1 sub pad (Velocity-sensitive pad)
Controllers	Control knob x 3
Display	Graphic OLED display
External storage	SD card (SDHC compatible, commercially available) * For backup, restore, import, and export functions
Connection terminals	PHONES jacks: 1/4-inch phone type, Stereo miniature phone type LINE OUT (L/MONO, R) jacks: 1/4-inch TRS phone type (impedance balanced) LINE IN (L/MONO, R) jacks: 1/4-inch phone type MIC/GUITAR IN jacks: 1/4-inch TRS phone type (for MIC), 1/4-inch phone type (for GUITAR) MIDI (IN, OUT) jack: Stereo miniature phone type USB terminal: USB Type-C® (Audio, MIDI) DC IN jack
Power supply	AC adaptor USB bus power supply (USB Type-C® port, 1.5 A or more) Ni-MH batteries (AA, HR6) (commercially available) x 6 or Alkaline battery (AA, LR6) (commercially available) x 6
Current draw	1,100 mA (AC adaptor) 1,500 mA (USB bus power)
Expected battery life under continuous use	Alkaline battery: Approx. 2.5 hours Ni-MH battery: Approx. 3.5 hours * This can vary depending on the specifications of the batteries, capacity of the batteries, and the conditions of use.
External dimensions	178 (W) x 276 (D) x 71 (H) mm 7 (W) x 10-7/8 (D) x 2-13/16 (H) inches
Weight (excluding AC adaptor)	1.1 kg 2 lbs 7 oz
Accessories	Quick Start "Read Me First" leaflet AC adaptor Warranty card
Options (sold separately)	TRS/MIDI connecting cable: BOSS BMIDI series, BOSS BCC series Wireless MIDI Expression Pedal: BOSS EV-1-WL

* This document explains the specifications of the product at the time that the document was issued. For the latest information, refer to the Roland website.

MIDI Implementation Chart

Model: SP-404MK2

Date: Mar. 9, 2023

Version: 3.00

Function		Transmitted	Recognized	Remarks
Basic Channel	Default	× (MIDI mode A) 1–10 (MIDI mode B)	× (MIDI mode A) 1–10 (MIDI mode B)	*1
	Changed	× (MIDI mode A) 1–10 (MIDI mode B)	× (MIDI mode A) 1–10 (MIDI mode B)	*1
Mode	Default	×	Mode 3	
	Messages	×	×	
	Altered	-	×	
Note Number		35–51 (B1–E ^b 3, MIDI mode A) *1 0, 12–91 (C-1, C0–G6, MIDI mode B) *1 36–60 (C2–C4, CH 16) *7	35–51 (B1–E ^b 3, MIDI mode A) *1 0, 12–91 (C-1, C0–G6, MIDI mode B) *1 0–127 (CH 11) *2 36–60 (C2–C4, CH 16) *6	
	True Voice	-	36–51 (C2–E ^b 3, MIDI mode A) *1 12–91 (C0–G6, MIDI mode B) *1	
Velocity	Note On	○	○	
	Note Off	×	×	
Aftertouch	Key's	×	×	
	Channel's	×	×	
Pitch Bend		×	○ *2	
Control Change	CC#16–19	×	○ *7	Example: 0xB0 10 00 -> BUS 1 Ctrl 1=0 0xB1 13 7F -> BUS 2 EFX switch = ON
	CC#80–83	×	○ *7	Example: 0xB2 50 7F -> BUS 3 Ctrl 4=127 0xB3 53 01 -> BUS 4 EFX number = 01 (303 VinylSim)
	CC#07	○ *8	○ *8	Example: 0xB1 07 7F -> CH2 volume slider = 127
	CC#08	○ *8	○ *8	Example: 0xB0 08 7F -> X-FADE = 0:127 (CH1 = 0, CH2 = 127)
	CC#20–27	○ *8	×	Example: 0xB0 14 01 -> CH1 play 0xB2 1A 7F -> press the pattern sequencer [BPM+] button
Program Change	×	○ *1 *9	Example: 0xC3 0F -> Bank D Pattern 16	
System Exclusive	×	×		
System Common	Song Position	×	×	
	Song Select	×	×	
	Tune Request	×	×	
System Realtime	Clock	○ *3	○ *4	
	Commands	○ *3	○ *4	
Aux Messages	All Sound Off	×	○ *5	
	Reset All Controllers	×	×	
	Local On/Off	×	×	
	All Notes Off	×	×	
	Active Sensing	○	○	
System Reset	×	×		
Notes	*1: Refer to "MIDI Note Map(P.151)". *2: Enabled when INPUT FX is "Vocoder" (MIDI CH 11).			

- *3: Output when MIDI Sync Out is "ON" and when there is no tempo input from an external device.
 *4: Enabled when this unit is in remote mode (when a tempo signal is received from an external device).
 *5: All samples stop playing back when the MIDI cable is unplugged.
 *6: Enabled when playing samples in chromatic mode (MIDI CH 16).
 *7:

MIDI channels	
CH 1:	BUS 1
CH 2:	BUS 2
CH 3:	BUS 3
CH 4:	BUS 4
CH 5:	INPUT

Control change message numbers and corresponding EFX controls	
CC#19	EFX switch (0–63: OFF, 64–127: ON)
CC#83	EFX number (0–127) "Control change messages and corresponding effects(P.140)"
CC#16	Ctrl 1 (0–127)
CC#17	Ctrl 2 (0–127)
CC#18	Ctrl 3 (0–127)
CC#80	Ctrl 4 (0–127)
CC#81	Ctrl 5 (0–127)
CC#82	Ctrl 6 (0–127)

*8:

Control change message numbers and corresponding controllers in DJ mode			
	MIDI channel 1 (CH1 sample)	MIDI channel 2 (CH2 sample)	MIDI channels 3 (pattern sequencer)
CC#7	[Ctrl 1] knob: CH1 volume slider (0–127)	[Ctrl 2] knob: CH2 volume slider (0–127)	[Ctrl 1] knob: pattern sequencer volume slider (0–127)
CC#8	[Ctrl 3] knob: X-FADE (CH1: CH2 = 127:0–0:127)	-	-
CC#20	[▶/] button (0: pause, 127: play)	[▶/] button (0: pause, 127: play)	[▶/] button (0: pause, 127: play)
CC#21	[◀◀] button (0: release the button, 127: press the button)	[◀◀] button (0: release the button, 127: press the button)	[◀◀] button (0: release the button, 127: press the button)
CC#22	[SYNC] button (0: Off, 127: On)	[SYNC] button (0: Off, 127: On)	[SYNC] button (0: Off, 127: On)
CC#23	[CUE] button (0: Off, 127: On)	[CUE] button (0: Off, 127: On)	[CUE] button (0: Off, 127: On)
CC#24	[BEND+] button (0: release the button, 127: press the button)	[BEND+] button (0: release the button, 127: press the button)	[BEND+] button (0: release the button, 127: press the button)
CC#25	[BEND-] button (0: release the button, 127: press the button)	[BEND-] button (0: release the button, 127: press the button)	[BEND-] button (0: release the button, 127: press the button)
CC#26	[BPM+] button (0: release the button, 127: press the button)	[BPM+] button (0: release the button, 127: press the button)	[BPM+] button (0: release the button, 127: press the button)
CC#27	[BPM-] button (0: release the button, 127: press the button)	[BPM-] button (0: release the button, 127: press the button)	[BPM-] button (0: release the button, 127: press the button)

*9:

Program change numbers and corresponding patterns	
PC#0	Pattern 1
PC#1	Pattern 2
:	:
PC#15	Pattern 16

Mode 1: OMNI ON, POLY

Mode 2: OMNI ON, MONO

Mode 3: OMNI OFF, POLY

Mode 4: OMNI OFF, MONO

○: Yes

x: No

MIDI Note Map

MIDI Mode		A				B				
MIDI Channel		CH 1		...	CH 10		CH 1-9		CH 2-10	
Note Number		BANK	PAD	...	BANK	PAD	BANK	PAD	BANK	PAD
127	G9	Blank		...	Blank		Blank		Blank	
:	:						(for Note Offset)		(for Note Offset)	
92	A ^b 6									
91	G6						E	4	J	4
90	F [#] 6							3		3
89	F6							2		2
88	E6							1		1
87	E ^b 6							8		8
86	D6							7		7
85	C [#] 6							6		6
84	C6							5		5
83	B5							12		12
82	B ^b 5							11		11
81	A5							10		10
80	A ^b 5							9		9
79	G5							16		16
78	F [#] 5							15		15
77	F5							14		14
76	E5							13		13
75	E ^b 5						D	4	I	4
74	D5							3		3
73	C [#] 5							2		2
72	C5							1		1
71	B4							8		8
70	B ^b 4							7		7
69	A4							6		6
68	A ^b 4							5		5
67	G4							12		12
66	F [#] 4							11		11
65	F4							10		10
64	E4							9		9
63	E ^b 4							16		16
62	D4							15		15
61	C [#] 4							14		14
60	C4							13		13
59	B3						C	4	H	4
58	B ^b 3							3		3
57	A3							2		2
56	A ^b 3							1		1
55	G3							8		8
54	F [#] 3							7		7
53	F3							6		6
52	E3							5		5
51	E ^b 3	A	4	...	J	4		12		12
50	D3		3			3		11		11
49	C [#] 3		2			2		10		10
48	C3		1			1		9		9
47	B2		8			8		16		16
46	B ^b 2		7			7		15		15
45	A2		6			6		14		14
44	A ^b 2		5			5		13		13
43	G2		12			12	B	4	G	4
42	F [#] 2		11			11		3		3
41	F2		10			10		2		2

MIDI Mode		A		B	
40	E2	9	9	1	1
39	E ^b 2	16	16	8	8
38	D2	15	15	7	7
37	C [#] 2	14	14	6	6
36	C2	13	13	5	5
35	B1	EXT SOURCE		12	12
34	B ^b 1	Blank	... Blank	11	11
33	A1			10	10
32	A ^b 1			9	9
31	G1			16	16
30	F [#] 1			15	15
29	F1			14	14
28	E1			13	13
27	E ^b 1			A 4	F 4
26	D1			3	3
25	C [#] 1			2	2
24	C1			1	1
23	B0			8	8
22	B ^b 0			7	7
21	A0			6	6
20	A ^b 0			5	5
19	G0			12	12
18	F [#] 0			11	11
17	F0			10	10
16	E0			9	9
15	E ^b 0			16	16
14	D0			15	15
13	C [#] 0			14	14
12	C0			13	13
11	B-1			Blank	Blank
:	:			(for Note Offset)	(for Note Offset)
1	C [#] -1				
0	C-1			EXT SOURCE	

SP-404MK2 (Version 3.00)

Reference Manual

01

Roland Corporation

©2021 Roland Corporation