

**PERCUSSION
SOUND MODULE**

TD-7

OWNER'S MANUAL

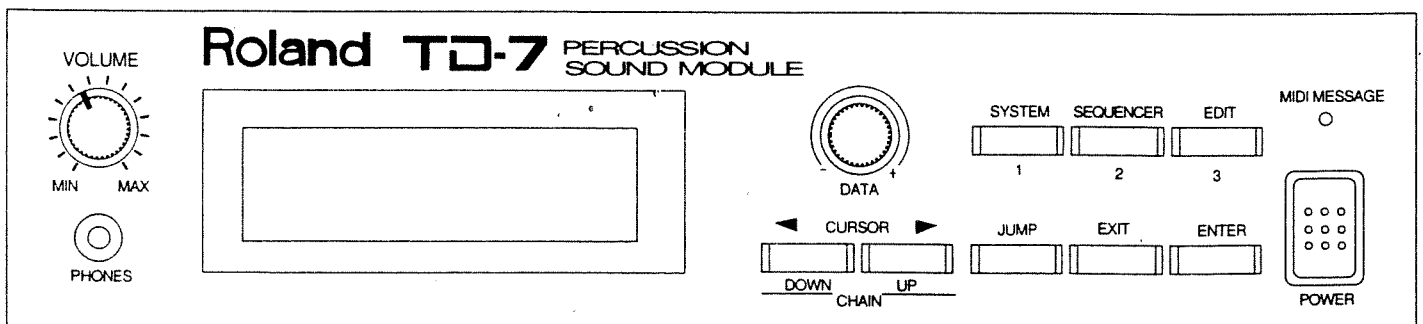

For the U.K.

IMPORTANT: THE WIRES IN THIS MAINS LEAD ARE COLOURED IN ACCORDANCE WITH THE FOLLOWING CODE.

BLUE : NEUTRAL
BROWN : LIVE

As the colours of the wires in the mains lead of this apparatus may not correspond with the coloured markings identifying the terminals in your plug proceed as follows:

The wire which is coloured BLUE must be connected to the terminal which is marked with the letter N or coloured BLACK.

The wire which is coloured BROWN must be connected to the terminal which is marked with the letter L or coloured RED.

Roland TD-7

PERCUSSION SOUND MODULE

OWNER'S MANUAL

INTRODUCTION

Thank you for purchasing the Roland TD-7 Percussion Sound Module. The TD-7 is a superb sound module incorporating Roland's latest technology. To take full advantage of the TD-7's capabilities, and to ensure years of trouble-free service, please read this Owner's Manual carefully.

Copyright © 1992 by ROLAND CORPORATION

All rights reserved. No part of this publication may be reproduced in any form without the permission of Roland Corporation.

Important Notes

Be sure to use only the adaptor supplied with the unit. Use of any other power adaptor could result in damage, malfunction, or electric shock.

Power Supply

- When making any connections with other devices, always turn off the power to all equipment first; this will help prevent damage or malfunction.
- Do not use this unit on the same power circuit with any device that will generate line noise, such as a motor or variable lighting system.
- The power supply required for this unit is shown on its nameplate. Ensure that the line voltage of your installation meets this requirement.
- Avoid damaging the power cord; do not step on it, place heavy objects on it etc.
- When disconnecting the AC adaptor from the outlet, grasp the plug itself; never pull on the cord.
- If the unit is to remain unused for a long period of time, unplug the power cord.

Placement

- Do not subject the unit to temperature extremes (e.g. direct sunlight in an enclosed vehicle). Avoid using or storing the unit in dusty or humid areas or areas that are subject to high vibration levels.
- Using the unit near power amplifiers (or other equipment containing large transformers) may induce hum.
- This unit may interfere with radio and television reception. Do not use this unit in the vicinity of such receivers.

Maintenance

- For everyday cleaning wipe the unit with a soft, dry cloth (or one that has been slightly dampened with water). To remove stubborn dirt, use a mild neutral detergent. Afterwards, be sure to wipe the unit thoroughly with a soft, dry cloth.
- Never use benzine, thinners, alcohol or solvents of any kind, to avoid the risk of discoloration and/or deformation.

Additional Precautions

- Protect the unit from strong impact.
- Do not allow objects or liquids of any kind to penetrate the unit. In the event of such an occurrence, discontinue use immediately. Contact qualified service personnel as soon as possible.
- Never strike or apply strong pressure to the display.
- A small amount of heat will radiate from the unit, and thus should be considered normal.
- Should a malfunction occur (or if you suspect there is a problem) discontinue use immediately. Contact qualified service personnel as soon as possible.
- To prevent the risk of electric shock, do not open the unit or its AC adaptor.

Memory Backup

- The unit contains a battery which maintains the contents of memory while the main power is off. The expected life of this battery is 5 years or more. However, to avoid the unexpected loss of memory data, it is strongly recommended that you change the battery every 5 years.
Please be aware that the actual life of the battery will depend on the physical environment (especially temperature) in which the unit is used. When it is time to change the battery, consult with qualified service personnel.
- When the battery becomes weak, the following message will appear in the display:

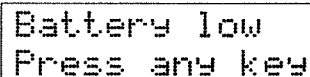

```
Battery low
Press any key
```

Please change battery as soon as possible to avoid the loss of memory data.

- Please be aware that the contents of memory may at times be lost; when the unit is sent for repairs or when by some chance a malfunction has occurred. Important data should be stored in another MIDI device (e.g. a sequencer), or settings written down on paper. During repairs, due care is taken to avoid the loss of data. However, in certain cases (such as when circuitry related to memory itself is out of order), we regret that it may be impossible to restore the data.

Conventions in this manual

[Name of a button] : Represents a key or knob on the front panel of the unit.

☞ : This symbol is followed by a page number where relevant information can be found.

* : This symbol is followed by a cautionary note or important information.

↪ : This symbol is followed by what you should refer to.

TABLE OF CONTENTS

- Important Notes
- Conventions in this manual
- Table of Contents
- Panel Descriptions
- Features
- Installing the TD-7 on a Stand

Chapter 1 Playing the TD-7

- 1. Connections and Precautions 12
- 2. Power ON / Power OFF 17
- 3. Adjusting the LCD Contrast 18
- 4. Playing the Demo Songs 19
- 5. Quick Start (Experimenting
with various performances) 20
 - [1] Patch Selection 20
 - [2] Rim Shot 20
 - [3] Choke Effect 22
 - [4] Playing Sequence Patterns 23
 - [5] Patch Editing 24
 - [6] The Patch Chain 25

Chapter 2 Basic Operation / Inside the TD-7

- 1. Basic Operation 30
 - [1] Setting Parameters 30
 - [2] The Jump Function 31
 - [3] Main Screen 34
- 2. Inside the TD-7 36
 - [1] Parameters in a Patch 37
 - [2] Other Parameters 38

Chapter 3 Patch Setting

- 1. Setting a Patch 40
 - [1] Naming a Patch 40
 - [2] Assigning a Note Number to a Trigger Signal 41
 - [3] Setting Various Trigger Parameters 43
 - [4] Instrument Section 49
 - a. Setting Sound 1 and 2 49
 - b. Layer 52
 - [5] Performance Section 56
 - [6] Effects 59
 - a. Parameters for Effect 1 62
 - b. Parameters for Effect 2 64
 - [7] Hi-hat Control Pedal 65
 - [8] Program Change Numbers 70
- 2. Patch Copy 71
- 3. Global Performance Parameters 73

Chapter 4 Editing Instrument Sounds

1. Instrument Parameters 78
2. Instrument Copy 89

Chapter 5 Phrase Sequencer

1. How to Record Sequence Data 92
2. Phrase Sequencer 95
 - [1] Recording and playback of Sequence Patterns 96
 - [2] Setting Beat and Measure Number and erasing Sequence Data 98
 - [3] Selecting a Performance Type 100
 - [4] Copying Sequence Pattern 101
3. Tempo, Metronome, Available Memory and Synchronized Playback 104
 - [1] Tempo Setting 104
 - [2] Setting the Metronome 104
 - [3] Available Memory 105
 - [4] Synchronized Playback 105

Chapter 6 System Setting

1. MIDI 108
 - [1] MIDI Messages 108
 - [2] The TD-7's MIDI Messages 111
 - [3] Setting MIDI Parameters 114
2. Setting the Interface Mode 123
3. Using the Footswitch and Sound-on-Sound 124
 - [1] How to set the Footswitch Mode 124
 - [2] Using the Sound-on-Sound Function 126
4. The Sound Setup 129
5. Initialization 132
 - [1] Hi-hat Control Pedal Initialize 132
 - [2] All Initialize 133

Chapter 7 Reference

1. Error Messages 136
 2. Troubleshooting 138
 3. Patch List 141
 4. Waveform List 144
 5. Instrument List 146
 6. Initial Settings 150
 7. Blank Chart 153
-
- Roland Exclusive Messages 156
 - MIDI Implementation 158
 - MIDI Implementation Chart 164
 - How to read the MIDI Implementation chart 166
 - Specifications 167
 - Index 168
 - Information 170

PANEL DESCRIPTIONS

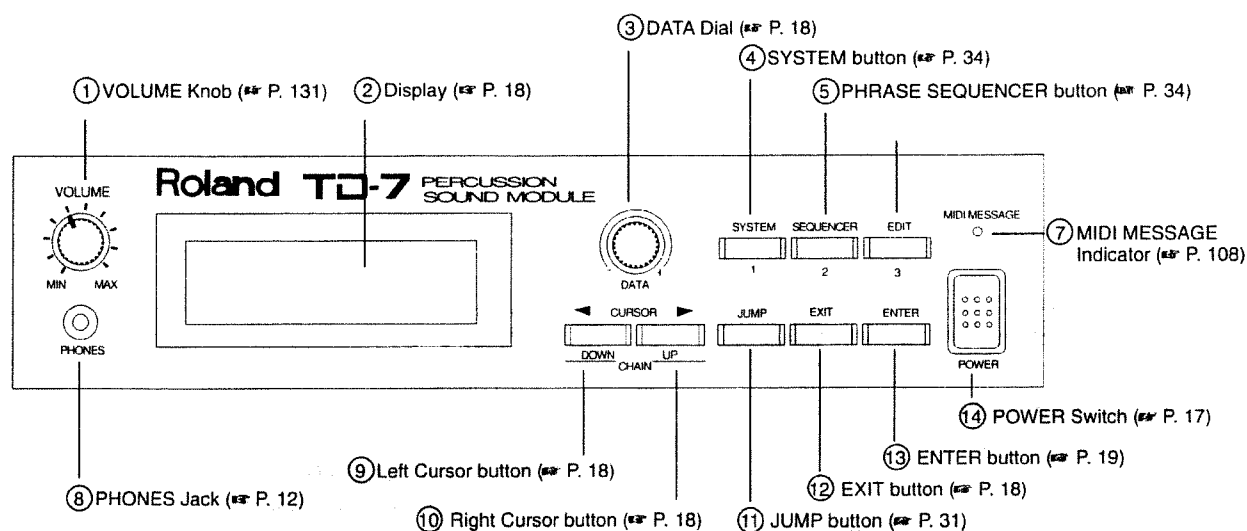

① [VOLUME] Knob

This knob controls the volume of the sound output through the OUTPUT jacks and PHONES jack.

② Display (LCD)

The display indicates the current operating condition or value of a particular parameter.

③ [DATA] Dial

Use this dial to select parameters and/or set parameter values.

④ [SYSTEM] button

Use this button to set parameter values which apply to the entire system, such as those for MIDI (P. 108), footswitch (P. 24) or Sound Setup (P. 129).

⑤ [SEQUENCER] button

Use this button to set or edit the Sequence patterns of a Phrase Sequencer (P. 92) for Sync performance, etc.

⑥ [EDIT] button

Use this button to set Instrument parameters or parameter values in a Patch (P. 40).

* The [SYSTEM], [SEQUENCER] or [EDIT] button may be assigned a different function depending on the Parameter Setting Display.

⑦ MIDI MESSAGE Indicator

This indicator lights when MIDI messages are being received.

⑧ PHONES Jack

Connect headphones (e.g. Roland RH-120 : optional) to this jack. The appropriate impedance of headphones is 8 to 150 ohms. Even when headphones are connected, sound is output through the OUTPUT jacks.

⑨ Left Cursor button

This button moves the cursor (flashing point) in the LCD to the left. In the Patch Play screen, the same button will serve to call the sequence of Patches in a Patch Chain.

⑩ Right Cursor button

This button moves the cursor (flashing point) in the LCD to the right. In the Patch Play screen, the same button will serve to call the sequence of Patches in a Patch Chain.

⑪ [JUMP] button

Use this button to jump (move) to a specified screen.

⑫ [EXIT] button

Use this button to leave (exit) the current screen.

⑬ [ENTER] button

Use this button to execute (proceed with) the operation/function you have set.

⑭ [POWER] Switch

This switch turns the unit ON and OFF.

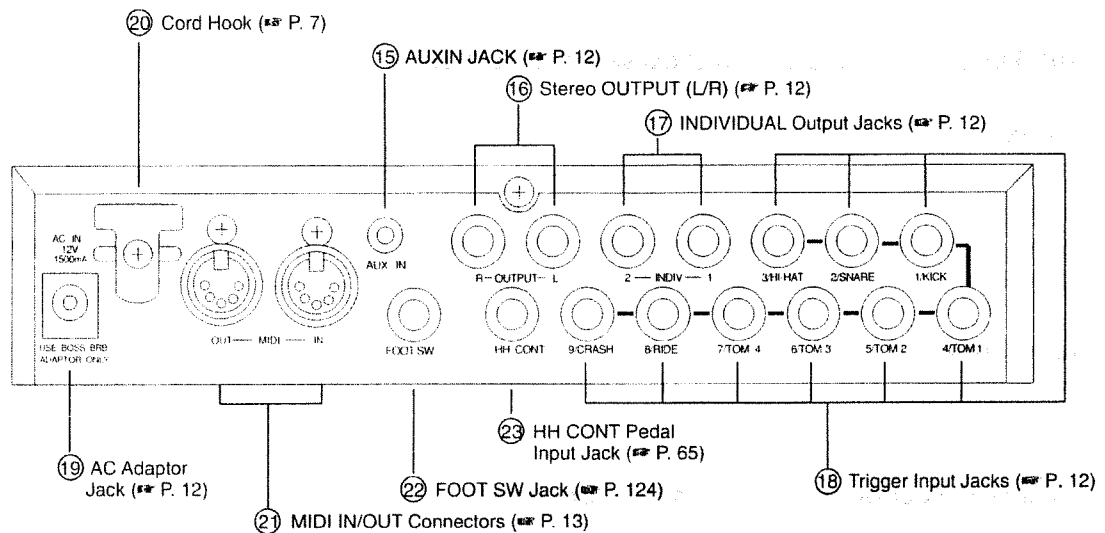

15) AUX IN Jack

Audio signals from an external unit (such as a CD player or cassette deck) can be fed into this jack, mixed with the TD-7's Sounds and output to the PHONES jack (only). This allows you to play along with recorded music using the sounds of the TD-7.

16) OUTPUT (L/R) Jacks (STEREO Outputs)

These jacks provide a stereo output. For monaural output, use either jack (L or R).

17) IND 1/2 Output Jacks (INDIVIDUAL Outputs)

Each jack provides output of one user-specified Instrument sound. (# P. 129)

18) 1/KICK 2/SNARE 3/HH-HAT 4/TOM 1 5/TOM 2 6/TOM 3 7/TOM 4 8/RIDE 9/CRASH (Trigger Input Jacks)

These input jacks receive trigger signals from the corresponding drum pads (up to 9 pads). The Instruments have been pre-assigned at the factory, but you can change the assignments as required. These are stereo jacks and can receive Rim Shot and Choke Effect signals when you are using optional PD-7 pads. You can also connect other types of pads (e.g. PD-21 : optional) to any of these jacks using a mono cable.

19) AC Adaptor Jack

Connect the supplied AC adaptor to this jack.

20) Cord Hook

Loop the AC adaptor cord around this hook to prevent the adaptor from accidental disconnection.

21) MIDI IN/OUT Connectors

These sockets are for connecting MIDI devices. (# P. 12)

22) FOOT SW (Footswitch) Jack

Connect a footswitch (FS-5U : optional) to this jack. You can assign the desired function to the footswitch, such as Patch selector, hold switch or recording start switch for Sound-on-Sound (# P. 126). This is a stereo jack and therefore should be divided into two monaural inputs with a special cable (PCS-31 : optional) when using two footswitches.

23) HH CONT (Hi-hat Control) Pedal Input Jack

This jack receives control signals from the Hi-hat Control Pedal (FD-7 : optional). This is a stereo jack.

How to use the Cord Hook

Connect the included AC adaptor to the TD-7, and then plug it into an AC outlet. By looping the AC adaptor cable around the Cord Hook, you can prevent the plug from accidentally being disconnected.

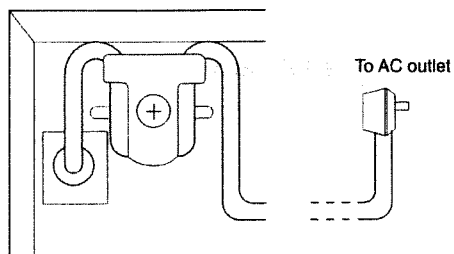

Note: Please use only the included AC adaptor. Using other AC adaptors can result in malfunctions or electric shock.

FEATURES

1. The TD-7 contains 512 percussion sounds!

■ Sounds

Up to 512 Instrument sounds can be created using 256 basic percussion waveforms. Parameters involved with sound creation are Pitch, Decay, Panning, Nuance, Brilliance, Attack Damp, Velocity, Pitch Bend, Volume and Assign Type.

The 256 waveforms include 43 kick drums, 59 snare drums, 36 toms, 8 hi-hats, 8 cymbals, plus 52 additional percussion Instruments. Also included are 11 mallet Instruments (such as vibraphone), 34 effect sounds and 5 bass sounds.

■ Sound Source

The TD-7 uses a 16-bit sound source which accurately reproduces the dynamic range and harmonic content of all the on-board sounds — depend on how hard you play the pads (velocity).

■ Instrument Section and Performance Sections

The TD-7 contains one Instrument section and three Performance sections and therefore can be used as a 4 Part multi-timbral sound module.

■ Maximum Polyphony

The TD-7 can play up to 14 voices at the same time. A maximum of two voices can be mixed (LAYER), at which time you can use the Velocity Switch, Velocity Mix or Velocity Cross Fade functions.

■ Dynamic Pitch Bend

The amount of pitch bend change depends on how hard you play the pads (velocity).

2. High-speed pad response is made possible by direct trigger inputs!

■ Trigger Input Jacks

The TD-7 is equipped with 9 Trigger Inputs. Using the specified pads (PD-7 : optional), 18 sounds can be controlled (since the Rim Shot signal is recognized as well as the standard center-of-pad signal).

In the sound module section, two voices can be mixed (LAYER), allowing you to control up to 4 voices with one pad (PD-7 : optional).

You can set MIDI Note Number, Gate Time, Velocity Curve, etc. for each trigger signal, and output it as a MIDI Note message.

■ Automatic Trigger Signal Setting Function

This function automatically sets the parameters for the trigger signal of each pad connected to the TD-7. Parameters set with this function are, Minimum Dynamic Range, Maximum Dynamic Range, Minimum Velocity, Mask Time and Threshold Level.

■ Choke Effect

Using the specified pads (PD-7s : optional), you can create Choke effects (muting). This may be useful for Instruments like crash cymbals.

■ Hi-hat Control Pedal Jack

By connecting the specific pedal (FD-7 : optional) to this jack, you can control the sound module section; continuously control the open and closed Hi-hat, play open and closed sounds and also control the pitch, decay or nuance of a specified sound.

3. Using the Phrase Sequencer and Sound-On-Sound, you can enjoy spontaneous performances!

■ Phrase Sequencer

The TD-7 is equipped with a Phrase Sequencer that allows you to record and playback up to 16 measures of data. It can playback 24 Preset Patterns and 24 User Patterns (48 patterns in total).

■ Performance

You can start or stop the Phrase Sequencer using a pad. You can also play a Phrase (recorded on the sequencer) at the tempo you set by tapping on a pad (Tap Performance).

■ Synchronization

The Phrase Sequencer of the TD-7 can synchronize with an external MIDI device (via MIDI).

■ Voice Click

You can use the sound of a Human Voice for the 'tempo click' (metronome) when recording into the sequencer.

■ Sound-On-Sound

You can record data into the sequencer and then play it back immediately. The Sound-on-Sound can record up to 16 measures of data.

4. The On-board mixer and digital effects allow you to control the output at will!

■ Effects

The TD-7 features two sets of effects: Reverb/Delay and Chorus/Flanger. You can use two effects at the same time.

■ AUX IN

This jack receives the audio signal from an external playback device and mixes it with the TD-7's output. The result is output through the PHONES jack.

■ Audio Outputs

The audio outputs consist of a stereo pair (OUTPUT L/R) and two individual outputs (IND 1 and IND 2).

5. Other Useful Functions

- With 32 Patches and 8 Patch Chains (of 16 steps) available, the TD-7 allows you to change Patches during a performance.
- Patch settings can be recorded into the sequencer using the Bulk Dump function.
- The screen is a 2 line, back-lit LCD (16 characters per line). The Patch Numbers are displayed in large, easily read characters.
- You can connect two footswitches to the TD-7 and use them for Patch selection, sustain (hold) or Sound-On-Sound control.
- The JUMP function allows you to move to any specified screen from any other screen.
- The TD-7 is a half-rack (1U) unit easily installed in a system rack or on a drum stand (using the rack mount adaptor or stand holder).

Installing the TD-7 on a Stand

Use the supplied screws (5 x 8mm) to attach the MDS-7 (Drum Stand) to the TD-7 as shown below:

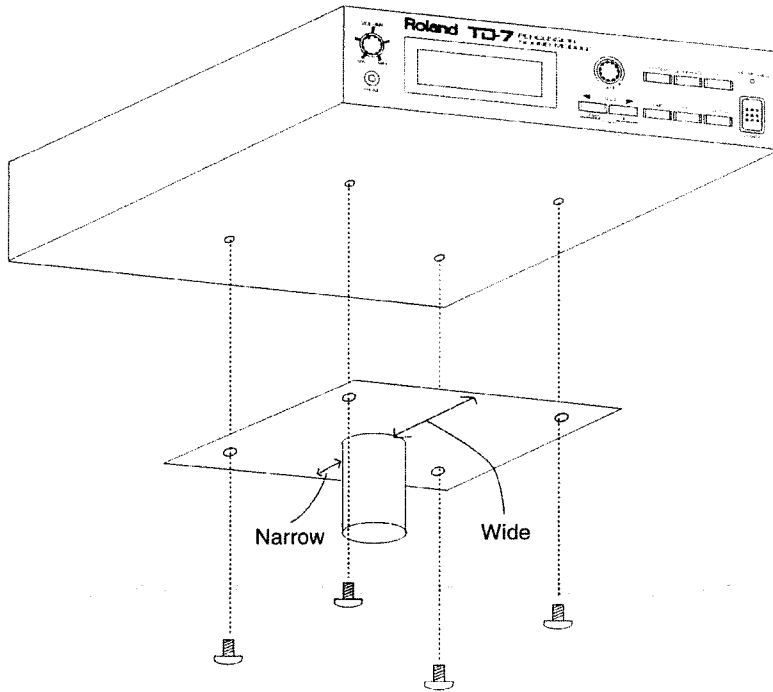

* Using longer screws may damage the TD-7!

If you are not using the optional Rack Mount Adaptor (RAD-50), attach the rubber feet supplied with the TD-7 as shown below:

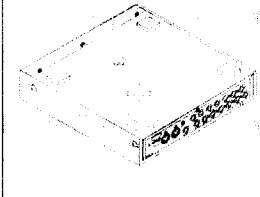

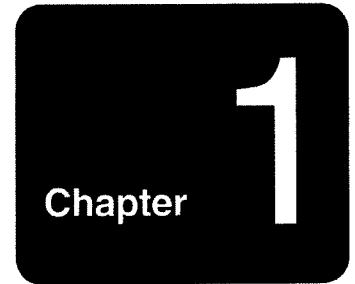

Playing the TD-7

1.Connection and precautions	12
2.Power ON/Power OFF	17
3.Adjusting the LCD Contrast	18
4.Playing the Demo Songs	19
5.Quick Start (Experimenting with various performances)	20

1. CONNECTIONS AND PRECAUTIONS

Before setting up the units, be sure the TD-7 and all external devices are switched off. If you make connections with any unit on, the speakers or other components may be damaged.

■ To play the internal sound module of the TD-7 using pads such as PD-7s:

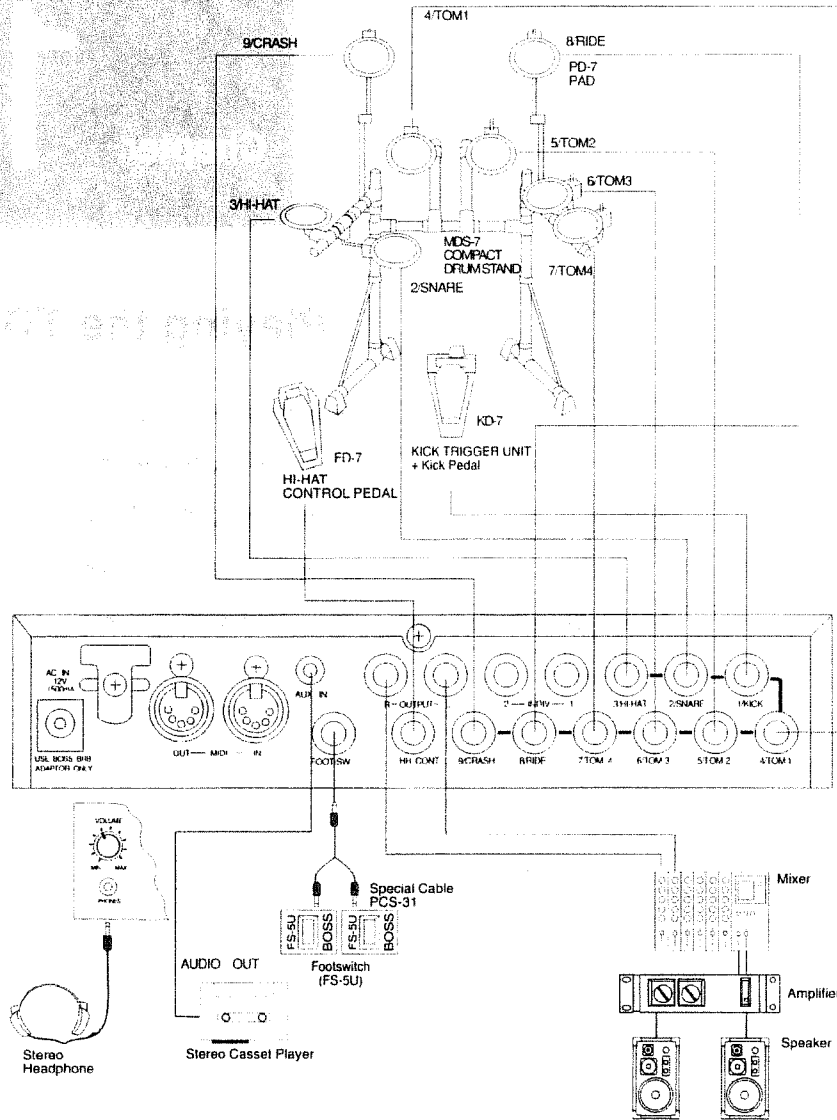

For a quicker setup:

Set MIDI in the System screen to "Midi In = OFF". [P. 117](#)

Set MIDI in the System screen to "Midi Out = OFF". [P. 117](#)

To get the most from the TD-7, use a stereo output whenever possible.

* When using an FD-7, execute Hi-hat Control Pedal Initialization.

[P. 132](#)

* The default settings are as follows:
Midi In = ON
Midi Out = ON

■ Using the TD-7 as a “Trigger to MIDI” converter (playing an external sound source):

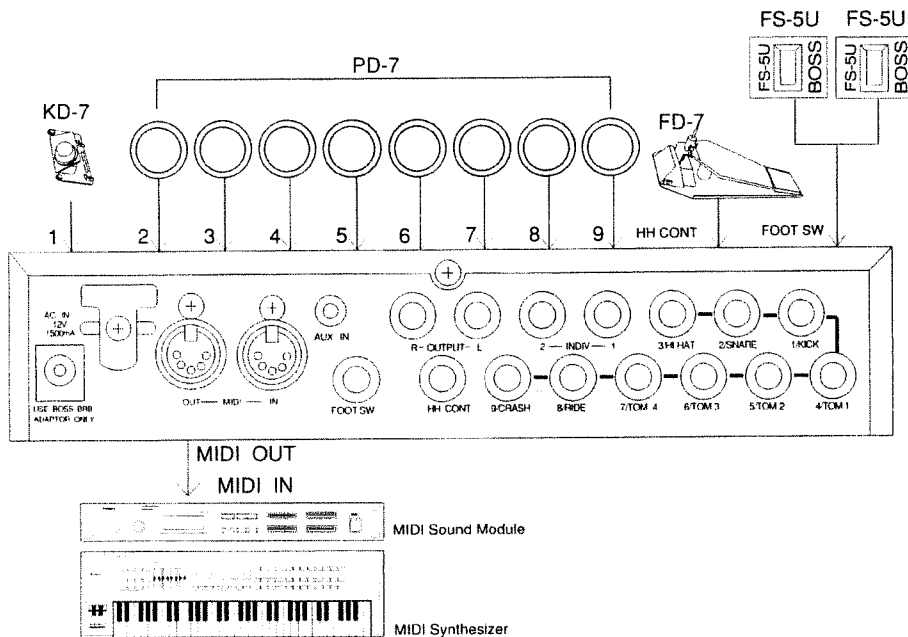

The following setting will accelerate the conversion procedure from 'trigger signal' to 'MIDI signal'. The internal sound module of the TD-7 will not sound.

Set MIDI in the System screen to "Midi In = OFF". [P. 117](#)

Set INTERFACE in the System screen to "MODE=TRIG-MIDI". [P. 123](#)

To get the most from the TD-7, use a stereo output whenever possible.

* The default settings are as follows:
Midi In = ON
INTERFACE
MODE = STANDARD

■ When using a sequencer (such as the Roland MC-50):

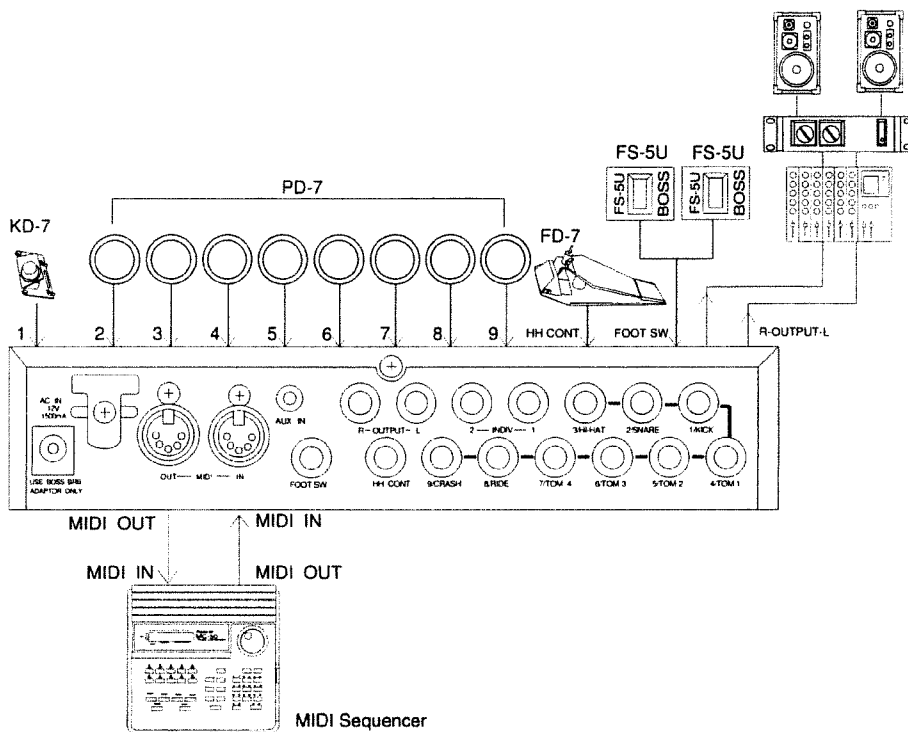

Set MIDI in the System screen to "Midi In = ON". [P. 117](#)

Set MIDI in the System screen to "Midi Out = ON". [P. 117](#)

Set MIDI in the System screen to "Local Ctrl = OFF". [P. 120](#)

Turn the sequencer's Soft Thru function ON.

To get the most from the TD-7, use a stereo output whenever possible.

* The default settings are as follows:

Midi In = ON

Midi Out = ON

Local Ctrl = ON

* Be sure to set the sound setting of the performance data on the sequencer to match the sound setting on the TD-7.

[P. 49, 146](#)

† The TD-7 contains Drum Sets that conform to the GM System (General MIDI System Level 1) and the GS Format.

[P. 141](#)

■ When using a device with MIDI output (such as the Roland PAD-80):

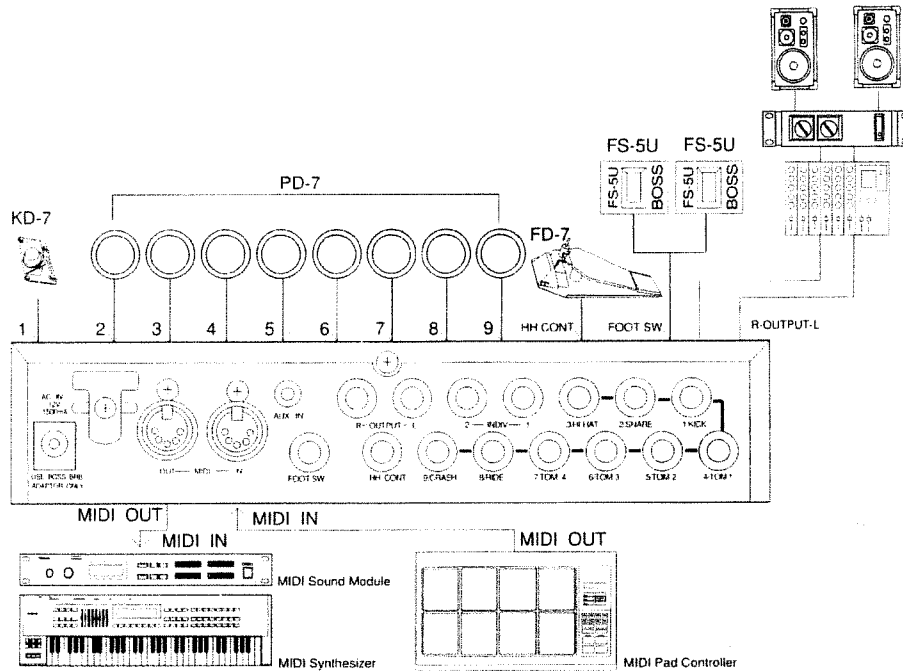

Set Midi in the System screen to "Midi In = ON". P. 117

Set Midi in the System screen to "Midi Out = ON". P. 117

Set Midi in the System screen to "Midi Mix = ON". P. 117

In this way, the MIDI signals sent from the external device, and those of the TD-7, are mixed and output through MIDI OUT.

To get the most from the TD-7, use a stereo output whenever possible.

■ Note on playing the TD-7 from an external MIDI keyboard

MIDI receive channels in the TD-7 are preprogrammed (at the factory) as shown below.

- Instrument Section : Channel 10
- Performance Section 1 : Channel 11
- Performance Section 2 : Channel 12
- Performance Section 3 : Channel 13

To play the TD-7 using a MIDI keyboard, set the transmit channel of the keyboard to 10.

If the transmit channel of the keyboard is not set to any of the above channels, no sound will be heard.

P. 109

* The default settings are as follows:

- Midi In = ON
- Midi Out = ON
- Midi Mix = OFF

* When the TD-7 is set to the defaults, no sound is output from IND 1 or IND 2 (the INDIVIDUAL outputs).

■ About the Pad Setup

When possible, connect the specified pads (PD-7s : optional) to the Trigger Input jacks on the TD-7.

The 9 Trigger Input jacks are all stereo so that two signals (the Rim Shot signal and center-of-pad signal) can be processed at the same time.

Using other drum pads (connected via mono cables) will not cause any problems. No Rim Shot sounds will be produced, however.

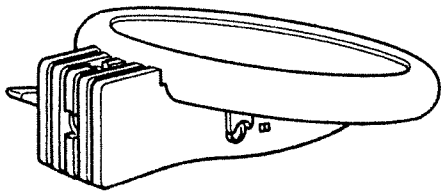

PD-7

2. Power ON / Power OFF

Be sure all devices are switched off before making any connections. When you have made all the necessary connections, switch on the devices in the following order:

- ① Turn on the TD-7.

The display will respond as follows. This is the Patch Play screen for Patch 1.

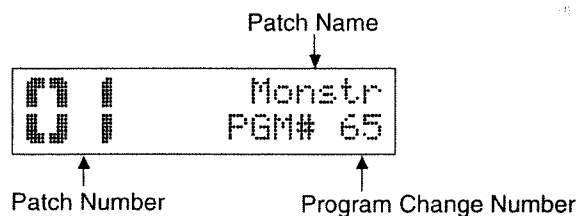

- ② Switch on the external devices connected to the TD-7.
- ③ To power down, first switch off the external devices and then the TD-7.

- The TD-7 contains a circuit protection feature which mutes the output for a few seconds after power up.
- When power is turned on, you should never attempt to hit the pads until after the Patch Play screen has appeared.

* The Patch Play screen will differ depending on the selected Patch.

* When using an FD-7, execute Hi-hat Control Pedal Initialization.

★ P. 132

3. Adjusting the LCD Contrast

The contrast (brightness) of the LCD can be changed. (Variable range : 1 to 15).

- ① Press [SYSTEM] from the Patch Play screen.

```
(SYS)MIDI I I F I I N I  
F s w I D E M O I L C D I S E T
```

- ② Move the cursor to LCD using [◀] and [▶].

- ③ Press [ENTER].

```
LCD  
Contrast = 15
```

- ④ To adjust the contrast of the LCD, change the value with the [DATA] dial.

- ⑤ Press [EXIT] twice to return to the Patch Play screen.

```
01 Monstr  
01 PGM# 65
```

◁ "LCD" stands for Liquid Crystal Display.

◁ The characters at the cursor position will flash.

4. Playing the Demo Songs

You can play any of the demonstration songs stored in the TD-7:

- ① Press [SYSTEM] from the Patch Play screen.

```

(SYS)MIDIIFIINI
FswIDEMOILCDISET
    
```

- ② Move the cursor to DEMO using [◀] and [▶].

- ③ Press [ENTER].

```

DEMO MultiFiesta
START ? -> ENTER
    
```

- ④ Select a Demo Song using the [DATA] dial.

- ⑤ Press [ENTER] to start playback.

```

DEMO MultiFiesta
STOP ? -> EXIT
    
```

- ⑥ Press [EXIT] to stop playback.

- ⑦ Press [EXIT] twice to return to the Patch Play screen.

↔ The characters at the cursor position will flash.

Song Title	Biographies of Composers
Freestyle Music by Steven G. Fisher Copyright © 1992. Roland US	Steven G. Fisher is currently the Percussion Product Manager for Roland Corporation US as well as an accomplished drummer and percussionist. Some credits include many TV commercials, film scores, as well as albums and recordings with artists such as Maynard Ferguson, Dizzy Gillespie, T - Lavitz and the Temptations. His contributions to Roland Corporation include the factory preset patches for the R-8M Total Percussion Sound Module, "90's Dance" Rhythm Style Card for the CR-80, the factory demo songs for the R-70 Human Rhythm Composer and the Dr-660 Dr Rhythm drum machines and numerous clinics and demonstrations.
MultiFiesta Music by Ikuo Kakehashi Copyright © 1992. Roland	Ikuo Kakehashi majored in Percussion at Tokyo College of Music and studied under Prof. Tadahiro Wakabayashi. He has also done extensive research on world music (especially Asian and Arabic). He is involved as a non-border percussionist (Ethnic Music - contemporary music - electronics, pop music) in session and studio work. He also produces Computer Music Software and advises Roland on new musical instruments.
Pages Music by Atsushi Hoshika Copyright © 1992. Roland	Atsushi Hoshika is a member of one of Roland's engineering teams. He performed an important role in the development of the R-70, as well as the R-8 and the DR-550. He has also directed his talents toward the creation of demonstration songs for the R-5 and the R-8.

Warning : All rights reserved. Unauthorized use of this material is a violation of applicable laws.

5. Quick Start (Experimenting with various performances)

The TD-7 contains 32 preprogrammed Patches (1-32) which can be used right away.

First, connect the specified pads (PD-7s) and the Hi-hat Control Pedal (FD-7) to the TD-7. ☞ P. 12

When all the connections are correct and secure, turn on the TD-7. ☞ P. 17

[1] Patch Selection

To change Patches (from the Patch Play screen):

Switching on the TD-7 will automatically select the Patch Play screen:

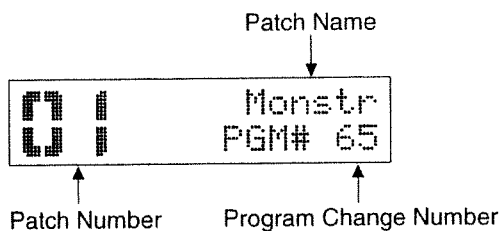

Change any of the 32 Patches (numbered 1-32) using [◀] and [▶].

You can also select Patches by rotating the [DATA] dial.

If you have set a footswitch properly, you can change Patches using the footswitch. ☞ P. 124

[2] Rim Shot

All 32 Patches are set so that Rim Shots can be played from each pad.

A **Rim Shot** is a performance technique in which both the actual pad and the rim of the pad are struck simultaneously. If you only hit the rim of the pad, the proper effect will not be obtained.

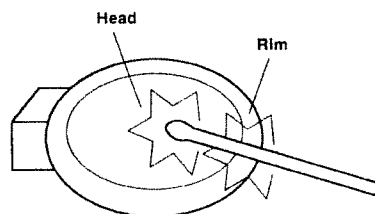

Select Patch 17 (August kit) as an example.

☞: A "Patch" is a collection of sound settings (stored at a numbered memory location).

☞: Depending on the patch selected, what appears in the Patch Play screen will be different.

* For the default value of each Patch, refer to ☞ P. 150.

* Note on playing the TD-7 from an external MIDI keyboard:

MIDI receive channels in the TD-7 are preprogrammed (at the factory) as shown below .

Instrument Section :

Channel 10

Performance Section 1:

Channel 11

Performance Section 2:

Channel 12

Performance Section 3:

Channel 13

To play the TD-7 using a MIDI keyboard, set the transmit channel of the keyboard to 10. If the transmit channel of the keyboard is not set to any of the above channels, no sound will be heard.

● Snare Drum

Be sure a PD-7 is connected to the **2/SNARE** jack on the rear of the TD-7.

Now, hit the head of the pad. You should hear the "126:Frozn.S" sound.

Next, hit the head and rim sections of the pad simultaneously to create the Rim Shot effect. By doing this you should hear the "122:Explo.S" sound.

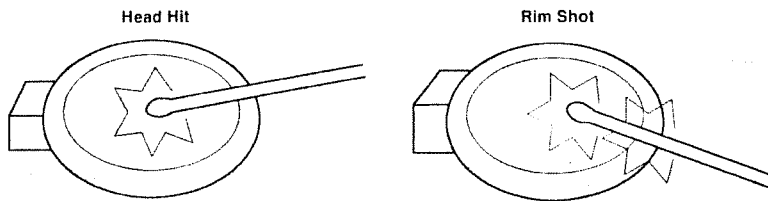

● Tomtom

Be sure the PD-7s are connected to the **4/TOM1**, **5/TOM2**, **6/TOM3** and **7/TOM4** jacks on the rear of the TD-7. Playing the head of each pad will trigger the corresponding "260:Quak1.T" sound, while playing Rim Shots will trigger the "444:Crsh2.E" sounds.

● Ride Cymbal

Be sure a PD-7 is connected to the **8/RIDE** jack on the rear of the TD-7. Playing the head of the pad will trigger the "332:Ride.C" sound, while playing a Rim Shot will trigger the "333:RidBl.C" sound.

● Crash Cymbal

Be sure a PD-7 is connected to the **9/CRASH** jack on the rear of the TD-7. Playing the head of the pad will trigger the "326:Crsh3.C" sound, while playing a Rim Shot will trigger the "331:Chin2.C" sound.

All the Patches in the TD-7 are setup to respond to Rim Shots.

* In order to play two different sounds from one pad, assign one Note Number to the head of the pad (the head trigger signal) (see P. 41) and one to the rim (Rim Shot trigger signal.) Then select an Instrument for each Note Number (see P. 49).

* A Rim Shot is a performance technique in which both the actual pad and the rim of the pad are struck simultaneously. If you only hit the rim of the pad, the proper effect will not be obtained.

[3] Choke Effect

All the TD-7's Patches are set so that the Choke effect can be obtained.

Select Patch 18 (Chicken kit) as an example.  P. 20

● Crash Cymbal

Be sure a PD-7 is connected to the **9/CRASH** jack on the rear of the TD-7.

As usual, playing the head of the pad will trigger the "325:Crsh2.C" sound. However, if immediately after striking the pad you grab hold of the rim, the sound currently being played will be muted or choked. This is the **Choke effect**. The Choke effect is possible even after playing Rim Shots.

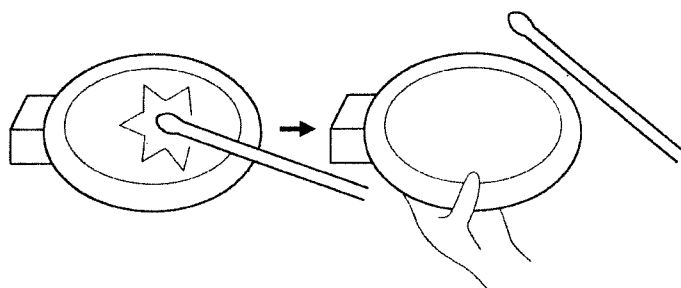

● Ride Cymbal

Be sure a PD-7 is connected to the **8/RIDE** jack on the rear of the TD-7.

Striking the head of the pad will trigger the "332:Ride.C" sound. Again, if you grab the rim of the pad after you have played it, the Choke effect is obtained. The Choke effect can also be obtained after playing a Rim Shot.

The Choke effect can be obtained in all the TD-7's Patches.

* If the Choke effect cannot be properly obtained, refer to Page 45 and check the set value.

⇨ If you hit the pad while grabbing hold of the rim, Decay will be shortened. It can be simulated the Mute Triangle effect.

[4] Playing Sequence Patterns

When you select Patches 19-22, a **Sequence Pattern** will be played by hitting the relevant pad. There are three different Sequence Patterns: Loop, Once and Tap.

● Loop

Hitting a pad once will trigger the Sequence Pattern to play repeatedly until you hit the same pad again.

Select Patch 19 (Blues kit) as an example.  P. 20

Be sure a PD-7 is connected to the **9/CRASH**, **4/TOM1** and **5/TOM2** jack on the rear of the TD-7. Trigger the **CRASH** sound with a Rim Shot. By doing this, the Sequence Pattern will be played simultaneously with the sound. To stop the Sequence Pattern, play another Rim Shot.

Select Patch 20 (Remix kit), then trigger the **TOM1** and **TOM2** sound with a Rim Shot. By doing this, another Sequence Pattern will be played.

● Once

Hitting a pad will cause the corresponding Sequence Pattern to play through once. To play the Pattern again, simply hit the pad again.

Select Patch 21 (Stroke kit) as an example.  P. 20

Hit the head of the PD-7 connected to the **4/TOM 1**, **5/TOM 2**, **6/TOM 3** and **7/TOM 4** jack to play the sound. In this way, a Sequence Pattern will also be played (along with the sound).

Select Patch 22 (Junction kit), then trigger the **TOM1** sound with a Rim Shot. By doing this, another Sequence Pattern will be played.

● Tap

The TAP function allows you to trigger the notes in a sequence one at a time. That is, when you strike a pad, the first note of the Sequence Pattern assigned to that pad will be played. If you strike the same pad again, the second note in that Sequence Pattern will be played and so on.

Select Patch 23 (Dance kit) as an example.  P. 20

Hit the head of the PD-7 connected to the **4/TOM1** and **5/TOM2** jack to play the sound. The first note of the Sequence Pattern will be played simultaneously with the sound. If you keep hitting the pad, every successive note of the sequence will be played.

⇨ A device that records and plays back performance data is called a “sequencer”. Sequence Patterns are performance patterns recorded in a sequencer.

⇨ To assign a Sequence Pattern Number to a pad, follow the procedure on page 41.

⇨ To create a new Sequence Pattern, follow the procedure on page 92.

[5] Patch Editing

The following example explains how to edit Patch 1 to change 126:Frozn.S to 132:Huge.S. First, select Patch 17.  P. 20

Be sure a PD-7 is connected to the 2/SNARE jack on the rear of the TD-7.

- 1 Press [EDIT] from the Patch Play screen.

```
(EDIT)PATCH|INST
P-CPY|I-CPY|GPFM
```

- 2 Move the cursor to PATCH using [◀] and [▶], then press [ENTER].

```
[P17]TRIG|FX|PGM
NOTE|PDL|NAME|PF
```

- 3 Move the cursor to NOTE using [◀] and [▶], then press [ENTER].

Note Number
↓

```
NOTE<#38>Sound1
Inst=126:Frozn.S
```

Change the Note number to 38 by hitting the rim of the pad connected to the 2/SNARE jack.

Or move the cursor to NOTE and select #38 with the [DATA] dial.

In the factory preset setting, "126:Frozn.S" is assigned to Note Number 38. Change this to "132:Huge.S".

- 4 Move the cursor to the Instrument Number (126) using [◀] and [▶].
- 5 Rotate the [DATA] dial to select "132:Huge.S"

Now, hit the pad connected to the 2/SNARE jack to confirm that "126:Frozn.S" has changed to "132:Huge.S".

For a detailed explanation about Instrument assignment, refer to page 78.

↳ "Editing" is the process whereby sound parameters or Patch settings are changed. 

* One of the following screens may be shown instead of the Sound 1 screen. If this happens, move the cursor to the far right on the first line in the screen, then select the Sound 1 screen (Sound1) using the [DATA] dial.

```
NOTE<#38>Sound2
Inst=512: off.E
```

```
NOTE<#38>Layer
OFF
```

```
NOTE<#38>JfTrig
JUMP to TRIG ?
```

* Two different Instruments can be assigned to each Note Number, but only one Instrument has been pre-assigned to Patch 17.

[6] The Patch Chain

The **Patch Chain** function allows you to arrange the 32 Patches in any order you like. You can then select them by pressing a footswitch or using [◀] and [▶].

As shown in the following figure, the first Patch will be selected after the last Patch (if you advance through a chain one Patch at a time).

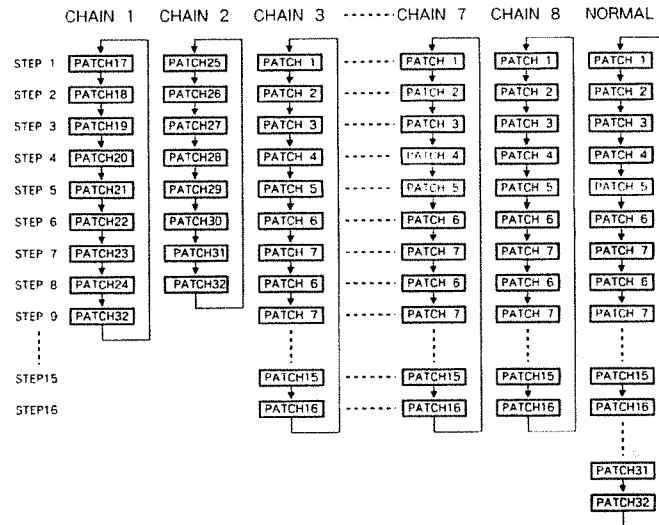

Each time the footswitch is pressed, the Patch Chain will advance by one number. (Using the cursor buttons, you can move in either direction.) The number of a step is called the **Step Number**. The last Step Number of a Patch Chain is called the **Step End Number**. The Step End Number can vary from 2-16. In the previous figure, the Step End Numbers of Chains 1 and 2 are 9 and 8 respectively.

You can select any one of 8 Patch Chains (CHAIN 1 - 8). When set to NORMAL, Patches 1 to 32 can be selected in order.

* The Patch Chain default setting is NORMAL.

■ Using the Patch Chain Function

- ① Press [ENTER] from the Patch Play screen. NORMAL is automatically selected.

```
(CHAIN SELECT)
NORMAL = -- STEP
```

- ② Rotate the [DATA] dial to select the Chain Number (1-8). Here, select CHAIN 1.

```
(CHAIN SELECT)
CHAIN1 = 9 STEP
```

Chain Number Step End Number

- ③ Press [EXIT] to return to the Patch Play screen.

Patch Number

```
1 7 7 August
1 1 Chn1 StP 1
```

Chain Number Step Number

- ④ Change Patches using [◀] and [▶] or a footswitch. Patches will be selected in the sequence set in CHAIN 1.

The preprogrammed Patch Chain (CHAIN1) order is 17→18→19→20→21→22→23→24→32.

■ Changing the order of the Patch Chain

- ① As explained above, select the Patch Chain to be edited.
- ② Press [EXIT] to return to the Patch Play screen.



- ③ Press [◀] and [▶] until the Step Number you wish to edit is selected. Select Step Number 3 for our example.



- ④ Rotate the [DATA] dial to select the Patch Number you wish to assign to the Step Number. Here, assign Patch Number 1 to Step Number 3.

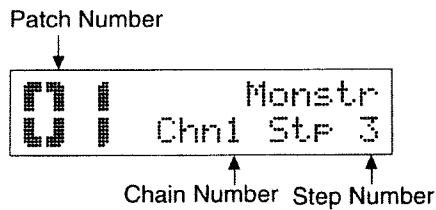

Now CHAIN 1 is arranged as follows:

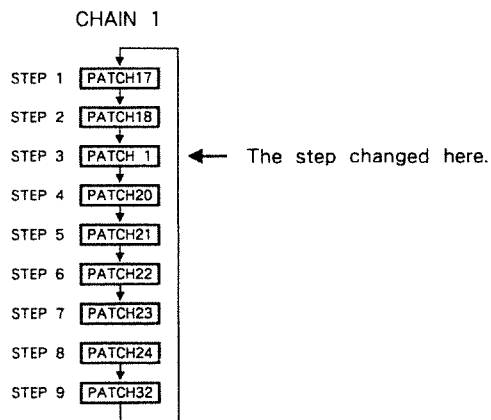

* The Patch order in NORMAL cannot be edited.

Chapter **2**

Basic Operation/Inside the TD-7

1. Basic Operation 30
2. Inside the TD-7 36

1. Basic Operation

[1] Setting Parameters

Basically, the parameters of the TD-7 are set as follows:

The following example shows how to set the MIDI channel.

- ① Be sure that the Patch Play screen is selected.

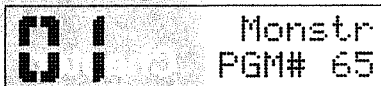

- ② Press [SYSTEM] to select the System screen. A menu will be displayed.

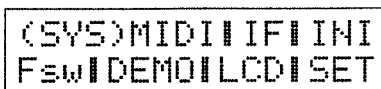
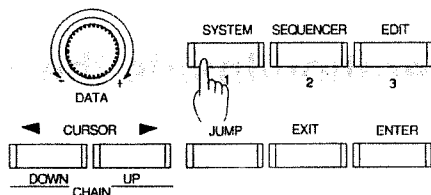

- ③ Move the cursor to the item you wish to select using [◀] and [▶].

To change MIDI channels, move the cursor to MIDI.

- ④ Press [ENTER].

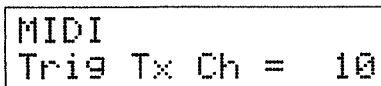

* If the display does not show the Patch Play screen, press [EXIT] until it is selected.

⌄ For a detailed explanation of the System screen, refer to page 34.

⌄ The characters at the cursor position will flash.

* The TD-7 contains four main screens: The Edit screen is selected by pressing the [EDIT] button. The Sequence screen is selected by pressing the [SEQUENCER] button. The System screen is selected by pressing the [SYSTEM] button. The Patch Play screen is the default. ⌄ P. 34

- ⑤ Since the cursor is positioned at `Trig Tx Ch`, you can select the parameter to be edited by rotating the [DATA] dial.

```
MIDI
Inst Tr Ch = 10
```

- ⑥ Press [▶] to move the cursor to the value field.
- ⑦ Rotate the [DATA] dial to change the value (MIDI channel number).

Now, a new MIDI channel has been set.

- ⑧ To return to the previous screen, press [EXIT].

This is the basic procedure for changing parameters. The Jump Function (explained below) can be used to speed up the process.

[2] The Jump Function

The Jump Function allows you to instantly jump (move) to any screen from any other screen.

■ How to jump

- ① Press [JUMP].

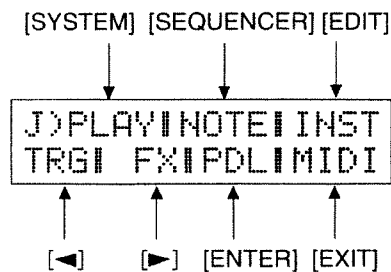

- ② Press the button to which the destination screen is assigned. For example, pressing [EDIT] will take you to the screen for editing an Instrument sound.

```
T2+N#38+S1+i138
Name <LAFat.S>
```

Changing the sound of an Instrument P. 78

To cancel the Jump, press [JUMP] again.

* Set `Trig Tx Ch` and `Inst Tr Ch` to the same channel number. (That channel number is generally set at 10) `Trig Tx Ch` and `Inst Tr Ch` have both been factory preset to channel 10.

⚠ If you keep pressing [EXIT], the Patch Play screen will ultimately be selected.

* If you press [JUMP], and then depress the footswitch, you can jump to the footswitch display.

The destination screen for each button is pre-assigned at the factory. You can, however, change this assignment.

- Destination screen selected by pressing [SYSTEM]

```
01 | Monstr  
01 | PGM# 65
```

Patch Play screen [P. 17](#)

- Destination screen selected by pressing [SEQUENCER]

```
NOTE<#92>Sound1  
Inst=075.Tight.K
```

Changing the sound assigned to the
Note Numbers in the Instrument section
[P. 49](#)

- Destination screen selected by pressing [EDIT]

```
T2→N#38→S1→i138  
Name <LAFat.S>
```

Editing the sound of an Instrument [P. 78](#)

- Destination screen selected by pressing [◀]

```
TRIG<T1>■■■■■■■■■■  
Note # =87:D#6
```

Editing the Trigger parameter [P. 41](#)

- Destination screen selected by pressing [▶]

```
Effect1 = Hall  
Out Level= 15
```

Editing the settings of the effects [P. 59](#)

- Destination screen selected by pressing [EXIT]

```
[P25]HiHat PEDAL  
Assign = TRIG 3
```

Editing the Hi-hat Control Pedal settings [P. 65](#)

- Destination screen selected by pressing [ENTER]

```
MIDI  
Trig Tx Ch = 10
```

Changing the MIDI parameters [P. 114](#)

■ Changing the Destination Screens

To change the destination screen you'll jump to ...

- ① Select the screen you wish to jump to.
- ② Press the key you wish to assign to the screen while holding [JUMP] down.

In the following example, [EDIT] is pressed while [JUMP] is held down.

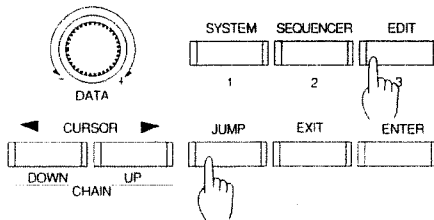

The indication flashes and the destination screen is changed. When the new value is different from the pre-assigned value, the display of the JUMP function changes to **USR**.

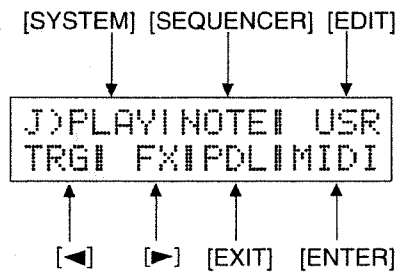

3. Main Screens

There are four **Main Screens** in the TD-7:

```

01 | Monstr
01 | PGM# 65
    
```

1 Patch Play Screen

```

(EDIT)PATCH|INST
P-CPY|I-CPY|GPFM
    
```

2 Edit Screen

```

(SEQ) PTN|TEMPO
SYNCA|AVAIL|METRO
    
```

3 Sequencer Screen

```

(SYS)MIDI|IFI|INI
Fsw|DEMO|LCD|SET
    
```

4 System Screen

These four screens represent the TD-7's four modes. Each main screen is a menu screen where various items are listed. For example, the Edit screen contains **PATCH**, **INST**, **P-CPY**, **I-CPY** and **GPFM**.

- 1 The **Patch Play** screen is used for playing data. This is the TD-7's default screen.
- 2 The **Edit** screen is for changing the values of sound parameters or altering a Patch in some way. Pressing **[EDIT]** from the Patch Play screen will select the Edit screen. The menu includes the following:

PATCH (Patch)	You can edit data in a Patch. ☞ P. 40
INST (Instrument)	You can change the sound of an Instrument. ☞ P. 78
P-CPY (Patch Copy)	You can copy the data in a Patch to another Patch or exchange data between two Patches. ☞ P. 71
I-CPY (Instrument Copy)	You can copy the sound of an Instrument to another Instrument or exchange data between two Instruments. ☞ P. 89
GPFM (Global Performance Parameters)	You can set the Global Parameters in the Performance Section. ☞ P. 73

☞ A "Patch" is a collection of sound settings (stored at a numbered memory location).

☞ "Editing" is the process whereby sound parameters or Patch settings are changed.

- 3 The **Sequencer** screen allows you to create performance patterns in the Phrase Sequencer. Pressing [SEQUENCER] from the Patch Play screen will select the Sequencer screen. The menu of this screen includes the following:

PTN (Pattern)	You can create and play performance patterns.	☞ P. 92
TEMPO (Sequence Tempo)	You can determine the tempo for data playback.	☞ P. 103
SYNC (Synchronization)	When the TD-7 is synchronized with other MIDI devices, you can determine whether it works as a 'Slave' device or a 'Master' device.	☞ P. 105
AVAIL (Available Memory)	The amount of memory available for storing performance data is displayed.	☞ P. 105
METRO (Metronome)	You can determine how the metronome should sound during recording and playback.	☞ P. 103

- 4 The **System** screen allows you to set the parameters related to the entire system of the TD-7; such as MIDI, LCD Contrast, Audio Output, Demo song playback, etc. Pressing [SYSTEM] from the Patch Play screen will select the System screen. The menu includes the following:

MIDI	You can set MIDI parameters, such as MIDI channel.	☞ P. 114
IF (Setting the Interface Mode)	You can determine the operational modes of TD-7.	☞ P. 123
INI (Initialize)	You can retrieve the factory preset data settings.	☞ P. 132
F _{SW} (Footswitch)	You can determine the function of the footswitch.	☞ P. 124
DEMO (Demo Songs)	You can play the demonstration songs.	☞ P. 19
LCD	You can adjust the LCD contrast.	☞ P. 18
SET (Sound Setup)	This determines how to output signals through the rear panel output jacks.	☞ P. 129

☞ A "sequencer" is a device which records and plays back performance data.

2. Inside the TD-7

The TD-7 is divided into 7 sections as shown below:

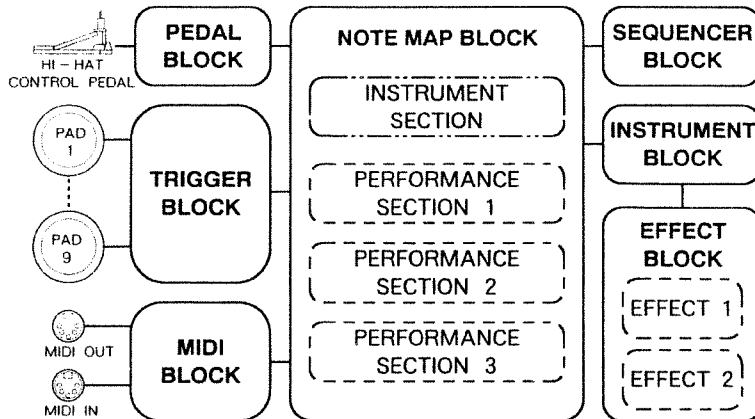

The **Trigger Block** converts the trigger signals (created by hitting the pads) into MIDI signals.

The **Instrument Block** determines the sound of an Instrument. The TD-7 contains 512 Instrument sounds which are made from the 256 waveforms.

The **Note Map Block** assigns an Instrument to each **MIDI Note Number**. That is, you can determine the Instrument to be played by hitting a pad or playing a connected keyboard. The **Instrument section** can provide one Note Map and the three **Performance sections** can provide one Note Map each. This creates a total of four Note Maps.

The **Pedal Block** determines how to control the sound module with the Hi-hat Control Pedal (FD-7).

The **Effect Block** processes the sound with the on-board effects (such as reverb and chorus). The Effect section contains two independent effects processors.

The **Sequencer Block** records data of the Phrase Sequencer and plays it back. MIDI signals sent from an external device can be recorded via the Note Map Block. Two effects can be used simultaneously.

The **MIDI Input / Output Block** sets the parameters related to transmitting and receiving MIDI messages.

⚡ A "Note Number" is the number assigned to each key of a keyboard.

⚡ A "Sequencer" is a device that records and plays back performance data.

⚡ "MIDI" stands for Musical Instrument Digital Interface, an international standard for communicating performance information or sound selection messages, etc.

[1] Parameters in a Patch

A Patch is a collection of sound settings (stored at a numbered memory location).

Various settings that determine how the sound should be played are stored in a **Patch**. A Patch is in turn stored in the internal **memory** of the TD-7. A Patch includes, among other things, Instrument and effect settings. The TD-7 can store up to 32 different Patches. By using a footswitch while a Patch is being played, you can instantaneously select a new Patch. The new Patch may have completely different sounds (and effects settings) for each pad.

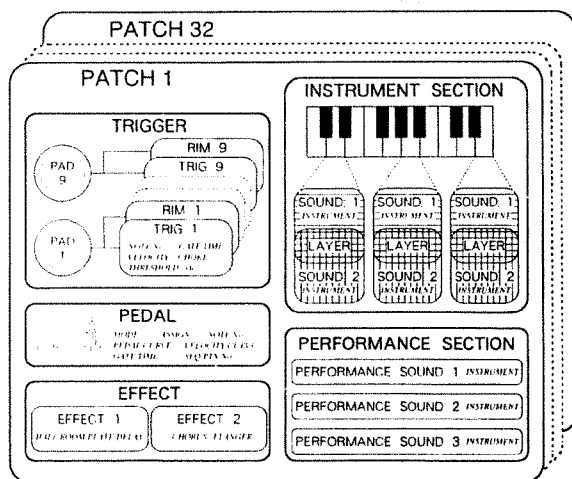

As you can see in the figure above, many different parameters can be written into a Patch. The following explains some important Patch parameters of the TD-7.

Two different **trigger signals** are output depending on how you strike the PD-7s; a signal created by **hitting the head of the pad** and a **Rim Shot** signal. (Remember, Rim Shot signals are created by hitting the head and rim sections of the pad at the same time.) Up to nine PD-7s can be connected to the TD-7, so a maximum of 18 trigger signals can be output.

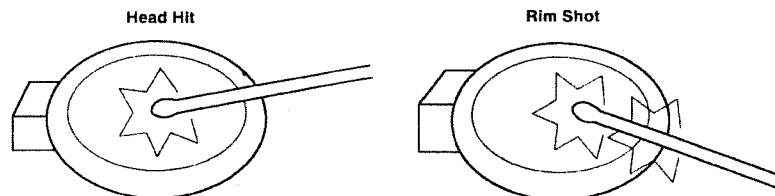

In a Patch, you can also set the Instrument assignment that determines which Instrument should be played by hitting a pad (or playing a connected keyboard). How the Instrument sounds differs in the **Instrument section** and the **Performance section**. The Instrument section assigns an Instrument to each Note Number and therefore each pad (key) will sound differently. In the Performance section, however, the same sound is assigned to each pad (key). In the Performance section, one Instrument sound is played with different pitches.

⚡ "Memory" is the place (memory IC) where data can be stored and retrieved.

* A Rim Shot is a performance technique in which both the actual pad and the rim of the pad are struck simultaneously. If you only hit the rim of the pad, the proper effect will not be obtained.

In the Instrument section, two Instruments are assigned to one pad (key). These two sounds are called **Sound 1** and **Sound 2**. The parameter called **Layer** can be used to determine how these sounds should be played. You can play two sounds simultaneously or change the tone quality depending on how hard you play the pads (keys).

Sounds can be selected from the Sound Group called "Instrument". The TD-7 contains 512 different Instrument sounds.

[2] Other Parameters

The parameters that can be written into the internal memory of the TD-7 are: **Instrument Sequencer** and **System** parameters.

An Instrument sound is created by one of the 256 **waveforms**. You can create your own Instrument sound by editing the parameters (such as the Pitch, Decay or Panning) of a particular waveform. The two **Effects** (Reverb, Chorus, etc.) can be used to further change the sound.

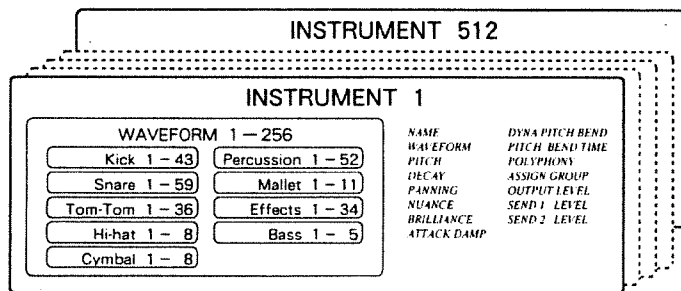

The **Sequencer** parameters are for recording and playing back the data of the **Phrase Sequencer**. The **System** parameters are related to settings of the entire system of the TD-7, such as MIDI, Output Assign, LCD, etc.

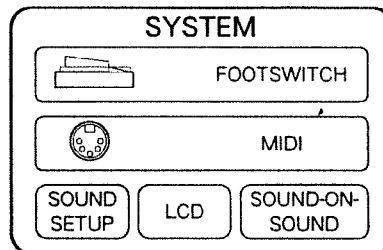
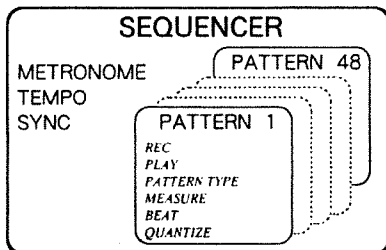

Chapter **3**

Patch Setting

1.Setting A Patch 40
2.Patch Copy 71
3.Grobal Performance Parameters 73



1. Setting a Patch

The following chapter explains how to set the parameters that can be stored in a Patch (1-32). These parameters include those for the Patch Name, the 9 Trigger Inputs, the Instrument Section, the Hi-hat Control Pedal, the Effects, the Performance Sections and Program Change Numbers.

[1] Naming a Patch

You can name a Patch using up to 6 characters. The currently selected Patch is displayed in the Play mode.

- 1 Select the Patch Play screen, then Press [EDIT].

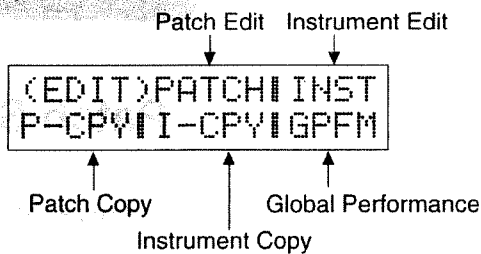

- 2 Move the cursor (using [◀] and [▶]) to PATCH, then press [ENTER].

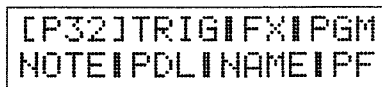

- At this stage, you can change Patch Numbers by rotating the [DATA] dial.

- 3 Move the cursor (using [◀] and [▶]) to NAME, then press [ENTER].

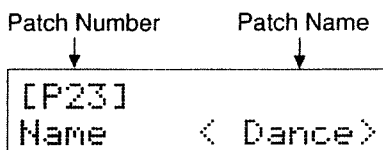

- 4 Move the cursor (using [◀] and [▶]) to the Patch Number field, then select the Patch Number you wish to name using the [DATA] dial.
- 5 Move the cursor (using [◀] and [▶]) to the Patch Name field and start creating the Patch name.
- 6 Select the first character in the new name using the [DATA] dial.
- 7 Press [▶] to move to the next character space. Select the second character.
- 8 Proceed in this manner until the name is complete.
- 9 Press [EXIT] three times to return to the Patch play screen.

For a detailed description of the Patch Play screen, see page 17.

[2] Assigning a Note Number to a Trigger Signal

The TD-7 is equipped with 9 Trigger Input jacks. Using the specified pads (PD-7; optional), 18 Trigger Signals can be controlled. Each PD-7 can output a Rim Shot signal (in addition to the standard center-of-head signal) when the rim and head of the pad are played simultaneously. Therefore, when 9 PD-7s are used, 18 Trigger Signals (2 from each pad) are possible.

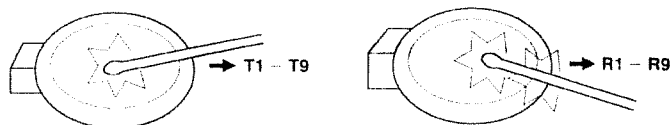

The following describes how to assign a MIDI Note Number to each Trigger Signal.

The symbols T1 - T9 shown in the screen represent the Trigger Signals created when the head of a pad is hit. R1 - R2 represent the Trigger Signals output when you play Rim Shots.

Assign a MIDI Note Number (35-93) to each Trigger Signal. The sound module of the TD-7 will be played according to the assigned Note Number. The sound or pitch that corresponds to the assigned Note Number will be heard depending on whether the Instrument or Performance section is being used. In the **Instrument Section**, a different sound (Instrument) is assigned to each MIDI Note Number and therefore different sounds will be heard by playing different pads. In the **Performance section**, however, the 'set sound' will be played at the pitch of the MIDI Note Number that is output from the pad.

Playing a pad will output the message of the set MIDI Note Number through the MIDI OUT connector on the rear of the unit.

Correspondence between Note Numbers and Names

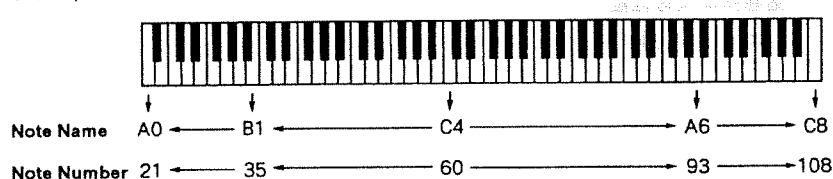

⚡ A "Trigger Signal" is an electric impulse generated by hitting a pad. The TD-7 can detect the timing and strength (velocity) of the Trigger Signal via high speed signal processing.

⚡ A "Note Number" is the number assigned to each key on a keyboard.

⚡ For a detailed explanation of how to set the transmit channel for MIDI messages created by playing a pad, refer to page 115.

[3] Setting Various Trigger Parameters

The following parameters can be set for the Trigger Signals of each pad. You can set them in a similar way as in "2. Assigning a Note Number to a Trigger Signal" (P. 41).

- Gate Time : Gate Time (0.1- 4.0 sec)

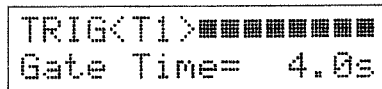

The Gate Time determines the actual length of time an Instrument will sound when a pad is played. Gate Time is equivalent to the time from Note On to Note Off when you play a MIDI keyboard.

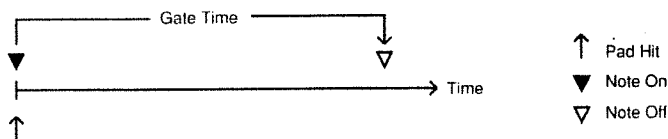

If, for example, the Gate Time set for a pad is fairly long (1 or 2 seconds), every time you strike the pad, you will cutoff the previous sound and trigger a new one.

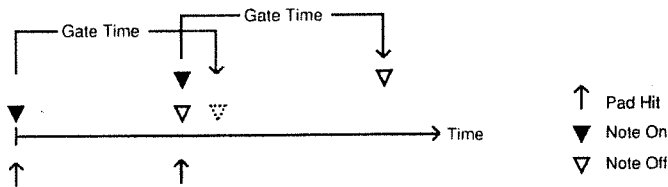

Many drum machines and percussion sound modules cannot recognize Note Off messages. Therefore, it is recommended that you set the TD-7 to ignore Note Off messages.

If you set the "Note Off Receive Switch" to ON (P. 117), the TD-7 can recognize Note Off messages. When the Gate Time (duration from Note On to Note Off) the TD-7 receives is longer than the Gate Time set for the internal sound module, the sound will stop even before Note Off messages are received. (See figure a below). When the received Gate Time is shorter, the Note Off messages will be recognized when received. (See figure b below.)

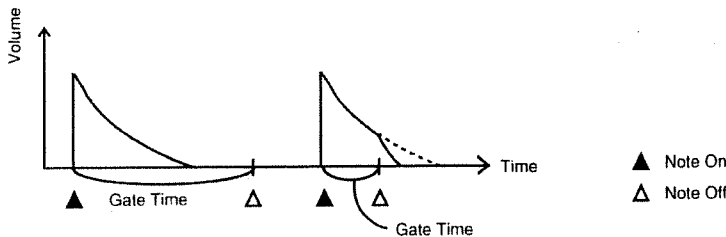

Fig. a

Fig. b

⚡ The TD-7's default setting is "Note Off Receive Switch" OFF.

⚡ The Gate Time of the internal sound module can be set with the Decay of the Instrument in the Edit screen. ⚡ P. 83

● Cross Talk Cancel Group : CrsTlkGrp (1- 4 / OFF)

```
TRIG<T1>■■■■■■■■■■
CrsTlkGrp= OFF
```

When several pads are set close together, the vibrations caused by striking one pad may inadvertently trigger the sounds of other pads. The 'Cross Talk Cancel Group' prevents such errors.

Assign all the pads in a group (the pad played and those affected by the vibrations) the same number (Cross Talk Cancel Group = ON). To turn off this function, set to OFF.

● Velocity Sense Curve : VelCurve (NORMAL1/2/3/4/FIX32/64/96/127)

```
TRIG<T1>■■■■■■■■■■
VelCurve = Norm4
```

The **Velocity Sense Curve** represents the 'strength' with which each pad is played. When set to "NORMAL" (NORM), the volume will increase by playing harder. There are 4 NORMAL curves. (See figure a below.) When "FIX" (FIX) is selected, the volume will not be affected by playing strength (ie. the volume remains constant). There are 4 FIX curves with different velocity values. (See figure b below.)

ⓘ The volume of the TD-7's internal sound source depends upon the received velocity value.

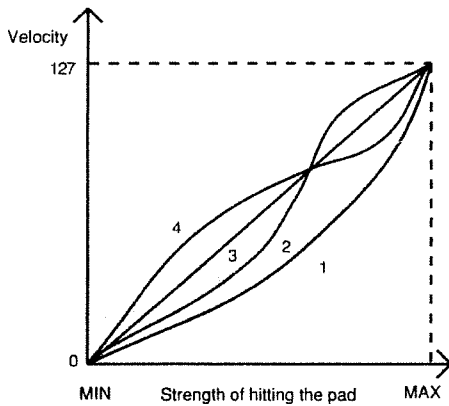

Fig. a

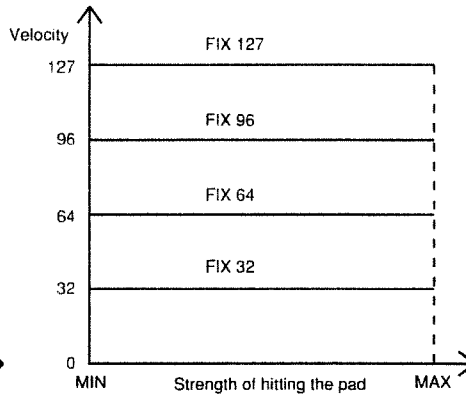

Fig. b

● Sequence Pattern Number : SeqPtn # (OFF / 1-48)

```
TRIG<T1>■■■■■■■■■■
SeqPtn # = 24
```

Hitting a pad will trigger the assigned Sequence Pattern. The Sequence Pattern will also be triggered by receiving a MIDI Note On message. When set to OFF, no Sequence Pattern will be played. 1-24 are User Patterns and 25-48 are Preset Patterns.

● Choke : Choke (ON/OFF)

```
TRIG<T1>■■■■■■■■■■
Choke      =      ON
```

The Choke effect (for cymbals, etc.) can be obtained when using PD-7 pads. The Choke effect mutes the sound when the rim of the pad is touched or grabbed. When it is set to OFF, the Choke effect cannot be obtained.

● Automatic Parameter setting : Auto (MIN3→MAX3)

```
TRIG<T1>■■■■■■■■■■
Auto: MIN 3times
```

Slowly strike a pad six times—three times softly, three times strongly—according to the message shown in the display. The following parameters (Max Dynamic/Minimum Dynamic/Mask Time/Threshold Level) will be set automatically. If you continue hitting the pad, the display will change as shown below:

```
MIN 3times → MIN 2 more → MIN 1 more → MAX 3times
→ MAX 2 more → MAX 1 more → SET OK !
```

```
TRIG<T1>■■■■■■■■■■
Auto: SET OK !
```

If you do not succeed, move the cursor using [◀] and [▶], select a different Parameter screen with the [DATA] dial, select the Auto screen again, and then hit the pads.

This procedure allows you to set the maximum and minimum volume levels obtained from the pads. That is, playing harder than the set maximum volume level will not increase the volume. Similarly, playing softer than the set minimum level will not decrease the volume.

◦ If you hit the pad while grabbing hold of the rim, decay will be shortened. It can be simulated the Mute Triangle effect.

* If you wish to change the maximum and minimum levels, repeat the procedure or edit the following parameters (Max Dynamic/Minimum Dynamic/Mask Time/Threshold Level).

● Max Dynamic / Minimum Dynamic : Max Dyna / Min Dyna (1 - 16)

```
TRIG<T1>■■■■■■■■■■
Max Dyna = 16
```

```
TRIG<T1>■■■■■■■■■■
Min Dyna = 16
```

Playing dynamics vary from player to player, and the level of Trigger Signals vary from pad manufacturer to pad manufacturer. The Max Dynamic and Minimum Dynamic settings compensate for such differences and maintain a maximum **dynamic range**.

To set the Max and Minimum Dynamics, specify the Trigger Signal level of the pads that corresponds to the maximum and minimum values of the MIDI Velocity.

When your playing velocity is low (ie. you're playing softly) or the Trigger Signal level of the pads is low, set the Max and Minimum Dynamic fairly low.

Any Trigger Signal above the level set with the Max Dynamic will be regarded as Velocity 127.

Any Trigger Signal lower than the level set with the Minimum Dynamic will be regarded as the Velocity value set with the Minimum Velocity referred to in the following parameter.

● Minimum Velocity : Min Velo (1- 64)

```
TRIG<T1>■■■■■■■■■■
Min Velo = 64
```

You may at times wish to maintain a minimum volume level even when playing very softly. Minimum Velocity sets this volume level.

Any Trigger Signal lower than the level set with the Min Dynamic is regarded as the Velocity value set here. Velocity value can be set over 16 steps. The figure shown in the display represents the MIDI velocity value.

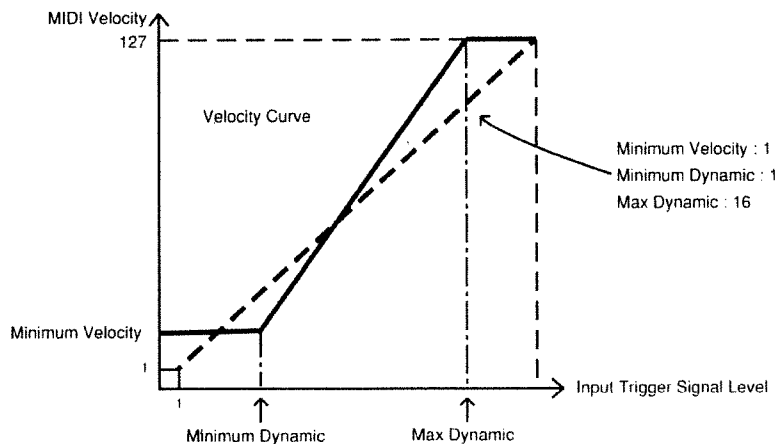

∴ "Dynamic range" is the difference between the maximum and minimum volume levels.

∴ The volume of the TD-7's internal sound module is determined by the Velocity value set here.

● Mask Time : Mask Time (0-124ms)

```
TRIG<T1>■■■■■■■■■■
Mask Time= 24ms
```

This parameter should be set for pads that tend to create **double triggers**, such as the kick pedal. Even when more than one Trigger Signal is created within the set time, the latter signal will be ignored. In the figure below, Trigger Signals ① and ③ will cause the sound to be played, while signal ② will not. The time can be set in 4 msec steps.

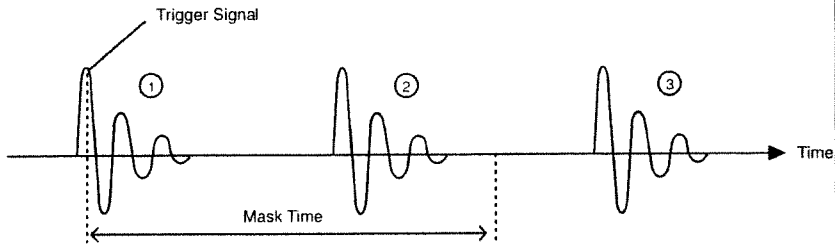

● Threshold Level : Threshold (1-16)

```
TRIG<T1>■■■■■■■■■■
Threshold= 16
```

When the level of the Trigger Signal sent from a pad is lower than the set threshold level, no sound is heard. Using this feature, you can prevent the vibrations from the pad being played from generating Trigger Signals in adjacent pads. In the figure below, Trigger Signal ② will cause the sound to be played while signals ① and ③ will not.

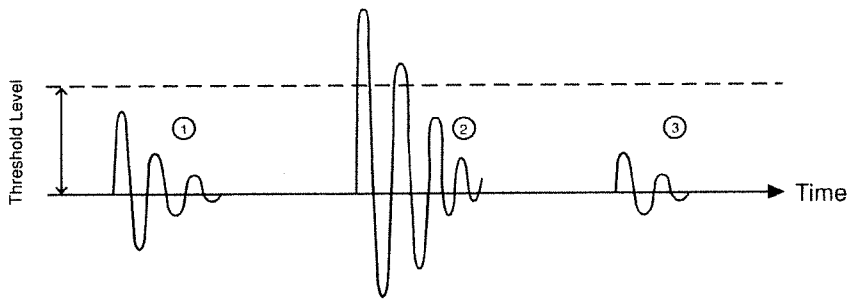

! A "Double trigger" occurs when two (or more) Trigger Signals are generated when only one was intended.

[Useful Functions for setting Trigger Parameters]

The following explains "Jump To Note" and "Preview Key". These functions will speed up the process of sound editing and monitoring when you set the Trigger Parameters.

■ Jump To Note

When you are setting Trigger parameters, you can use the Jump To Note function to change the Instrument assigned to a Note Number. Using this function, you can quickly select the Note screen (as you need not retrieve the Basic screen by pressing [EXIT]).

- ① Select the Trigger Parameter setting screen, then press [ENTER].
The display responds with Are you sure?.

```
Are you sure ?  
JUMP to NOTE #
```

- ② Press [ENTER] to select the screen for assigning an Instrument to a Note Number.
To cancel the Jump To Note mode, press [EXIT].

■ Preview Key

When you are in the Trigger Parameter setting screen, [1]([SYSTEM]), [2]([SEQUENCER]) and [3]([EDIT]) will become Preview Keys. That is, even if no pad or MIDI device is connected to the TD-7, pressing these keys will trigger the TD-7's sounds. [1]([SYSTEM]) triggers a soft sound (velocity value 32), [2]([SEQUENCER]), a medium level sound (velocity value 64), and [3]([EDIT]), a loud sound (velocity value 127).

* When the cursor is positioned at Level Meter (or Velocity Value), Jump To Note cannot be used.

[4] Instrument Section

The **Instrument Section** allows you to assign an Instrument to each Note Number. That is, each Trigger Signal will play a different Instrument. If you wish to assign a different sound to each pad, use the Instrument Section.

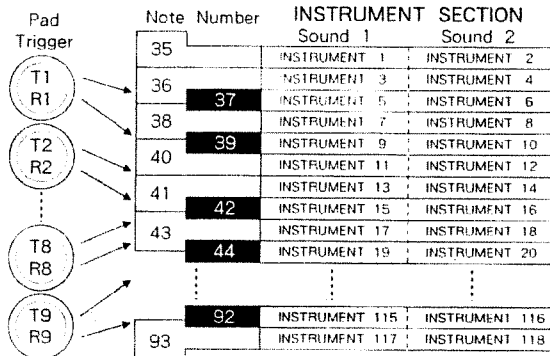

⚡ The Instrument Section is similar to the "Drum Part" (or Rhythm Part) in a MIDI multi-timbral sound module. It is also similar in that a different sound is heard from each key on a MIDI keyboard.

a. Setting Sounds 1 and 2

You can assign two different Instruments to one Note Number to create various mixing effects. This is called "Layer". The two Instruments are called **Sound 1** and **Sound 2**.

A different **Pitch** can be set for both Sound 1 and Sound 2. The pitch is variable in semi-tone (100 cent) steps, from -4800 to +4800 cents.

⚡ For a detailed explanation of setting Layers, refer to page 52.

⚡ A "Cent" is a unit of pitch. 1 cent is 1/100th of a semi-tone.

■ Setting the Instrument and Pitch

- ① Select the Patch Play screen, then press [EDIT].
- ② Move the cursor to PATCH, then press [ENTER].



- At this stage, you can change Patch Numbers by rotating the [DATA] dial.

- ③ Move the cursor to NOTE, then press [ENTER].

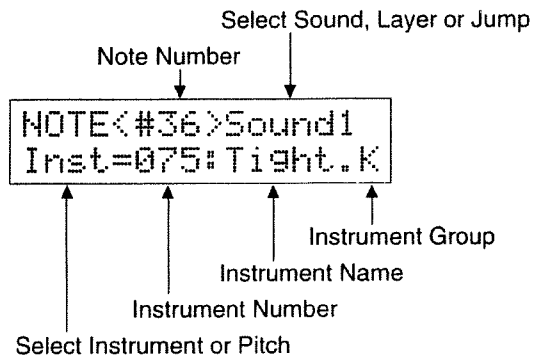

Move the cursor to the Note Number, then select a Note Number using the [DATA] dial. If you press [ENTER] here, the screen shows the Note Name instead of Note Number. Pressing [ENTER] again will retrieve the Note Number display.

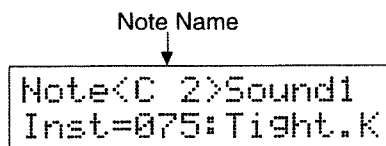

* One of the following screens may be shown instead of the Sound 1 screen. If this happens, move the cursor to the far right on the first line in the screen, then select the Sound 1 screen (Sound1) using the [DATA] dial.

```
NOTE<#36>Sound2
Inst=037: Huge.K
```

```
NOTE<#36>Layer
OFF
```

```
NOTE<#36>JeTri9
JUMP to TRIG ?
```

- ④ Select the Instrument to be assigned by rotating the [DATA] dial.

When you move the cursor with [◀] and [▶], Note Number **Sound1**, Inst. **075**, **Tight** and **K** will flash. To change the values, move the cursor to the relevant position, then rotate the [DATA] dial.

Depending on the cursor position, different parameters can be edited.

<#36> The Note Number can be edited.

Sound1 You can set the following parameters by moving the cursor to this position and rotating the [DATA] dial.

Sound 1 **Sound1** : You can adjust the settings for Sound 1.

Sound 2 **Sound2** : You can adjust the settings for Sound 2.

Layer **Layer** : You can adjust the settings for Layer. ⇨ P. 52

Jump To Trigger **JPTri9** : You can jump to the screen for setting Trigger Parameters. ⇨ P. 55

Inst You can select the desired Instrument. You can change the pitch of the Instrument by selecting Pitch using the [DATA] dial. The variable range of the pitch is -4800 - +4800 cents. The pitch can be changed in semi-tone (100 cents) steps.

```
NOTE<#36>Sound1
Pitch = -4800
```

075 You can select an Instrument with the corresponding number, from 1-512.

Tight You can select an Instrument with the corresponding name.

K You can select an Instrument with the corresponding group name.

- Hitting a pad will automatically select the MIDI Note Number assigned to the Trigger signal of that pad.
- As the TD-7 receives the MIDI Note messages, the received MIDI Note Number will be automatically selected.
- If you select **Sound2** in step ④, you can set the parameters for Sound 2.

⇨ The name and the group name of the Instrument can be set easily. ⇨ P. 82

⇨ Be sure to set the receive and transmit MIDI channels to the same number.

b. Layer

Layer allows you to play two different Instruments, Sound 1 and Sound 2, simultaneously. If Layer is set to OFF, only Sound 1 will be played.

There are five types of Layers:

Velocity Mix (1-8) Velo Mix

The two sounds assigned to a pad are mixed in different proportions depending on how hard you play. With a low setting value (say 1 or 2), only Sound 1 is heard when you play very softly. Both sounds are heard when you play at a moderate or high level. At a higher setting value (7 or 8), Sound 2 is mixed with Sound 1 only when you play very hard. The overall output level is determined by how hard you play the pad.

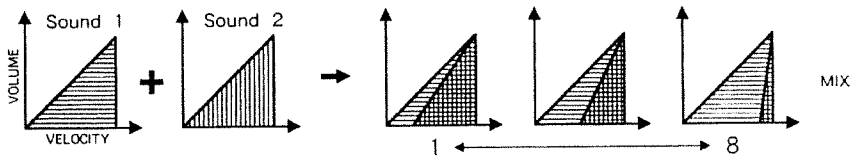

Velocity Switch 1 (1-8) Velo Sw 1

With this Layer setting, only one sound is heard at a time. The sound that is heard is determined by how hard you play the pads. At a low setting value (1 for example), only Sound 1 is heard when you play softly. At the same setting, only Sound 2 is heard when you play at moderate or high levels. If you change the setting to 8, for example, Sound 2 is heard only if you play the pads very hard.

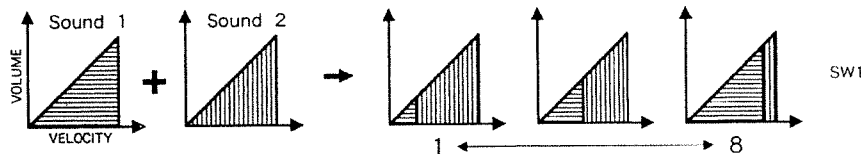

Velocity Switch 2 (1-8) Velo Sw 2

With this Layer setting, as with the Velocity Switch setting, only one of the two sounds is heard at a time. However, here the overall volume output is fixed and is not affected by your playing strength. That is, playing strength determines which sound is heard, not the volume level. When a smaller value is set (say 1 or 2), only Sound 1 is heard when you play softly. At a higher setting (7 or 8), Sound 2 is heard only when you play very hard. Keep in mind that the actual volume level heard will be constant regardless of how hard you play—playing strength determines the sound heard, not the output volume.

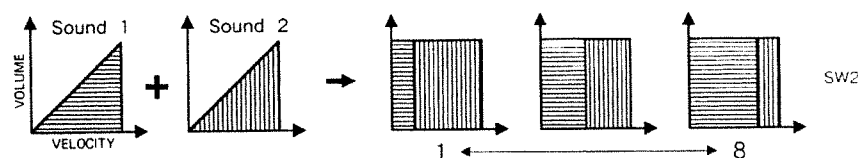

* When the Layer function is being used, two sounds are played by one Note ON message. Although the TD-7 can play up to 14 notes at once, this number will be reduced when using the Layer function. If this causes problems for you, set the Layer parameter of some Instruments to OFF.

[Useful Functions for Editing the Instrument Section]

The following explains the "Jump To Instrument", "Jump to Trigger" and "Preview" functions. These functions speed up the process of editing sounds, checking the Trigger Signals and monitoring in the Instrument Section.

■ Jump To Instrument

When you are assigning Instruments to Sounds 1 and 2, you can use this function to edit the sounds by changing the parameters (such as Decay). Using this function, you can quickly select the sound editing screen (without having to retrieve the Basic screen by pressing [EXIT]).

From the Sound 1 / Sound 2 Instrument setting screens, or the Pitch setting screen:

- ① Press [ENTER].

The screen responds with Are you sure ?

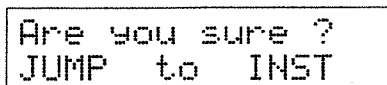
A screenshot of a screen with a black border. The text on the screen is displayed in a pixelated font. The first line reads "Are you sure ?" and the second line reads "JUMP to INST".

```
Are you sure ?  
JUMP to INST
```

- ② Press [ENTER] again to select the sound editing screen for an Instrument. Begin editing.

To cancel the Jump To Instrument mode, press [EXIT].

■ Jump To Trigger

In the Instrument Section, you assign an Instrument to a Note Number. However, you cannot tell which pad should be hit for the desired Instrument unless you watch the Trigger Parameter screen (P. 42). Using the Jump to Trigger function, you can instantaneously move to the Trigger Parameter screen from the Instrument Section screen.

- ① Select the Patch Play screen, then press [EDIT].
- ② Move the cursor to PATCH Using [◀] and [▶], then press [ENTER].

```
[P32]TRIG|FX|PGM
NOTE|PDL|NAME|PF
```

- If you move the cursor to the Note Number using [◀] and [▶], you can change the Note number using the [DATA] dial.

- ③ Move the cursor to NOTE using [◀] and [▶], then press [ENTER].
- ④ Select J=Trig using the [DATA] dial. ☞ P. 50

```
NOTE<#92>J=Trig
JUMP to TRIG ?
```

- ⑤ Press [ENTER].

The screen responds with Are you sure ?

- ⑥ Press [ENTER] again to select the Trigger Parameter screen. If you wish to cancel the Jump To Trigger mode, press [EXIT] instead of [ENTER].

If the Note Number currently selected is not assigned to any Trigger, the following message appears. The previous display is then recalled.

```
Not assigned !
```

■ Preview Key

When the Instrument Section screen is selected, the 1 [SYSTEM], 2 [SEQUENCER] and 3 [EDIT] buttons will work as Preview Keys. That is, even if no pad or MIDI device is connected to the TD-7, pressing these keys will trigger the TD-7's sounds. 1 [SYSTEM] triggers a soft sound (velocity value 32), 2 [SEQUENCER], a medium level sound (velocity value 64), and 3 [EDIT], a loud sound (velocity value 127).

☞ Patch Play screen
☞ P. 17

[5] Performance Sections

In a Performance Section, one Instrument sound is assigned to all the pads, with each pad playing a different pitch. With this arrangement you can play melodies. Also, using a MIDI keyboard, you can play melodies from a Performance Section. That is, a Performance Section is similar to a "Standard Part" in a MIDI multi-timbral sound module. The TD-7 contains three Performance Sections and therefore can be used as a 4-part, multi-timbral sound module.

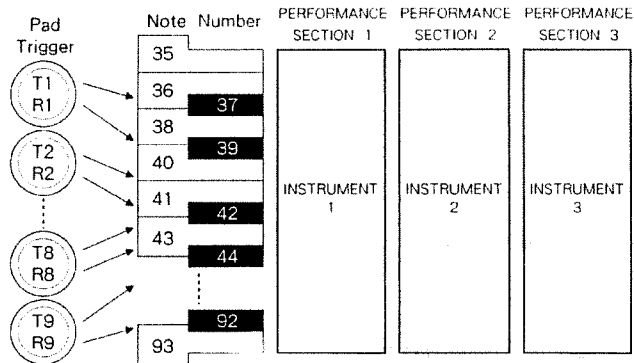

∴ In some sound modules, a "Standard Part" is called a "Normal Part".

∴ For a detailed explanation of parameter settings in the Performance Sections, refer to page 73.

■ Sound Settings in the Performance Sections

There are three Performance Sections (PFM1, PFM, PFM3) in the TD-7. You can assign any one of the 512 Instruments to each Performance Section.

- ① Select the Patch Play screen, then press [EDIT].
- ② Move the cursor to PATCH (using [◀] and [▶]), then press [ENTER].

```

CP32]TRIG|FX|PGM
NOTE|PDL|NAME|PF
    
```

- If you wish to change Patch Numbers, rotate the [DATA] dial.

∴ Parameters related to the entire Performance Section should be set in Global Performance Parameter (page 73).

● Sound Setting in Performance Section 1

- ③ Move the cursor to PF (using [◀] and [▶]), then press [ENTER].

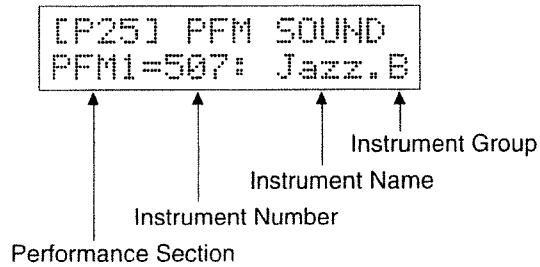

- ④ Select the Instrument to be assigned using the [DATA] dial.

Move the cursor to PFM1, 507, Jazz or B and change the value if you wish.

● Sound Setting in Performance Section 2

- ⑤ Move the cursor to PFM1 (with [◀] and [▶]), then change it to PFM2 with the [DATA] dial.

The screenshot shows a two-line display: [P25] PFM SOUND and PFM2=430: MarIL.M.

- ⑥ Move the cursor with [◀] and [▶], then edit the value with the [DATA] dial.

● Sound Setting in Performance Section 3

- ⑦ To select the Instrument to be assigned to Performance Section 3, select PFM3 in step ⑤.

The screenshot shows a two-line display: [P25] PFM SOUND and PFM3=431: MariU.M.

* Depending on the patch selected, what appears in the screen will be different. The left screen will be shown, when you select the Patch 25 (Standard kit).

[Useful Functions for Editing a Performance Section]

The following explains “Jump To Instrument” and “Preview Keys”. These functions speed up the process of editing the sound in a Performance Section.

■ Jump To Instrument

When you are assigning an Instrument to a Performance Section, you can use the Jump To Instrument function for editing sounds by changing parameters (such as Decay). Using this function, you can instantaneously move to the Sound Editing screen.

Select the Instrument Setting screen for a Performance Section and then:

- ① Press [ENTER].
The screen will respond with Are you sure ?

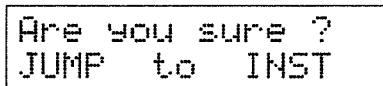

```
Are you sure ?
JUMP to INST
```

- ② Press [ENTER] again to select the screen for Instrument editing, then edit the Instrument.
To leave the mode, press [EXIT].

■ Preview Keys

When you are in the Performance Section screen, the 1 [SYSTEM], 2 [SEQUENCER] and 3 [EDIT] buttons work as Preview Keys. That is, even if no pad or MIDI device is connected to the TD-7, pressing these keys will trigger the TD-7's sounds. 1 [SYSTEM] triggers a soft sound (velocity value 32), 2 [SEQUENCER], a medium level sound (velocity value 64), and 3 [EDIT], a loud sound (velocity value 127).

[6] Effects

The TD-7 includes two Effects: **Effect 1** and **Effect2**. Using these Effects, you can enhance the TD-7's sounds. It is possible to apply two Effects to one Instrument at the same time.

Four different effects are provided in Effects 1 and 2. These are the Effect Types :

- **Reverb** simulates the reverberation (sound reflections) in a large enclosed space (a concert hall for example). This creates rich and natural sounds. You can change the quality of reverb sound (with Reverb Type), the size of the space (with Reverb Time) and the level of the reverberation sound (with Output Level).
- **Delay** creates an **Echo** like effect by delaying the sound output. You can set different delay times for the right and left channels (when using a stereo output).
- **Chorus** is an effect that makes the sound fatter and warmer. It can also create distortion or vibrato effects by changing the volume and pitch of the sound. You can adjust the speed of the modulation (with Rate) and the depth (with Depth).
- **Flanger** is an effect that makes the sound fatter and brighter, making it even more unusual than with Chorus.

Effect Types Available for Effect 1

	Type	Effect Description
Reverb	HALL	This setting simulates the reverberation in a large space like a concert hall.
	ROOM	This setting simulates the reverberation in a smaller space.
	PLATE	This setting creates a Plate Echo effect: a bright, metallic sound.
Delay	DELAY	This setting generates discreet reflections, like those of an echo.

Effect Types Available for Effect 2

Type	Effect Description
CHORUS	This effect makes sounds fatter and warmer.
FLANGER	This effect makes sounds fatter and brighter—more unusual than those of the Chorus effect.

* No effects will be obtained when using the Individual Outputs. Please read "Sound Setup" on page 129 carefully.

⚠ A "Plate Echo" is a device that creates its effect from the vibrations of a suspended metal plate.

■ Selecting an Effect Type and Setting Parameters

- ① Select the Patch Play screen, then press [EDIT].
- ② Move the cursor to PATCH, then press [ENTER].

```
[P32]TRIGIFXIPGM
NOTEIPDLNAMEIPF
```

- If you wish to change Patch Numbers, rotate the [DATA] dial.

- ③ Move the cursor to FX, then press [ENTER].

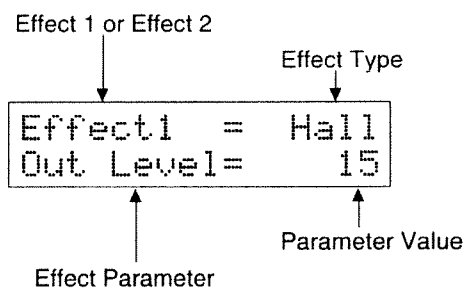

- ④ Move the cursor to the Effect 1, 2 field, then select Effect1 with the [DATA] dial.
- ⑤ Move the cursor to the Effect Type field, then select the Effect Type for Effect1.
- ⑥ Move the cursor to the Effect Parameter field, then select the Effect Parameter for Effect1.
- ⑦ Move the cursor to the parameter value field, then set the value with the [DATA] dial.

- To set Effect 2, select Effect2 in step ④ (Page 60).

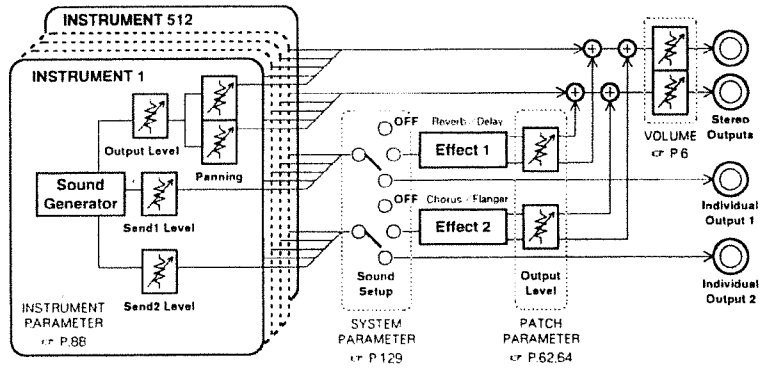
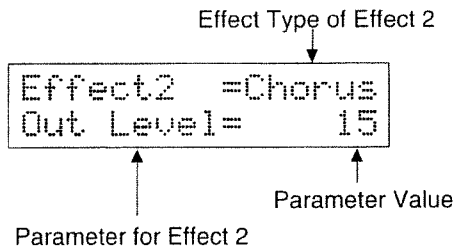

There are many Effects Parameters, each of which can be edited in step ⑥-⑦ (page 60).

a. Parameters for Effect 1

Effect 1 includes Reverb and Delay.

● Output Level : Out Level (0 - 15)

```
Effect1 = Hall
Out Level = 15
```

This parameter adjusts the volume of the effect sound. This is the equivalent of the Effect Return Level of a mixer. Higher values will increase the volume of the effect sound. When set to zero, no effect sound is output.

● Reverb Time : Rv Time (0-5) (Available only for Reverb)

```
Effect1 = Hall
Rv Time = 15
```

This is the reverberation decay time. Higher values will make the reverberation time longer, simulating larger spaces.

● Pre Low Pass Filter : Pre LPF (0 - 15)

```
Effect1 = Hall
Pre LPF = 15
```

This is the low-pass filter for cutting the higher frequencies of the direct sound fed into the Effect. You can control the cutoff frequency of the low-pass filter by changing the values for the Pre Low Pass Filter. Higher values will lower the cutoff frequency, creating a warmer sound.

* Available parameters differ depending on which Effect Type (Reverb or Delay) is selected.

* If INDIVIDUAL 1 or OFF is selected (for Send 1) in "Sound Setup" (page 129), Effect 1 (Reverb, Delay) cannot be used.

- Delay Right Time/Delay Left Time : RightTime / Left Time (2 - 450ms)
(Available only for Delay)

```
Effect1 = Delay  
RightTime= 450ms
```

```
Effect1 = Delay  
Left Time= 450ms
```

This setting determines the delay time for each channel (in 2ms steps).

- Feedback : Feedback (0-15) (Available only for Delay)

```
Effect1 = Delay  
Feedback = 15
```

This parameter determines the amount of delay sound to be returned to the Effect input. Higher values will increase the number of delay repeats.

b. Parameters for Effect 2

Effect 2 includes Chorus and Flanger.

- Output Level: Out Level (0-15)

```
Effect2 =Chorus
Out Level= 15
```

This parameter adjusts the volume of the effect sound. This is equivalent to the Effect Return Level of a mixer. Higher values will increase the volume of the effect sound. When set to 0, no effect sound is output.

- Rate : Rate (0 -31)

```
Effect2 =Chorus
Rate = 31
```

This parameter adjusts the Chorus or Flanger modulation speed. Higher values increase the speed.

- Depth : Depth (0 - 15)

```
Effect2 =Chorus
Depth = 15
```

This parameter adjusts the Chorus modulation depth. Higher values increase modulation depth.

- Feedback : Feedback (0 - 15) (Available only for the Flanger)

```
Effect2 =Flange
Feedback = 15
```

This parameter sets the amount of Flanger feedback. Higher values accentuate the Flanging effect.

- Delay Time : DelayTime (1 - 30ms) (Available only for the Flanger)

```
Effect2 =Flange
DelayTime= 30ms
```

This parameter adjusts the delay time of the effect sound. Higher values will increase the delay time. A longer delay time will automatically lower the center frequency of the flanging effect, while a shorter delay time will raise it.

* Available parameters differ depending on which Effect Type (Chorus or Flanger) is selected.

* If INDIVIDUAL 2 or OFF is selected (for Send 2) in "Sound Setup" (page 129), Effect 2 (Chorus, Flanger) cannot be used.

†: In some devices, "Feedback" is called "Resonance".

†: In some devices, "Delay Time" is called "Manual".

[7] Hi-hat Control Pedal

The TD-7 allows you to control sound parameters using the FD-7 Hi-hat Control Pedal. For example, you can modify the Decay, Pitch and Nuance of a sound using an FD-7.

The Control Mode (Patch Number 1 to 25) of the Pedal has been set to Hi-hat 1 at the factory, allowing you to control both the Open and Closed Hi-hat sounds.

By assigning Note Number to the Pedal, you can play the desired Instruments by pressing the Pedal. The Decay is controlled by how far you press the Pedal. You can also use the Pedal to trigger Sequence Patterns.

■ How to Set the Pedal Parameters

- ① Select the Patch Play screen, then press [EDIT].
- ② Move the cursor to PATCH, then press [ENTER].
- If you wish to change Patch Numbers, rotate the [DATA] dial.

- ③ Move the cursor to PDL, then press [ENTER].

```
[P25]HiHat PEDAL  
Assign = TRIG 3
```

↑ ↑
Parameter Value field

- ④ Move the cursor to the parameter name field and select the parameter you wish to edit with the [DATA] dial.
- ⑤ Move the cursor to the value field, then set the value with the [DATA] dial.

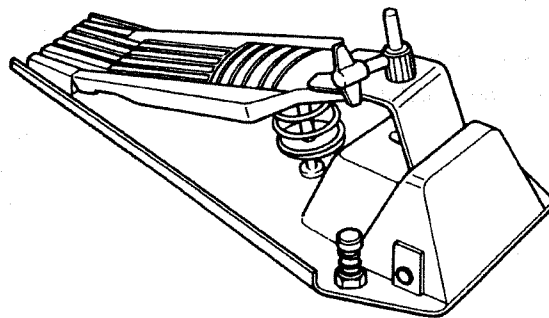

FD-7

* When using an FD-7, execute Hi-hat Control Pedal Initialization.

▶ P. 132

Pedal Parameters include the following:

● Control Mode : CtrlMode

```
[P25]HiHat PEDAL  
CtrlMode= HiHat2
```

The Control Mode determines how the Hi-hat Control Pedal works or what sound parameter will be controlled.

If the Control Mode is set to OFF, the sound will not be affected by any pedal action. MIDI Control Change messages will not be output either.

Hi-hat 1 : HiHat.1

Both Layer and Decay of the two Instruments (assigned to **one** Note Number in the Instrument Section) can be controlled at the same time. Depending on how far you depress the Hi-hat Control Pedal, the volume balance of the two Instruments changes, thus changing the decay.

For example, if Open Hi-hat is assigned to Sound 1 and Closed Hi-hat to Sound 2 of a particular Note Number, selecting Hi-hat mode 1 will automatically choose Hi-hat sounds from Open to Closed in sequence (crossfade), thereby creating a realistic Hi-hat performance.

Hi-hat 2 : HiHat.2

The Instruments assigned to **two** Note Numbers in the Instrument Section can be switched by using the Hi-hat Pedal.

If you depress the Hi-hat Control Pedal a little and hit the pad, the sound selected with "Assign" will be played. If you depress the Hi-hat Control Pedal farther and hit the pad, the sound of the Note Number *which is 4 numbers less* than the Note Number selected in "Assign" will be played. For instance, if Note Number 46 is assigned to the Trigger Signal selected in "Assign", Note Number 42 will be played instead.

- In the HiHat.1 or HiHat.2 mode, the TD-7 can be played simply by pressing the Hi-hat Control Pedal even without hitting the Pads. You can select what sound to be played by assigning the Note Number that corresponds to the Instrument you wish to play. ☞ P. 68
- Generally speaking, when using FD-7, select the HiHat.1 mode for playing the TD-7's internal sound source and select the HiHat.2 mode for playing an external sound module.

* How far you depress the Hi-hat Control Pedal is output as a MIDI Control Change message.

☞ P. 121

* When HiHat.1 is selected, the Layering of Sounds 1 and 2 assigned to the Note Number cannot be controlled by Velocity.

☞ For a detailed explanation of Note Numbers assigned to Trigger Signals, see page 41.

☞ For a detailed explanation of "Assign", refer to page 41.

☞ HiHat.2 may be effectively used when Open Hi-hat and Closed Hi-hat are assigned to two different Note Numbers.

☞ HiHat.2 may be useful when you need two MIDI Notes, Open Hi-hat and Closed Hi-hat.

Pitch : Pitch

The Pitch of a sound can be controlled by how far you depress the Hi-hat Control Pedal.

PITCH+W : Variable range of the pitch is wide. The farther you depress the pedal, the higher the pitch will become.

PITCH+N : Variable range of the pitch is narrow. The farther you depress the pedal, the higher the pitch will become.

PITCH-W : Variable range of the pitch is wide. The farther you depress the pedal, the lower the pitch will become.

PITCH-N : Variable range of the pitch is narrow. The farther you depress the pedal, the lower the pitch will become.

Decay : Decay

The Decay Time can be controlled by how far you depress the Hi-hat Control Pedal.

DECAY+W : Variable range for the Decay Time is wide. The farther you depress the pedal, the longer the Decay Time becomes.

DECAY+N : Variable range for the Decay Time is narrow. The farther you depress the pedal, the longer the Decay Time becomes.

DECAY-W : Variable range for the Decay Time is wide. The farther you depress the pedal, the shorter the Decay Time becomes.

DECAY-N : Variable range for the Decay Time is narrow. The farther you depress the pedal, the shorter the Decay Time becomes.

NUANCE : Nuance

The nuance of a sound can be controlled by the Hi-hat Control Pedal.

The farther you depress the pedal, the higher the Nuance value becomes.

OFF : OFF

The sound will not be affected by depressing the Hi-hat Control Pedal and MIDI Control Change messages will not be output.

☞ Refer to Pitch on page 83.

☞ Refer to Decay on page 83.

☞ Refer to Nuance on page 84.

* You can control the Nuance value only for the sounds marked with "0" at the Nuance section in "Waveform List". (★ P. 144)

● Assign : Assign (TRIG1 - 9/ALL)

```
[P25]HiHat PEDAL  
Assign = TRIG 3
```

The sound of the Trigger Signal selected here can be controlled by the Hi-hat Control Pedal (Control Mode: HiHat 2 P.66). A Trigger Signal is divided into "T" and "R", but both Trigger Signals can be controlled simultaneously. For example, if TRIG 3 is selected, T3 and R3 are both controlled. To control all the Trigger Signals, select ALL.

● Pedal Curve : PdICurve (1 - 4)

```
[P25]HiHat PEDAL  
PdICurve= 4
```

MIDI Control Change messages will be output in response to how far you depress the Hi-hat Control pedal. You can select one of four Pedal Curves that determine how the Control Change value will change.

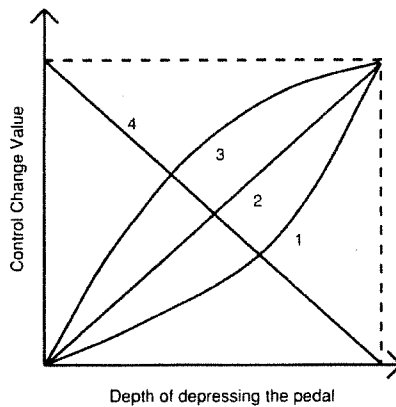

● Note Number : Note # (35 - 93/OFF)

```
[P25]HiHat PEDAL  
Note # = 44:G#2
```

You can play an Instrument just by depressing the Hi-hat Control Pedal. Select the Note Number to which the Instrument you wish to play is assigned. When it is set to OFF, no sound is heard.

- Gate Time : GateTime (0.1 - 4.0 sec)

```
[P25]HiHat PEDAL
GateTime= 4.0s
```

This parameter sets the Gate Time of the Hi-hat Control Pedal sound. This is equivalent to how long the key on a keyboard is held down (from Note ON to Note OFF).

- Velocity Sense Curve : VelCurve (NORMAL1/2/3/4/FIX32/64/96/127)

```
[P25]HiHat PEDAL
VelCurve= Fix127
```

MIDI Note messages can be generated just by depressing the Hi-hat Control Pedal. Here you can select how the velocity value should change according to how hard you depress the pedal. The value changes are the same as for the Trigger Parameters. ⁴⁸ P. 44.

- Sequence Pattern Number : SeqPtn # (1-48/OFF)

```
[P25]HiHat PEDAL
SeqPtn # = 48
```

You can trigger a Sequence Pattern by depressing the Hi-hat Control Pedal. Here you can select the Sequence Pattern Number to be played. 1-24 are User Patterns and 25-48 are Preset Patterns. When the parameter is set to OFF, no pattern data is played.

[8] Program Change Numbers

Changing Patches on the TD-7 will send MIDI Program Change messages to any connected MIDI device. Receiving Program Change messages on the TD-7 will change Patches. However, when OFF is selected, no messages will be sent or received. You can assign a Program Change Number to each Patch.

* OFF/1~128 are valid Program Change Numbers.

- ① Select the Patch Play screen, then press [EDIT].
- ② Move the cursor to PATCH, then press [ENTER].
- If you wish to change Patch Numbers, rotate the [DATA] dial.
- ③ Move the cursor to PGM, then press [ENTER].

```
[P25] PGM CHANGE
PGM Number= 128
```

- ④ Move the cursor to the value field, then set the value with the [DATA] dial.

You can set a Program Number by specifying a number from 1-128, or by using the group, bank, and number (GBN) method. When a keyboard is connected to the TD-7, the GBN method will be more practical.

When you use the GBN method, specify the group, bank and then number. For example, if you specify "A-5-3", Program Change 35 will be transmitted.

		< Group B > Number								< Group A > Number									
		1	2	3	4	5	6	7	8			1	2	3	4	5	6	7	8
Bank	1	65	66	67	68	69	70	71	72	Bank	1	1	2	3	4	5	6	7	8
	2	73	74	75	76	77	78	79	80		2	9	10	11	12	13	14	15	16
	3	81	82	83	84	85	86	87	88		3	17	18	19	20	21	22	23	24
	4	89	90	91	92	93	94	95	96		4	25	26	27	28	29	30	31	32
	5	97	98	99	100	101	102	103	104		5	33	34	35	36	37	38	39	40
	6	105	106	107	108	109	110	111	112		6	41	42	43	44	45	46	47	48
	7	113	114	115	116	117	118	119	120		7	49	50	51	52	53	54	55	56
	8	121	122	123	124	125	126	127	128		8	57	58	59	60	61	62	63	64

- ⑤ Move the cursor to PGM Number.
- ⑥ Select the method, Program Number or GBN, with the [DATA] dial.

```
[P25] PGM CHANGE
PGM GBN   =B-8-8
```

↑ ↑ ↑
 Group Bank Number

- ⑦ Move the cursor to the value field(s), then set the value(s) with the [DATA] dial.

■ Patch Copy Procedure

- ① Select the Patch Play screen, then press [EDIT].
- ② Move the cursor to F-COPY, then press [ENTER].

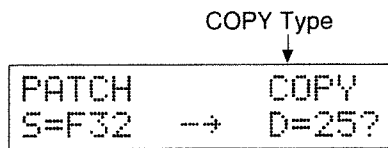

Select Factory Preset or User Patches

- ③ Move the cursor to Copy Type using [◀] and [▶], then select COPY, EXCHANGE, TRIG COPY, or PDL COPY using the [DATA] dial.
- ④ Move the cursor, then select F (Factory Preset Patches) or U (User Patches).
- ⑤ Move the cursor to the Source Patch Number field, select the Patch number with the [DATA] dial.

If you wish to restore all User Patch data to Factory Presets, select F=All using the [DATA] dial.

- ⑥ Move the cursor to the Destination Patch Number field, and select the destination Patch number, with the [DATA] dial.
- ⑦ Press [ENTER].
The screen will respond with Are you sure ?
- ⑧ Press [ENTER] to copy.
To cancel Patch Copy, press [EXIT].

* When you have selected COPY, TRIG COPY, or PDL COPY, you can select a Factory Preset Patch (F1-F32) or a User Patch (U1-U32) as the source Patch. Only a User Patch can be used as a destination.

* When you have selected EXCHANGE, only User Patches (1-32) can be assigned to Pch.

* If you select F=All step ⑤, the destination Patch Number is selected U=All. (You cannot select the destination Patch Number).

3. Global Performance Parameters

The following describes the Global Performance Parameters in the three Performance Sections.

For a detailed explanation of sound settings in the Performance Sections, refer to page 56.

■ How to Set the Global Performance Parameters

- ① Select the Patch Play screen, then press [EDIT].
- ② Move the cursor to GPFM, then press [ENTER].

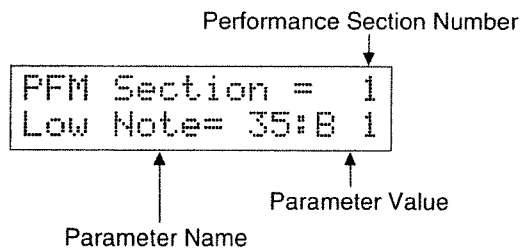

- ③ Move the cursor, then select the Performance Section Number (1-3) where you wish to set the Global Parameters using [DATA] dial.
- ④ Move the cursor to the parameter name field, then select the parameter you wish to edit.
- ⑤ Move the cursor to the parameter value field, then set the value with the [DATA] dial.

Global Performance Parameters include:

● **Key Range Low Note / High Note : Low Note / Hi Note (35(B 1) - 93(A 6))**

```

PFM Section = 1
Low Note = 35:B 1
    
```

↑ ↑
 Note Number Note Name

```

PFM Section = 1
Hi Note = 93:A 6
    
```

↑ ↑
 Note Number Note Name

This parameter determines the range of Note Numbers that each Performance Section can receive. Any Note message between the Key Range Low (the lowest note) and the Key Range Hi (the highest note) can be received. For example, if you set the receive channels of the Performance Sections to the same number and divide the sound range of each section with the Key Range, you can play different Instruments in different sound ranges.

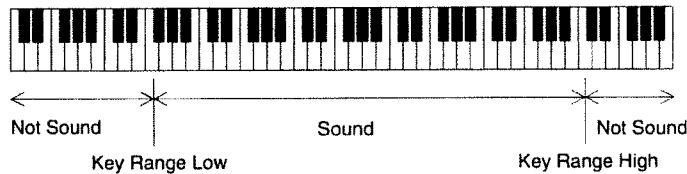

● **Control Change Mode : Ctrl Mode (OFF/Decay/Pitch/Nuance)**

```

PFM Section = 1
CtrlMode = OFF
    
```

Select the parameter (Decay/Pitch/Nuance) to be controlled by MIDI Control Change messages. The Control Change Number on that occasion is the number set with the "Control Change" in the System Parameters. (P. 121) If you do not wish to control any parameter, set it to OFF.

● **Level : Level (0 - 15)**

```

PFM Section = 1
Level = 15
    
```

This parameter sets the volume of each Performance Section. Higher values will increase the volume. When set to 0, no sound will be heard.

* If Key Range Low and Key Range Hi are set to the same Note Number, only that Note Number will be received. Then it will be sound.

* You cannot set Key Range Low to a higher value than Key Range High, or vice versa.

⚠ If you set the MIDI channel of the Trigger Section and the Performance Section to the same number, you can control the parameter you have selected here with the Hi-hat Control Pedal.

* Control Change Messages can be used only 1 type in TD-7. It is selected in "System" (page 121).

■ Key Follow Parameters

Global Performance Parameters also include Key Follow Parameters.

Key Follow Parameters can be used to change the source Parameters (Pitch/Decay/Nuance, Pan) as you move away from the selected Reference Note Number. For example, you can decrease the Decay Time gradually as you play farther away from the selected Reference note, if you have set the Key Follow to Decay.

Key Follow Parameters can be set for each Performance Section.

● Key Follow Reference Note Number : Kfw Note (35 : B 1 - 93 : A 6)

This parameter determines the basic (or Reference) Note Number. Usually it is set to Note Number 60.

```
PfM Section = 1
KfwNote = 60:C 4
```

↑ ↑
Note Number Note Name

● Key Follow Pitch : Kfw Pitch (-990 - +990)

This parameter sets the pitch for each Note Number in one cent steps. When set to +100, you can play using equal temperament.

```
PfM Section = 1
KfwPitch = -990
```

● Key Follow Decay : Kfw Decay (-7 - +7)

```
PfM Section = 1
KfwDecay = -7
```

● Key Follow Nuance : Kfw Nuance (-2 - +2)

```
PfM Section = 1
KfwNuanc = -2
```

● Key Follow Pan : Kfw Pan (-2 - +2)

```
PfM Section = 1
Kfw Pan = -2
```

↳ A "Cent" is a unit of pitch.
One cent is 1/100th of a semi-tone.

↳ "Equal Temperament" is the 12-tone tuning system used throughout the Western world.

About Key Follow Parameters

The value set for each Key Follow parameter is added to (or subtracted from) the source value as the Note Number increases (or decreases) from the Reference Note Number you have set. The higher the Key Follow value, the more the value changes the farther you get from the Reference Note.

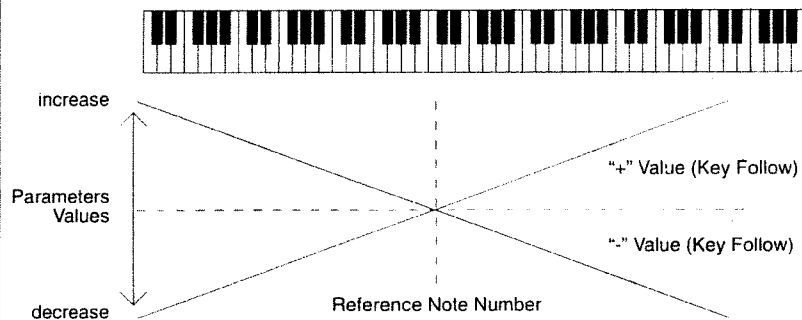

When a Key Follow Parameter is set to a positive (+) value, the source value will increase as the Note Numbers increase. However, when it is set to a negative (-) value, the source value will decrease as the Note Numbers increase. For example, when set to $+1/8$, the value of the parameter will increase by 1 when the Note number increases by 8. When it is set to -2 , the value decreases by 2 when the Note Number increases by one. If you do not wish to cause any change in a source parameter, set this parameter to 0.

Chapter 4

Editing Instrument Sounds

1. Instrument Parameters	78
2. Instrument Copy	89

1. Instrument Parameters

Patch Setting (page 40) allows you to change the pitch of an Instrument (in semitone steps) assigned to a Note Number. However, if you wish further modification, such as making the snare sound softer, you should edit the Instrument Parameters. Doing so allows you to easily create the sounds you desire.

■ How to Set the Instrument Parameters

- ① Press [EDIT].
- ② Move the cursor to INST (using [◀] and [▶]), then press [ENTER].

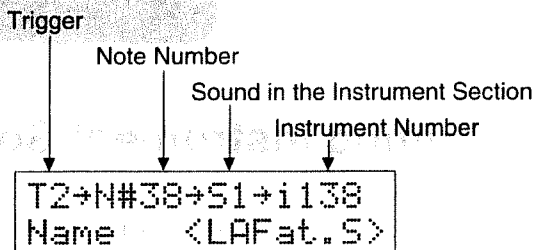

- ③ Select the Instrument Number you wish to edit using the [DATA] dial.
Move the cursor to the Trigger, Note Number or Sound, you can also select the Instrument Number.
- If the selected Instrument has only been assigned to the Performance Section, the screen will respond with:

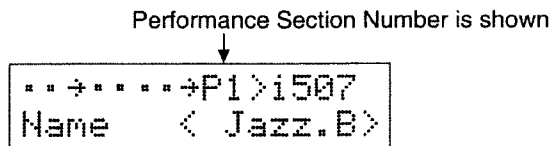

- If the selected Instrument has not been assigned to either the Instrument or Performance Section, the screen will respond with:

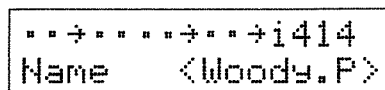

- ④ Move the cursor to the parameter name field, then select a Parameter using the [DATA] dial.

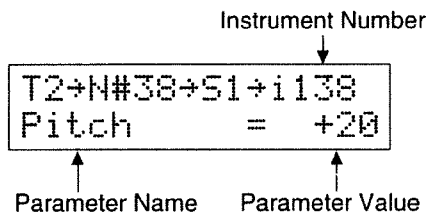

- ⑤ Move the cursor to the parameter value field, then set the value using the [DATA] dial.

* Depending on the patch selected, what appears in the screen will be different. The left screen will be shown, when you select the Patch 25 (Standard kt).

■ How to view the Instrument Parameter Screen

- When the **Waveform** parameter has been selected, move the cursor to the **Number** and **Extension**, then change the value with the [DATA] dial.

```
T2→N#38→S1→i138
Waveform = 25.S
```

↑ ↑
Number Extension

- If you move the cursor to the **Note Number** and press [ENTER], the **Note Number** indication will change to **Note Name**. Pressing [ENTER] will alternately select **Note Number** and **Note Name**.

Note Number
↓

```
T2→N#38→S1→i138
Name <LAFat.S>
```

[ENTER] ↑ ↓ [ENTER]

Note Name
↓

```
T2→nD 2→S1→i138
Name <LAFat.S>
```

- If an **Instrument** is used in more than one place (**Trigger/Note Number/Sound 1/Sound 2** or **Performance Section**) a (*) mark will appear to the right of the **Instrument Number**.

A mark is shown
↓

```
T5→N#48→S1→i265*
Name <Real2.T>
```

If so, you can monitor what Pads (or Note Numbers) the Instrument is assigned to.

Move the cursor to the Instrument Number (1512), then press [ENTER]. Pressing [ENTER] will select the following displays in sequence:

```
R1+N#35+S2+i512*
Name < Off.E>
```

[ENTER]

```
T1+N#36+S2+i512*
Name < Off.E>
```

[ENTER]

```
..+N#37+S2+i512*
Name < Off.E>
```

[ENTER]

```
T2+N#38+S2+i512*
Name < Off.E>
```

[ENTER]

```
R5+N#39+S2+i512*
Name < Off.E>
```

- If you hit a pad while the Instrument Parameter setting screen is displayed, it will change to the screen of the pad you hit. For example, even if the Trigger Signal "T5" screen is currently displayed, hitting the "T2" pad will select the "T2" screen. Similarly, if the MIDI Note message of a certain Note Number is received, the corresponding Note Number screen will be displayed.

```
T5+N#48+S1+i265*
Name <Real2.T>
```

```
T2+N#38+S1+i138*
Name <LAFat.S>
```

- If you depress the Hi-hat Control Pedal while the Instrument Parameter setting screen is displayed, it will change to the screen assigned to the Pedal.

```
T2+N#38+S1+i138*
Name <LAFat.S>
```

```
Pd+N#44+S1+i304*
Name <AcoPH.H>
```

■ Jump Function

The Jump function allows you to instantaneously move from the Instrument Parameter screen to the Trigger Parameter/Pedal Parameter/Instrument Section/Performance Section screen.

- ① Move the cursor to the parameter you wish to jump to.

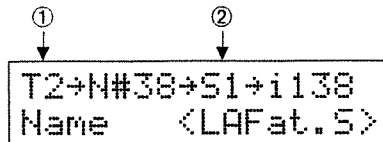

```
T2→N#38→S1→i138
Name <LAFat.5>
```

When the cursor is positioned at ①, you can move to the Trigger Parameter or Pedal Parameter screen. With the cursor at position ②, you can move to the Instrument Section or Performance Section screen.

- ② When the cursor is positioned at ①, press [ENTER].

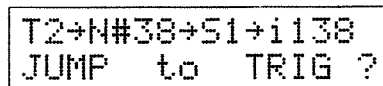

```
T2→N#38→S1→i138
JUMP to TRIG ?
```

When the cursor is positioned at ②, press [ENTER].

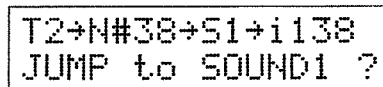

```
T2→N#38→S1→i138
JUMP to SOUND1 ?
```

- ③ Press [ENTER] again to jump.
To cancel the Jump mode, press [EXIT].

The following parameters can be set for each of the TD-7's 512 Instrument sounds.

● Instrument Name : Name

```
T2→N#38→S1→i138
Name <LAFat.S>
```

Each Instrument can be named using up to 6 characters; 5 letters and one extension. You should put a "." (full-stop) between the 5 letters and the extension. The extension is a character that represents the category of the Instrument.

● Waveform : Waveform

```
T2→N#38→S1→i138
Waveform = 25.S
```

Select the waveform that the Instrument is made from. There are 256 different waveforms. ^{see} P. 144

01.K - 43.K Waveforms for Kick Drums.

01.S - 59.S Waveforms for Snare Drums.

01.T - 36.T Waveforms for Tom-Toms.

01.H - 08.H Waveforms for Hi-hat Cymbals.

01.C - 08.C Waveforms for Ride/Crash Cymbals.

01.P - 52.P Waveforms for Percussion sounds.

01.M - 11.M Waveforms for Mallet Instruments.

01.E - 34.E Waveforms for Effect Sounds.

01.B - 05.B Waveforms for Bass Guitars.

- Pitch : Pitch (-4800 – +4800 cents; in 10 cent steps)

```
T2+N#38+S1+i138
Pitch      = +20
```

This parameter adjusts the pitch of the Instrument. The value can be changed in 10 cent steps. Higher values raise the pitch.

- Decay : Decay (-31 – +31)

```
T2+N#38+S1+i138
Decay     = -31
```

This parameter adjusts the Decay Time of the Instrument. Higher values increase the Decay Time.

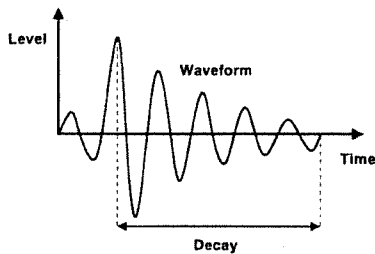

- Panning : Pan (L7 - C - R7/RND)

```
T2+N#38+S1+i138
Pan       = R 7
```

This parameter sets the panning (stereo positioning) of the Instrument. 15 positions are available.

When set to RND, stereo positioning will change every sounds.

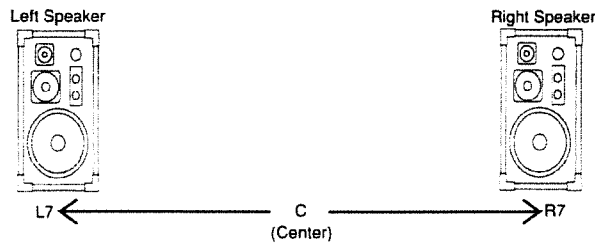

* For some Instruments, the pitch cannot be changed beyond a certain point.

● Nuance : Nuance (-7 - +7)

```
T2→N#38→S1+i138
Nuance    =    +7
```

For Instruments Nuance marked with "O" in the "Waveform List" (page 144), the sound will be subtly altered by the Nuance setting.

With drum type sounds, the harmonic content will be emphasized by lower Nuance values, simulating the sounds created by striking a drum near the rim (a). When the Nuance parameter is set to a higher value, the sound will simulate that of a drum being struck in the center of the head (b).

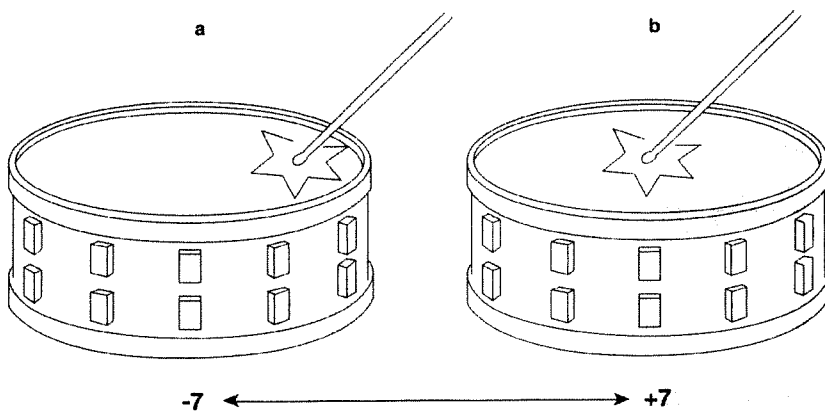

With cymbal type sounds, lower Nuance values will simulate the sounds created by striking a cymbal near the edge (a), while higher values will simulate the sounds of a cymbal being struck near the center (b).

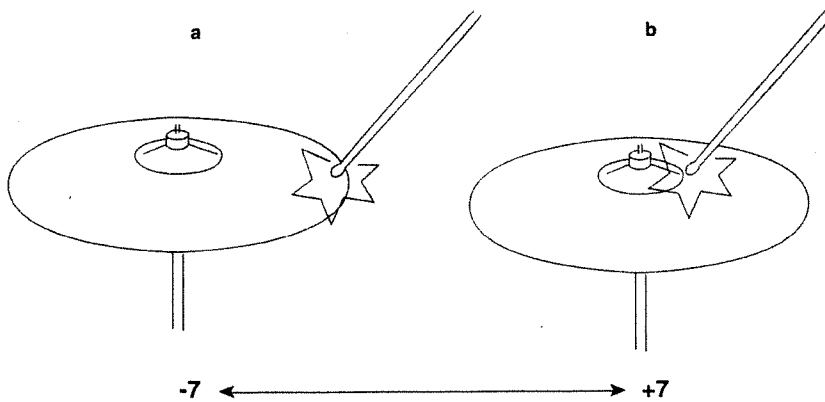

With mallet type sounds, lower Nuance values will simulate the sounds created by playing the Instrument with a hard (wood or rubber) mallet, while higher values will simulate the sounds created by playing the Instrument with a soft (wool or felt) mallet.

↔ "Mallet" are special sticks used for playing vibraphones, marimbas, etc.

● Brilliance : Brilliance (0 - 15)

```
T2+N#38+S1+i138  
Brilliance= 15
```

This parameter emphasizes the harmonic content of a sound. When set to a higher value, the higher frequencies will be emphasized. When set to 0, they are not emphasized at all.

● Attack Damp : AttackDamp (0 - 15)

```
T2+N#38+S1+i138  
AttackDamp= 15
```

This parameter changes the attack of the sound. Higher values soften the attack.

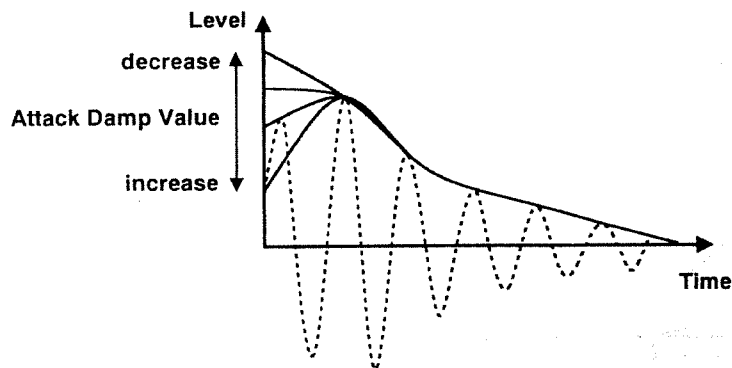

● Dynamic Pitch Bend : DynaPtBend (-7 - +7)

```
T2+N#38+S1+i138  
DynaPtBend= -7
```

This parameter determines the amount of pitch change (pitch bend range) caused by hitting the pads. The pitch increases when Dynamic Pitch Bend is set to a positive value, but decreases when the value is negative. Higher values will cause more drastic pitch change. When set to 0, the pitch does not change at all.

● Dynamic Pitch Bend Time : Bend Time (0 - 31)

```
T2+N#38+S1+i138  
Bend Time = 31
```

Bend Time sets the duration of the Dynamic Pitch Bend. Higher values increase the Bend Time.

● Polyphony : (Poly / Mono)

```
T2+N#38+S1+i138  
Polyphony = Poly
```

This selects either Poly or Mono mode for playing one Instrument.

Poly

In the poly mode, the sounds of one Instrument overlap with one another. For example, if you play a ride cymbal sound, which has a long decay, the decay of individual strokes overlap with one another, creating a realistic effect.

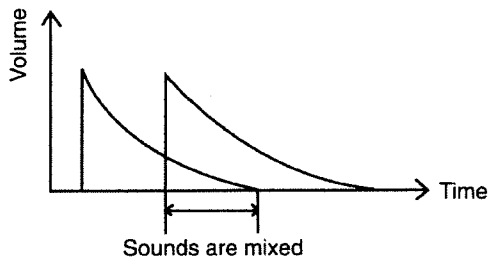

MONO

In the mono mode, the sound of an Instrument is cutoff whenever another sound is played.

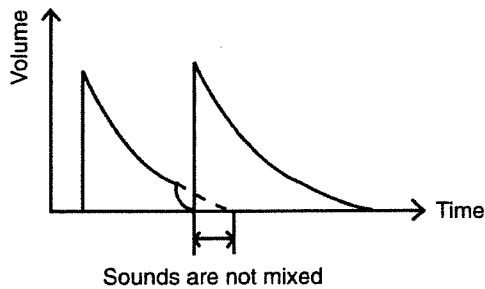

● Assign Group : AssignGroup (Exc1 - 31/OFF)

```
T2+N#38+S1+i138  
AssignGroup=Exc31
```

The Instruments assigned to the same Assign Group cannot play at the same time. For example, when you are playing an acoustic drum set, the open Hi-hat and closed Hi-hat sounds cannot occur simultaneously. That is, you can assign Instruments that do not normally sound together to the same Assign Group.

Instruments that should be assigned to the same Assign Group are: Short Whistle and Long Whistle, Short Guiro and Long Guiro, Mute Cuica and Open Cuica, Mute Triangle and Open Triangle, Mute Surdo and Open Surdo, Mute Pandiero and Open Pandiero, etc.

If you wish to play an Instrument at the same time with the others, set the Assign Group to OFF.

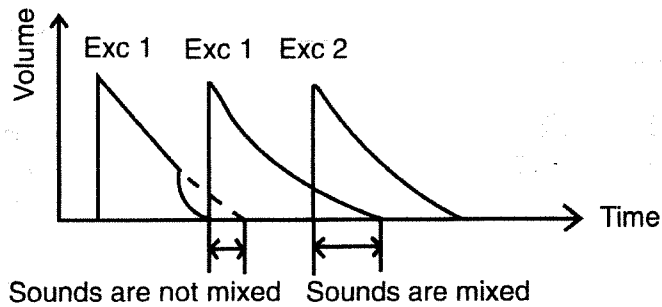

● Output Level : Out Level (0 - 15)

```
T2+N#38+S1+i138
Out Level= 15
```

This parameter sets the volume of an Instrument output through the Stereo Outs. Higher values increase the volume. At 0, no sound is output.

● Send 1 Level : Send1Level (0 - 15)

```
T2+N#38+S1+i138
Send1Level= 15
```

This parameter sets the level of an Instrument signal sent to Effect 1 and Individual Output 1. Higher values increase the signal level. At 0, no signal is output.

● Send 2 Level : Send2Level (0 - 15)

```
T2+N#38+S1+i138
Send2Level= 15
```

This parameter sets the level of an Instrument signal sent to Effect 2 and Individual Output 2. Higher values increase the signal level. At 0, no signal is output.

* Signals to be sent to Send 1 should be selected from:

- ① Input to Effect 1
- ② Output from Individual Output 1

Either can be selected in Sound Setup. **P. 129**

* Signals to be sent to Send 2 should be selected from:

- ① Input to Effect 2
- ② Output from Individual 2

Either can be selected in Sound Setup. **P. 129**

■ Instrument Copy Procedure

- ① Select the Patch Play screen, then press [EDIT].

```
(EDIT)PATCH|INST
P-CPY|I-CPY|GPFM
```

- ② Move the cursor to I-CPY, then press [ENTER].

Select COPY or EXCHANGE
↓

```
INSTRUMENT COPY
S=F511 -> D=512?
```

↑ ↑
Instrument Number

Select Preset or User Instruments

- ③ Move the cursor to "COPY or EXCHANGE", then select either with the [DATA] dial.
- ④ Move the cursor, then select F (Factory Preset Instruments) or U (User Instruments)
- ⑤ Move the cursor to the source number field, then select the source Instrument Number with the [DATA] dial.

If you wish to restore all User Instrument data to Factory Presets, select F=All using the [DATA] dial.

- ⑥ Move the cursor to the destination number field, then select the destination Instrument Number with the [DATA] dial.
- ⑦ Press [ENTER].
The screen responds with Are you sure ?
- ⑧ Press [ENTER] to copy.
To cancel copying, press [EXIT].

* When you have selected COPY, you can select a Factory Preset Instrument (F1-F512) or User Instruments (U1-U512) as the source Instrument. Only a User Instrument can be used as a destination.

* When you have selected EXCHANGE, only User Instruments can be assigned to Inst.

* If you select F=All in step ⑤, the destination Instrument Number is selected; U=All. (You cannot select the destination Instrument Number).

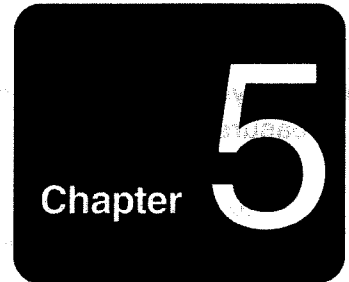

Phrase Sequencer

1.How to Record Sequence Data	92
2.Phrase Sequencer	95
3.Tempo, Metronome, Available Memory and Synchronized Playback	103

1. How to Record Sequence Data

The TD-7's recording method is Loop Recording in Real-time. That is, as you play, new data is added to your sequence which is playing over and over again. You'll find it very easy!

Before beginning, specify the Sequence Pattern Number and the number of measures you are going to create.

■ Specifying the Sequence Pattern Number and the number of measures :

- ① Select the Patch Play screen, then press [SEQUENCER].
The screen displays the Sequencer menu.

```
(SEQ) PTN|TEMPO
SYNCL|AVAIL|METRO
```

- ② Using [◀] and [▶], move the cursor to PTN and then press [ENTER].

```
PTN    REC/PLAY
CLEAR|TYPE|COPY
```

- ③ Move the cursor to CLEAR, then press [ENTER].

Sequence Pattern Number

```
CLEAR PTN[01] ■
Clear All= OK ?
```

- ④ Using the [DATA] dial, specify the Sequence Pattern Number to be recorded.

◀ Patch Play Screen

▶ P. 17

* Please note that pressing [ENTER] in this screen will erase the sequence data.

* Sequence Pattern Numbers 25 - 48 are Preset Patterns and cannot be used for recording.

- ⑤ Move the cursor to **Clear All**, then select **Measure** using the **[DATA]** dial. Move the cursor to the **Measure Number**, change the value to the desired number with the **[DATA]** dial and then press **[ENTER]**.

```
CLEAR PTN[23] ■
Measure = 2
```

Number of measures

[ENTER]

```
Are you sure ?
Measure = 8?
```

- ⑥ The display responds with **Are you sure ?** If you wish to enter the new value, press **[ENTER]**. Press **[EXIT]** to cancel.

■ Begin recording:

- ① Press **[ENTER]** to select screen ② in the previous procedure.

```
PTN REC/PLAY
CLEAR TYPE/COPY
```

- ② Move the cursor to **REC/PLAY**, then press **[ENTER]**.

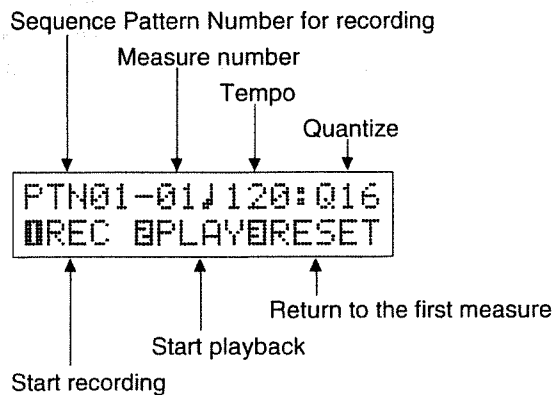

⊕ If any data exists in the Sequence Pattern you have selected, it will be played back here.

⊕ If you change the measure number or beat previously set, ? will be displayed to the right of the new value.

⊕ If screen ② does not appear when you press **[ENTER]**, follow steps ① and ②) in the previous procedure "■ Specifying the Sequence Pattern Number and the number of measures".

- ③ Move the cursor to **TEMPO**, then set the tempo with the **[DATA]** dial.
- ④ Move the cursor to **Quantize**, then set the Quantize value with the **[DATA]** dial.
- ⑤ Press **[1]** (**[SYSTEM]**) to select the record stand-by mode.

```

REC[01-01] J=120
Q=64 BERAEBSTOP

```

The LED of the **[SEQUENCER]** button flashes at the current tempo. Play the pads (or a keyboard) in time with the flashing LED or the unit's metronome. What you play will be recorded in real-time.

During Loop recording, the measures in your sequence (or Loop) will play over and over again. For example, if you are recording a two bar sequence, those two bars will be played repeatedly. During recording, what you play is immediately added to what you played previously. In this way, you can build up your sequence until it's complete.

- ⑥ When you finish, press **[3]** (**[EDIT]**) to stop recording.

To playback the sequence data, press **[2]** (**[SEQUENCER]**).

You can also play back the sequence data by playing the pads. The parameters for this function are shown on page 44.

When the TD-7 receives a MIDI Note On message from an external device, it starts playing back the sequence data. The Note On message is sent on the MIDI channel set in the Trigger (Trigger Transmit Channel). ☞ P. 115

You can start playing a sequence pattern by pressing the Hi-hat Control Pedal (FD-7:option). How to set the sequence Pattern to be played is explained on page 69.

⇄ "Quantize" means correcting timing inaccuracy in performance.

* To change tempo or quantize values during recording, move the cursor to the relevant parameter, then change the value using the **[DATA]** dial. However, when the Sync Mode (☞ P. 105) is set to **MIDI**, you cannot change tempo values. In this mode, the display will show **J=MIDI** and the TD-7 starts recording only when it receives MIDI timing clocks from an external MIDI device.

2. Phrase Sequencer

The TD-7 is equipped with a sequencer that allows you to create original rhythms and bass patterns. The **Sequencer** is the unit that records pad (or keyboard) performance data and plays it back. The Sequencer can also be synchronized to another MIDI device.

- The TD-7 contains 24 different Preset Patterns and can store up to 24 User Patterns. Original Sequence Patterns are stored in User Patterns; the contents of the Preset Patterns cannot be changed.
- Pattern Numbers 1 - 24 are User Patterns, and Pattern Numbers 25 - 48 are Preset Patterns.

The TD-7's four Sections can be played. The four sections are: the **Instrument Section**, **Performance Section 1**, **Performance Section 2** and **Performance Section 3**.

Each of the 4 Sections is assigned its own MIDI channel. Therefore, what can be recorded/played back must be data that uses one of these same 4 channels, and it will be recorded/played back as belonging to the Section that is assigned the same channel as the channel the performance data traveled on. This is true whether it is performance data generated by hitting the pads, or that arriving over MIDI IN. However, The MIDI channel is not recorded in the Phrase Sequencer. Sequence data is distinguished by the section name.

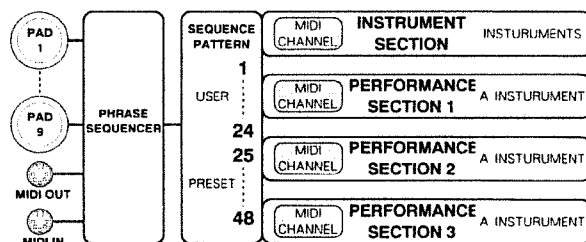

- Only Note On and Control Change (of the Hi-hat Control Pedal), messages are recorded in the Phrase Sequencer. No other messages are recorded. That is, only the data set with the "SYSTEM" parameters (see P. 121) is recorded.
- Though the MIDI channel is not recorded in the Phrase Sequencer, sequence data can be distinguished by the section name. MIDI messages are output to external devices on the MIDI channel set in the Instrument or Performance section. For example, if channel 2 is set in Performance section 1, sequence data of Performance section 1 will be transmitted on channel 2.

* The amount of data that can be recorded in the TD-7's sequencer is limited. That is, when you have created Sequence Patterns with a lot of data, you may not have room for 24 different patterns. Check the amount of memory remaining using Available Memory (+ P. 105)

⇒ For a detailed explanation about MIDI channel settings, refer to page 115, 116.

* The Phrase Sequencer does not record Note Off messages (see P. 111). When the sequencer is playing back data, a Note Off message is output immediately after a Note On.

[1] Recording and playback of Sequence Patterns

To record or play back Sequence Patterns, select **PTH** in the Sequencer screen.

```
(SEQ) PTH|TEMPO
SYNCAVAIL|METRO
```

When **PTH** is selected, the following menu will be displayed. This is called the **Pattern Creating** Screen.

```
PTH REC/PLAY
CLEAR|TYPE|COPY
```

To record or play back, select **REC/PLAY** in the Pattern Creating screen.

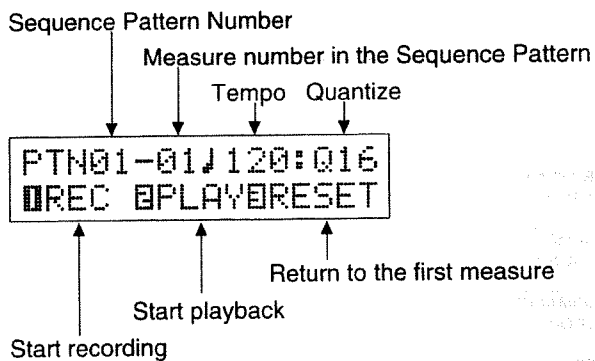

Pressing **[1]** (**SYSTEM**) will select the record stand-by mode.

Pressing **[2]** (**SEQUENCER**) will start playback.

Pressing **[3]** (**EDIT**) will reset to the first measure of data.

Move the cursor to the appropriate parameter, then change the value with the **[DATA]** dial.

- **Sequence Pattern Number (1 - 24)**

Select the Pattern Number to be recorded or played.

- **Measure Number (1 - 16)**

This indicates the measure number in a Sequence Pattern. You can select the measure number from which to start recording or playback.

- **Tempo (24 - 260 bpm)**

This sets the tempo of the sequencer.

Sequencer Screen

P. 34

* For recording, Preset Patterns (25 - 48) cannot be used.

● **Quantize (1/8, 1/12, 1/16, 1/24, 1/32, 1/48, 1/64, HIGH(1/96))**

The quantize function corrects timing inaccuracies that occur during recording. For instance, if you set it to 1/16, all the sixteenth notes in your sequence will fall precisely on the sixteenth note divisions in each measure. [Notes of longer duration will fall on their respective divisions as well.] Normally, this setting should reflect the smallest note value in your sequence. When set to HIGH, no quantization will be applied to what you play.

Example: 1/16 resolution

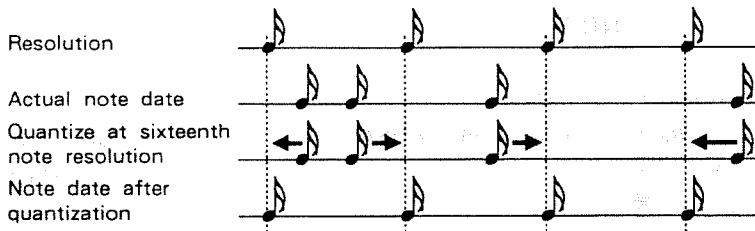

■ **To edit the recorded data**

If you wish, you can erase your work and re-record the sequence. You can also erase individual Instruments or Note Numbers instead of re-recording the entire sequence.

```
REC [01-01] = 120
Q=16 ERASE STOP
```

In the above recording screen, pressing [2] (SEQUENCER) will cause ERASE to flash.

If you play a pad (or a note on the keyboard) while ERASE is flashing, the sequence data of the Instrument assigned to the relevant Pad (or Note Number) will be erased.

If you press [2] (SEQUENCER) again while ERASE is flashing, the sequencer will return to the record mode.

[2] Setting Beat and Number of Measure and Erasing Sequence Data

- ① In the Sequencer screen, move the cursor to **PTN** and then press [ENTER].
This will select the Pattern Creating screen.

```
PTN      REC/PLAY
CLEAR|  TYPE|COPY
```

- ② Move the cursor to **CLEAR**, then press [ENTER].

Sequence Pattern Number to be edited

Whether sequence data exists or not

```
CLEAR PTN[23] ■
Clear All= OK ?
```

Name of the function to be used

- ③ Move the cursor using [◀] and [▶], then set the Sequence Pattern Number to be edited and the function to be used.

The following functions are available:

Clear All	Erases the entire Sequence Pattern.
Measure	Sets the number of measures in the Sequence Pattern (1 - 16).
Beat	Sets the beat of the Sequence Pattern (2/4, 3/4, 4/4, 5/4, 6/4, 7/4.)

↳ Sequencer Screen

↳ P. 34

↳ If data exists in the Sequence Pattern Number, ■ is displayed. If no data exists, □ is displayed.

■ To erase Sequence Data

- ④ Select **Clear All** using the [DATA] dial, then press [ENTER].

The screen responds with **Are you sure?**

The selected Sequence Pattern is played so that you can hear it one more time.

- ⑤ Press [ENTER] again to erase the Sequence Pattern.

To leave this mode, press [EXIT].

If no data exists in the Sequence Pattern you have selected, the following screen will appear:

When no sequence data exists

CLEAR PTN[23] □
Clear All= OK ?

When the sequence data is erased, the measure number and beat set in the following section will be the new values. [The factory default setting for Measure number is "2", and the default for Beat is "4/4"]

■ To set Measure Number and Beat

- ④ Select **Measure** or **Beat**, using the [DATA] dial.

CLEAR PTN[23] ■
Measure = 12

CLEAR PTN[23] ■
Beat = 4/4

- ⑤ Move the cursor using [◀] and [▶], then set the value with the [DATA] dial.

When the preprogrammed measure number or beat value is edited, ? will appear to the right of the value.

CLEAR PTN[23] ■
Measure = 10?

- ⑥ Press [ENTER]. The screen responds with **Are you sure?**

The selected Sequence Pattern is played so that you can hear it one more time.

- ⑦ Press [ENTER] to enter the value. To cancel the procedure, press [EXIT].

* If you have shortened the number of measures or the beat, the extra data is erased. If you have made them longer, all the previous data will be retained.

[3] Selecting a Performance Type

The Sequencer contains several different Performance Types:

Set to A, the level of Sequence Pattern is determined depend on how hard you play the pad.

Set to B, sequence Pattern will play the recorded level regardless of the strength you play the pad.

Loop A - Loop B Hitting a pad will start playback. The pattern will play repeatedly until you hit the pad again.

Once A - Once B Hitting a pad will start playback. The Sequence Pattern will be played once. Hitting the same pad again while the Sequence Pattern is playing will re-trigger the pattern from the beginning.

Tap1 A - Tap4 A Sequence data advances one step every time a pad is hit. When set to TAP 2 Tap1 B - Tap4 B - TAP4, hitting the pad after a certain "interval" will reset the Sequence Pattern, playing it from the beginning. The "interval" is longer when the Tap number is higher (2 - 4).

- You can control a Sequencer Pattern by playing a note on an external MIDI keyboard (in the same way as hitting a pad). To do so, play the key (Note Number) assigned to the pad (P. 42).

■ How to set the Sequencer Performance Type

- ① In the Sequencer screen, move the cursor to PTH and then press [ENTER]. The Pattern Creating Screen is selected.

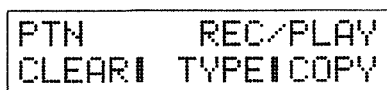

- ② Move the cursor to TYPE, then press [ENTER].

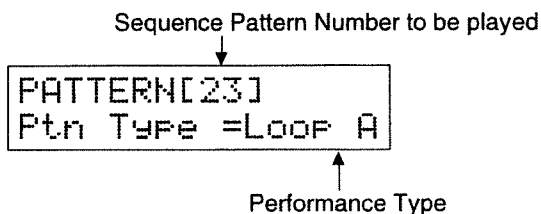

- ③ Move the cursor using [◀] and [▶], then select the Sequence Pattern Number to be played using the [DATA] dial.
- ④ Move the cursor using [◀] and [▶], then select the Performance Type using the [DATA] dial.

* All Sequence Patterns are created with the "Loop" recording method. In the Playback mode, however, data is played with the selected Performance Type.

* You cannot play "Loop" Sequence Patterns and "Once" Sequence Patterns at the same time. However, both Sequence Patterns set at "Once (Loop)" and "Tap1~4" can be played simultaneously.

↔ Sequencer Screen
P. 34

[4] Copying Sequence Pattern

You can copy a Sequencer Pattern to a different Sequence Pattern Number. If you wish to edit the Pattern without losing the original data, copy it to a different Sequence Pattern number before editing it. The copy function also allows you to shift the pitch of data (in semi-tone steps) to make transposition easier.

You can use one of two copying methods:

- **COPY** This method copies sequence data while changing the pitch at the same time (if desired). It may be effectively used for changing the key of melodic sequence data (bass sequences, for example). 24 levels, from -12 to +12, are available. A setting of +12 raises the pitch by 1 octave. At 0, the pitch of data is unchanged.

```
PTN  TRANS  COPY  
S=14  ±0  ÷  D=23?
```

↑ ↑ ↑
Source Sequence Pattern Number The amount of pitch shift Destination Sequence Pattern Number

- **EXCHANGE** This method exchanges data of one Sequence Pattern with that of another.

```
PATTERN EXCHANGE  
PTN15 ←→ PTN23?
```

↑ ↑
Sequence Pattern Numbers to be exchanged

■ Procedure for copying Sequence Pattern

- ① Move the cursor to **PTN**, then press **[ENTER]**.

The Pattern Creating Screen is selected.

```
PTN      REC/PLAY
CLEARI  TYPE|COPY
```

- ② Move the cursor to **COPY**, then press **[ENTER]**.

COPY or EXCHANGE

```
PTN TRANS COPY
S=14 ±0 ÷ D=23?
```

- ③ Move the cursor to **COPY**, then select **COPY** or **EXCHANGE** using the **[DATA]** dial.

- ④ Move the cursor using **[◀]** and **[▶]**, then set the Pattern Number and Pitch using the **[DATA]** dial.

- ⑤ Press **[ENTER]**.

The screen responds with **Are you sure ?**

● The Sequence Pattern that is flashing in the screen is played back.

- ⑥ Press **[ENTER]** to copy.

Press **[EXIT]** to cancel.

☛ Sequencer Screen

☛ P. 34

* When **COPY** is selected, Sequence Patterns 1 - 48 are available as source patterns, while only User Patterns 1 - 24 are available as destination patterns.

* When **EXCHANGE** is selected, only User Patterns 1 - 24 are available as both source and destination patterns.

Metronome parameters are:

● **Interval (1/4, 1/8, 1/12)**

This parameter sets the interval (beat) for the metronome. When the TYPE is set to **Click**, the first note of the measure will sound higher in pitch. When set to **Voice**, the voice changes depending on the metronome setting.

● **Mode (OFF/Rec/Empty/Play)**

This parameter determines how the metronome should be played:

OFF: OFF	No metronome sound is heard.
Recording: REC	The metronome is heard during recording.
Empty: EMPTY	The metronome is heard only when no performance data exists in the selected Sequence Pattern.
Play: PLAY	The metronome is heard during recording and playback. This mode may, therefore, be used for practice. For instance, you could make a blank Sequence Pattern (with no data), then play it back by playing the pads. By doing so, only the metronome will be heard. You can then practice playing along with the metronome.

● **Count in (OFF/1, 2)**

A metronome "count-in" occurs before recording begins (after the Record button (I) is pressed). When set to **OFF**, recording starts immediately when the Record button is pressed. When set to **1** or **2**, recording begins after a one or two measure count-in.

● **Type (Click/Voice/CowBl/WdBk/80Mrc)**

This parameter determines which sound - click, human voice, cowbell, woodblock, or TR-808 maracas - will be heard during the metronome count-in.

● **Level (1 - 16)**

This parameter sets the volume of the metronome. Higher values increase the volume.

[3] Available Memory

The TD-7 stores sequence performance data in internal memory. The capacity of the **Memory IC** is limited, and the TD-7 can indicate how much memory is still available (**Available Memory**). When 0% is shown, no further recording is possible.

- ① In the Sequencer screen, move the cursor to **AVAIL**, and then press **[ENTER]**.

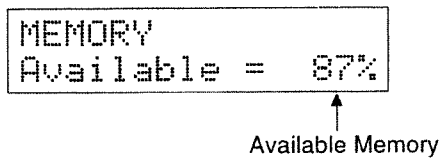

[4] Synchronized Playback

The TD-7's Phrase Sequencer can synchronize to an external MIDI device.

- ① In the Sequencer screen, move the cursor to **SYNC** and then press **[ENTER]**.

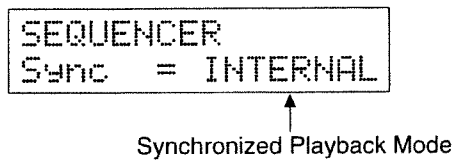

- ② Select a Synchronized Playback Mode using the **[DATA]** dial.

INTERNAL	An external MIDI device synchronizes to the TD-7's MIDI clock signals.
MIDI	The TD-7 synchronizes to an external device's MIDI clock signals.

When set to **INTERNAL**, the TD-7 sends MIDI Timing Clocks (F8) through MIDI OUT, but does not send Start (FA), Continue (FB) or Stop (FC) signals.

When set to **MIDI**, the TD-7 does not send MIDI Timing Clocks (F8) through MIDI OUT. The TD-7 receives Timing Clocks from an external MIDI device through MIDI IN and plays back the performance data accordingly. Playing the pads (or Keyboard) or receiving MIDI Note ON will start playback. Start (FA), Continue (FB) or Stop (FC) signals will be ignored.

⇨ Sequencer Screen
P. 34

* When set to **MIDI**, you can not change tempo values. In this mode, the display will show **J = mid.**

$$4500000 = 4000000 + 500000$$

$$4500000 - 4000000 = 500000$$

$$500000 = 500000$$

$$4500000 = 4000000 + 500000$$

Chapter 6

System Setting

1.MIDI	108
2.Setting the Interface Mode	123
3.Using the Footswitch and Sound-on-Sound	124
4.The Sound Setup	129
5.Initialization	132

System parameters include those related to the entire system of the TD-7, such as MIDI, Footswitches, Sound-on-Sound, Effects Output, Individual Output, Initialization, etc.

1. MIDI

MIDI (pronounced middy) stands for Musical Instrument Digital Interface. MIDI is a world-wide standard that allows musical instruments and computers to exchange musical data. Most electronic musical instruments sold today are MIDI compatible. MIDI compatible devices have MIDI connectors which are used to physically link instruments (using special cables). MIDI does not transmit the sound of an instrument, but rather 'messages' in digital form that tell the receiving instrument to "do something". These are known as MIDI messages.

[1] MIDI Messages

MIDI messages are sent or received through three types of MIDI connectors.

■ About MIDI Connectors

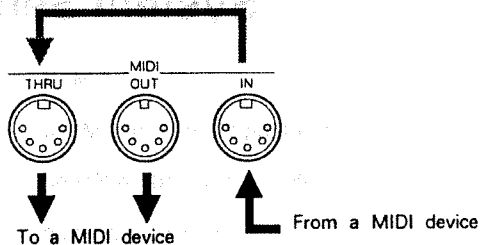

MIDI IN : This connector receives MIDI messages from an external MIDI device.

MIDI OUT : This connector transmits outgoing MIDI messages to other devices.

MIDI THRU : MIDI messages received at MIDI IN are re-transmitted by the MIDI THRU connector. (This connector does not transmit messages that originate inside the unit itself.)

● The TD-7 does not feature the MIDI THRU connector.

* Technically speaking, any number of MIDI devices can be connected using MIDI THRU connectors. The practical limit, however, is 5 units. This is because delay or deterioration of the MIDI signals will occur as the signal path becomes longer and longer.

■ MIDI Channels

MIDI allows you to transmit and receive many different MIDI messages using only one cable. This is made possible because MIDI includes 16 different channels.

MIDI channels are easy to understand if we use the analogy of television broadcasting. Many television programs are broadcast from many TV stations and your TV antenna receives them all.

By setting your television to a specific channel, you can watch only the desired program. The same idea applies to MIDI channels. The master (transmitting) device is somewhat like the broadcast station, and the slave (receiving) device is like a television receiver. The MIDI messages carried by the MIDI cable are like the programs that are transmitted from the broadcast stations.

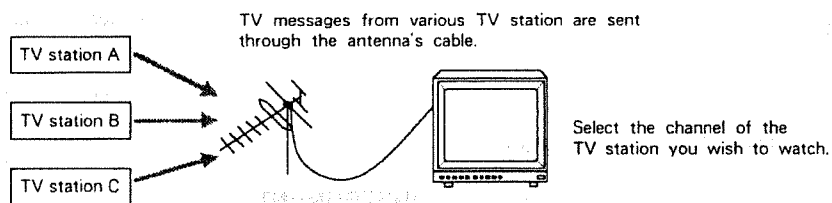

MIDI performance information is transmitted from the master device to the slave when the MIDI channels on both devices match (i.e., are set to the same number). When the MIDI channels are set as follows, only sound module B will respond when the keyboard is played (sound module A does not respond). This happens because only sound module B is set to the same channel number as the keyboard, while that of sound module A is set to a different number.

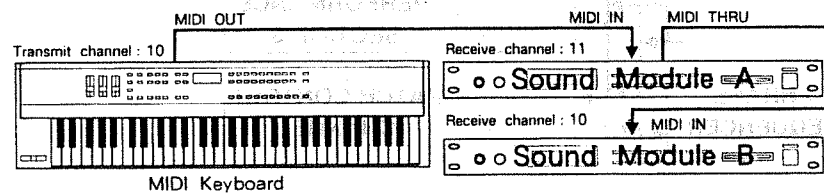

The TD-7 can recognize MIDI messages of more than one channel at a time. It has four channels for the Performance Parts (sections) and one for Program Changes (a channel for receiving and transmitting Patch Control). P. 116

Because the TD-7 can recognize MIDI messages on four channels at once, it can be used as a 4-part multi-timbral sound module. That is, by setting different channels for the **Instrument Section** and **Performance Sections (1, 2 and 3)**, you can create Multi-part performances using MIDI data.

The **Instrument Section** of the TD-7 is equivalent to the **Drum Part** in a MIDI multi-timbral sound module. In this section, different sounds will be played by corresponding Note Numbers. You can assign a drum voice or a percussion sound to each Note Number. Channel 10 is frequently set for this section.

A **Performance Section** in the TD-7 is equivalent to a **Standard Part** in a MIDI multi-timbral sound module. A Performance Section is used for playing melody or bass parts. Here, Note Numbers control only the pitch of a sound. The TD-7 has three Performance Sections and one Instrument Section, and therefore allows you to play four parts simultaneously; melody, chords, bass and drums.

The **Trigger Transmit Section** converts operation information of the Pad, Footswitch and Pedal into MIDI messages then transmits them to the Instrument Section and Performance Sections. MIDI messages sent from the Trigger Transmit Section are used for recording data into the Phrase Sequencer or transmitted through MIDI OUT.

TD-7 MIDI Flow diagram

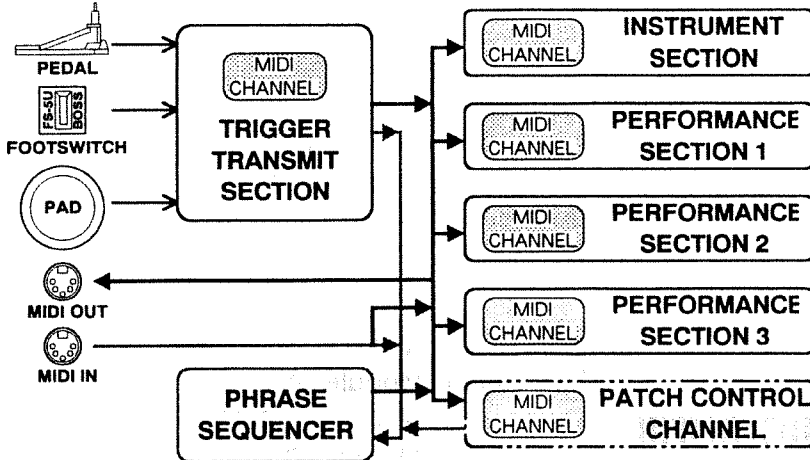

↳ In some models, the "Drum Part" may be called the "Rhythm Part".

↳ In some models, a "Standard Part" may be called a "Normal Part".

* The TD-7 can play 14 notes at once (Maximum Polyphony). If the number of notes used exceeds 14, some sounds will be cut off and the performance cannot be properly recreated.

[2] The TD-7's MIDI Messages

MIDI includes many different messages for conveying various performance aspects. MIDI messages are divided into Channel messages and System messages. Channel messages are sent via the individual MIDI channels, while System messages can be received regardless of the channel settings.

■ Channel Messages

Channel messages include performance controlling information; for instance, "which pad is hit and how hard". How a device will respond to received MIDI messages (how it should sound) is determined by the specifications of that device. Therefore, if the receiving device does not feature the function required by the message sent from the transmitter, nothing may happen.

● Note Messages

Note messages include information related to striking the pads, as shown below. These messages, therefore, are equivalent to Note On messages from a keyboard.

Note Number :	The number assigned to each trigger signal. (The number assigned to each key on a keyboard.)
Note ON :	This type of message is generated when a pad is hit (or a key on a keyboard is pressed).
Note OFF :	This type of message is generated when the Gate Time (length of a note) has elapsed after a pad is hit (or when the key on a keyboard is released).
Velocity :	The strength with which a pad (or key) is played.

Note Numbers 0 - 127 represent the notes on a keyboard. Note number 60 is Middle C (C4).

Correspondence between Note Numbers and Names

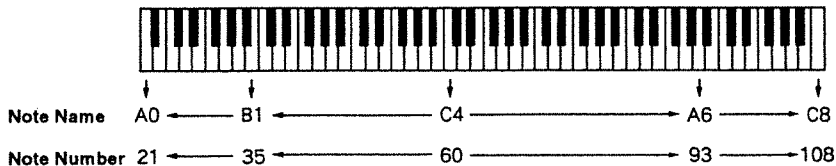

● **Pitch Bend Change**

When a Pitch Bend Change message is received, the pitch will change.

● **Aftertouch**

Aftertouch is a function which allows you to alter sounds by applying pressure to the keys of a keyboard after the notes have been played. Aftertouch includes two kinds of messages: polyphonic key pressure messages, which send information for each key played, and channel key pressure messages, which sends information for the entire channel.

The TD-7 sends polyphonic key pressure messages when the rim of a pad is held and released.

When receiving polyphonic key pressure messages from external MIDI devices, the TD-7 will respond as if you were holding the rim of a pad.

● **Program Change**

Generally, Program Change messages are used for changing sounds. 1 - 128 are valid Program Change Numbers.

The TD-7 allows you to change Patches using Program Change messages.

● **Control Change**

Control Change messages control several functions, such as modulation, pan, etc. Functions are specified by Control Numbers.

The TD-7 system can send Hi-hat Control Pedal information using Control Change messages.

The TD-7 can send Hold messages when the Footswitch mode is set to mode 2. (P. 124)

⚡ **How the Patch Numbers in the TD-7 correspond to Program Change Numbers is explained on page 70.**

■ System Messages

System Messages can be sent no matter how the MIDI channels are set. System messages include exclusive messages, messages for synchronization, etc.

● Realtime Messages

These messages are used for synchronization. The TD-7 can transmit and receive MIDI timing clocks.

● Active Sensing

Active sensing messages monitor the integrity of MIDI connections. Once the TD-7 receives Active sensing messages via MIDI IN, it will automatically look for further messages. In this mode, if the TD-7 does not receive any MIDI messages or Active sensing messages (or other MIDI messages) within 300msec (TD-7), it will judge that the MIDI cable is disconnected or damaged. The unit will cut off all sounds and take exactly the same action as when receiving Reset All Controllers messages. Active Sensing messages will no longer be monitored. The TD-7 can also transmit Active sensing messages.

● Exclusive Messages

Exclusive messages are unique to a particular model and manufacturer (e.g. Patch data). For a detailed explanation, see MIDI Implementation (P. 158)

About MIDI Implementation Chart

MIDI has made it possible for a wide variety of devices to exchange information, but it is not always true that all types of MIDI messages can be exchanged between all types of devices. For example, if you use a synthesizer as a master device to control a digital piano, the pitch bender (the lever or wheel that modifies the pitch) of the synthesizer will have no effect on the sound of the piano. The important thing to keep in mind when using MIDI is that the slave device must be able to 'understand' what the master is 'saying'. In other words, the MIDI messages must be common to both master and slave.

To help you quickly determine what types of MIDI messages can be exchanged between master and slave, the Operation Manual of each MIDI device includes a MIDI Implementation chart (P. 164). By looking at this chart, you can quickly see what messages the device is able to transmit and receive. The left side of the chart lists the names of a variety of MIDI messages, and the Transmission and Reception columns use "o" and "x" marks to indicate whether or not each of these messages can be transmitted or received. This means that a specific MIDI message can be exchanged only if there is an "o" in both the Transmission column of the master and the Reception column of the slave device. MIDI implementation charts are standardized, so you can fold the charts from two manuals together to see at a glance how the two devices will communicate.

For a detailed explanation of the TD-7's MIDI implementation, refer to page 158.

⚠ When the TD-7 receives a Reset All Controllers message, it will reset some of the parameters to the power ON values, e.g. pitch bend, after-touch, etc. For a detailed explanation about the Reset All Controllers message, see page 159.

[3] Setting MIDI Parameters

The following describes how to set the MIDI parameters (such as transmit/receive channels, channel message transmit/receive switches, etc).

■ How to set MIDI Parameters

- ① Select the Patch Play screen, then press [SYSTEM]. The System Screen menu will appear.

Patch Play Screen

P. 17

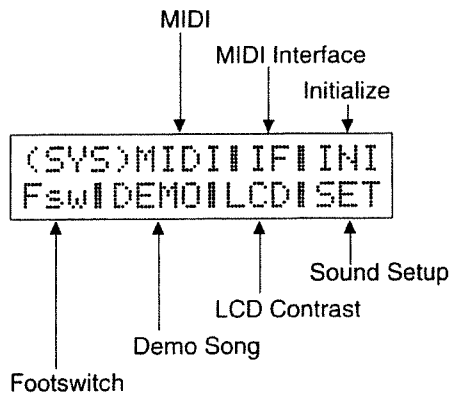

- ② Move the cursor to MIDI, then press [ENTER].

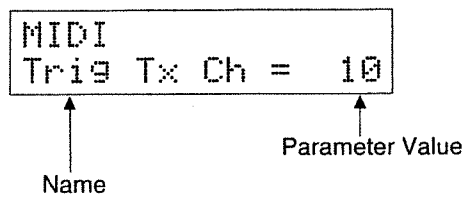

- ③ Select the parameter to be edited using the [DATA] dial.
- ④ Move the cursor using [◀] and [▶], then set the value of the parameter using the [DATA] dial.

MIDI Parameters include the following:

● **Trigger Transmit Channel : Trig Tx Ch (1 - 16)**

```
MIDI
Trig Tx Ch = 10
```

Set the channel to match that set in the Instrument or Performance Sections. Hitting a pad will play the sound of the section that is set to the same channel number as the Trigger Transmit Channel. When the channel is set to a different number, the internal sound source of the TD-7 will not play.

Note messages are sent via MIDI OUT on the channel set here. Messages created using the Hi-hat Control Pedal and Footswitch will also be sent on the same channel.

For drum performances, you may set the Trigger Transmit Channel and the Instrument Section Transmit and Receive Channel (explained in the following section) to 10.

● **Instrument Section Transmit and Receive Channel : Inst Tr Ch (1 - 16)**

```
MIDI
Inst Tr Ch = 10
```

To play the TD-7's internal sound source, set this channel to the same number as the Trigger Transmit Channel. To play the TD-7 using another MIDI device, set this to the same number as the transmit channel of that device.

The Instrument section's sequence data (recorded in the Phrase Sequencer) is output through MIDI OUT on the channel set here.

⦿ Tx in the LCD represents the Transmitter.

* When Midi Out is set to OFF, no messages are transmitted.

⦿ Tr in the LCD represents the Transceiver.

- Performance Section Transmit and Receive Channel : PFM1 Tr Ch / PFM2 Tr Ch / PFM3 Tr Ch (OFF/1 - 16)

```
MIDI
PFM1 Tr Ch = 11
```

```
MIDI
PFM2 Tr Ch = 12
```

```
MIDI
PFM3 Tr Ch = 13
```

To play the internal sound source by hitting the pads, set this channel to the same number as the Trigger Transmit Channel. To play the TD-7 using another MIDI device, set it to the same number as the transmit channel of that device. At OFF, the Performance Section not sounds.

The Performance section's sequence data (recorded in the Phrase Sequencer) is output through MIDI OUT on the channel set here.

- Patch Control Transmit and Receive Channel : Ctrl Tr Ch (1 - 16)

```
MIDI
Ctrl Tr Ch = 10
```

To change Patches, use Program Change messages. When the TD-7 receives a Program Change message on the channel set here, the corresponding Patch will be selected. On the other hand, when you change Patches on the TD-7 using panel controls, the corresponding Program Change message will be sent to the external device on the channel set here.

- Device ID : Device ID (1 - 32)

```
MIDI
Device ID = 17
```

This sets the Device ID for Roland Exclusive messages. Exclusive messages can be sent or received, no matter what channel is currently selected, as long as the Device IDs of two devices are the same.

* When Prg Chg Rx is set to OFF, the TD-7 does not respond to Program Change messages (Patches do not change).

† The relationship between Patch Numbers and Program Change Numbers is shown on page 70.

● **Midi In Switch : Midi In (ON/OFF)**

```
MIDI
Midi In   = ON
```

When it is set to OFF, no MIDI messages are recognized. To control the TD-7 via MIDI, set it to ON.

● **Midi Out Switch : Midi Out (ON/OFF)**

```
MIDI
Midi Out  = ON
```

When this parameter is set to OFF, no MIDI messages are transmitted. To send MIDI messages from the TD-7, be sure to set it to ON.

● **Midi Mix Switch : Midi Mix (ON/OFF)**

```
MIDI
Midi Mix  = OFF
```

When set to ON, a copy of the messages received through MIDI IN will be sent from MIDI OUT. This is called Soft Thru. Messages generated by the TD-7 will be mixed with the received messages and then sent through MIDI OUT. When set to OFF, the Soft Thru effect does not function.

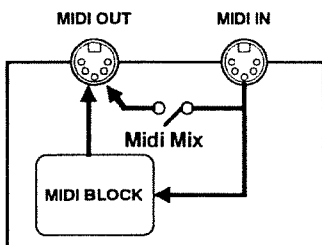

● **Note Off Receive Switch : NoteOff Rx (ON / OFF)**

```
MIDI
NoteOff Rx = OFF
```

When this parameter is set to OFF, Note Off messages are not recognized. When Note Off messages are received, the sound currently being played will be cut off. Normally, this parameter should be set to OFF.

* Bulk Dump data is transmitted regardless of the Midi Out Switch setting.

⇨ Rx in the LCD represents the Receiver.

● **Aftertouch Transmit and Receive Switch : Aftertouch (ON/OFF)**

```
MIDI
Aftertouch = ON
```

When this parameter is set to ON, the TD-7 sends Polyphonic Key Pressure messages when the rim of a PD-7 pad is held and released. When the TD-7 receives Polyphonic Key Pressure messages, the sound currently being played will be suddenly cut off. When set to OFF, the TD-7 does not send or recognize Polyphonic Key Pressure messages.

● **System Exclusive Receive Switch : Sys Exc Rx (ON/OFF)**

```
MIDI
Sys Exc Rx = ON
```

When this parameter is set to ON, the TD-7 can receive Exclusive data. Set it to ON to transfer Bulk Dump data from another TD-7 or to change Patch data. When set to OFF, Exclusive messages will be ignored.

● **Program Change Transmit Switch : Prg Chg Tx (ON/OFF)**
Program Change Receive Switch : Prg Chg Rx (ON/OFF)

```
MIDI
Prg Chg Tx = ON
```

```
MIDI
Prg Chg Rx = ON
```

Set both parameters to ON to send or receive Program Change messages.

● **Hold Receive Switch : Hold Rx (ON/OFF)**

```
MIDI
Hold Rx = OFF
```

When set to ON, Hold messages in Control Changes (Control Number 64) will be recognized. The TD-7 can control the decay time of an Instrument by changing the value of the Control Change. When OFF, the TD-7 ignores Hold messages.

◁ Tx in the LCD represents the Transmitter.

◁ Rx in the LCD represents the Receiver.

● Pan Receive Switch : Pan Rx (ON/OFF)

```
MIDI
Pan Rx      = OFF
```

When set to ON, Pan messages in Control Changes (Control Number 10) are recognized. When set to OFF, the TD-7 ignores Pan messages.

● Volume Receive Switch : Volume Rx (ON/OFF)

```
MIDI
Volume Rx   = OFF
```

When set to ON, the TD-7 recognizes the Main Volume (Control Number 7) in Control Change messages. That is, the volume of the section (that is set to the same MIDI channel number) can be controlled via MIDI. When set to OFF, the TD-7 ignores Volume messages.

● Instrument Section Level : Inst Level (0 - 15)

```
MIDI
Inst Level  = 15
```

This parameter sets the level of the Instrument Section. It can therefore be used for adjusting the volume balance with the Performance Sections. At 0, no sound is output.

● Local Control : Local Ctrl (ON/OFF)

```
MIDI
Local Ctrl = ON
```

On the TD-7, the MIDI channels of the Trigger Block and Sound Block are set to the same number (connected) so that the internal sound source can be played. "Local Control" (ON/OFF) determines whether the Trigger Block and Sound Module Block are connected or not. When "Local Control" is not set to OFF, the Sequencer Block and Sound Block are disconnected.

When ON, the Sound Module Block is active, and the internal sound source can be played using the pads or pedals. When OFF, no sound is produced.

Normally, set this to ON

Regardless of the setting, the internal sound source is played by messages received via MIDI IN, and performance information of the pads and pedals is sent through MIDI OUT.

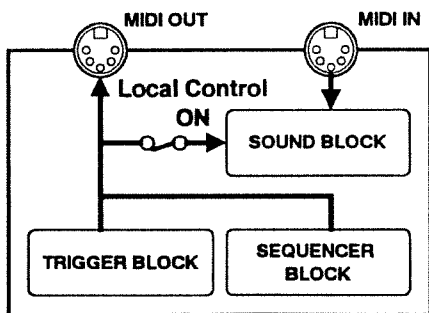

TD - 7

Set the Local Control to OFF in the following situations:

To connect a MIDI device (sequencer, personal computer, etc.) that usually works in the Soft Thru mode, set the "Local Control" to OFF.

A MIDI device that usually works in the Soft Thru mode will return the MIDI messages sent from the TD-7. If "Local Control" is ON, the messages generated in the Trigger Block, and those that have been returned from the external device, will cause problems.

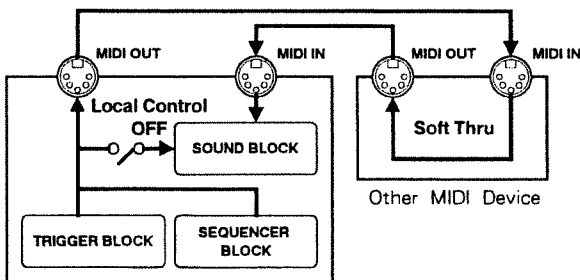

TD - 7

* When Midi Out and Midi In are OFF, no MIDI messages will be sent or received. * P. 117

● Pitch Bend : Pitch Bend (OFF/1 - 12)

```
MIDI
Pitch Bend = OFF
```

This parameter sets the maximum amount of pitch change caused by received Pitch Bend messages in semi-tone. Higher values will cause a greater pitch change. When set to OFF, the TD-7 will ignore Pitch Bend messages.

● Control Change : Ctrl Chg (FOOT/MODU/HOLD/GNL1/GNL2)

```
MIDI
Ctrl Chg =FOOT
```

The TD-7 transmits Control Change messages that describe how the Hi-hat Control Pedal (FD-7) is being used:

FOOT	Control Number 4 (Foot Controller) is transmitted.
MODU	Control Number 1 (Modulation) is transmitted.
HOLD	Control Number 64 (Hold) is transmitted.
GNL1	Control Number 16 (General Purpose Controller 1) is transmitted.
GNL2	Control Number 17 (General Purpose Controller 2) is transmitted.

For example, if FOOT is selected, the TD-7 transmits a Control Change value that indicates how far the Hi-hat Control Pedal has been pressed.

If the TD-7 receives the Control Change messages set above, it will respond as if the Hi-hat Control Pedal were being used.

When MODU is selected, a Hi-hat performance can be simulated by playing a keyboard. Play the key set to the Note Number that is assigned to the Hi-hat Control Pedal (P. 68) and use the Modulation Wheel on the keyboard. By doing so, you can obtain an effect similar to that when using the Hi-hat Control Pedal.

⇒ For a detailed explanation about how the TD-7 responds when the Hi-hat Control Pedal is used, refer to page 65.

* Control Change messages that the TD-7 can transmit and receive are limited to one of those shown above.

● **Bulk Dump : Bulk Dump**

A 'Bulk Dump' is the transferring of Patch or Phrase Sequencer data to an external device (via MIDI OUT). This makes it possible to transfer the TD-7's data to a sequencer or personal computer. If you wish to set two TD-7's to exactly the same settings, you can do so simply by a bulk-dump of data from one to the other.

When you select **BULK DUMP**, the screen will respond with:

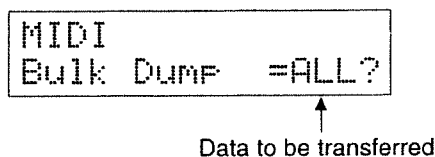

After selecting **BULK DUMP**, follow the procedure after step ③ on page 114.

- ④ Move the cursor using [←] and [→], then select one of the data types to be transferred using the [DATA] dial.

ALL	All the TD-7's data will be transferred (approximately 84 kbyte).
PCH	Patch data (P. 37) is transferred (approximately 52 kbyte).
INS	Instrument data (P. 78) is transferred (approximately 18 kbyte).
SEQ	Data in the Phrase Sequencer (P. 92) is transferred. (approximately 13 kbyte).
SYS	System (P. 35), Global Performance Parameters (P. 73), and Patch Chain (P. 25) data is transmitted (approximately 0.5 kbyte).

- ⑤ Press [ENTER].

The screen responds with **Are you sure?**.

- ⑥ Press [ENTER].

The screen displays the message **Now sending**.

When the Bulk Dump is complete, the screen will display the message **Completed**.

- When the transmitting device starts transferring data, the display of the TD-7 responds with **Receiving SysEx**.

* The amount of Bulk Dump data is large. Be sure to check the available memory in the receiving MIDI device before you proceed. If there is insufficient memory space in the receiving device, the transfer of data cannot take place.

* Set the System Exclusive Receive Switch on the receiving device to ON. If it is set to OFF, the unit will not receive the Bulk Dump data.
☞ P. 118

* Do not hit the Pad or play the Sequencer while the TD-7 is receiving data.

2. Setting the Interface Mode

The TD-7 provides a choice of 3 operational modes. These are the Standard, Trigger MIDI Interface, and MIDI Sound Module modes. Ordinarily, the unit can be left set at the Standard mode.

■ How to Set the Interface Mode

- ① From the Patch Play screen, press [SYSTEM], and confirm that you have the System screen's menu in view.

```
(SYS)MIDI I F I N I  
F s w I D E M O I L C D I S E T
```

- ② Using [◀] [▶], move the cursor to IF, then press [ENTER].

```
INTERFACE  
MODE= STANDARD
```

Standard Mode

- ③ By moving the [DATA] dial, you can select between the screens shown below, thus making your choice for the mode.

```
INTERFACE  
MODE= MIDI-SOUND
```

MIDI Sound Module Mode

```
INTERFACE  
MODE= TRIG-MIDI
```

Trigger MIDI Interface Mode

The various modes and the functions they provide are as follows:

Standard Mode : STANDARD

Ordinarily, the unit can be left set to this mode. When you strike the pads, the internal sound sources will produce sound. At the same time, MIDI messages that arrive from an external unit will also result in the production of sound. However, while in this mode, priority is given to the pads' trigger signals and the sounds they produce.

MIDI Sound Module Mode : MIDI-SOUND

When set to this mode, sound will not be produced when the pads are struck. However, sound will be produced with respect to all MIDI Note On messages that are received. Since the TD-7 does not perform the conversion of trigger signals to MIDI messages in this mode, there is an increase in the speed at which it produces the notes after they have arrived as MIDI messages. This mode can be conveniently used when you wish to use the TD-7 as a MIDI sound module.

Trigger MIDI Interface Mode : TRIG-MIDI

Since the TD-7 is capable of transmitting MIDI messages that correspond with the trigger signals that are generated by the pads, it can be thought of as a device which converts trigger signals to MIDI signals. Such a device is called a **Trigger MIDI Interface**.

This mode should be selected when you wish to use the unit as a Trigger MIDI Interface, when connected with a MIDI sound generating unit such as a sampler. While in this mode, the TD-7's internal sound sources are deactivated, so the speed at which trigger signals are converted to MIDI signals increases. As a result, the MIDI sound generating unit can produce the sound much faster, with a minimum of delay occurring after the instant a pad is struck. However, the TD-7's internal sound sources will not sound.

⇨ At the factory default settings, the unit is set to use the Standard mode.

⇨ Patch Play screen
☞ p. 17

* Note that while in the Trigger MIDI Interface Mode, the TD-7's internal sound sources will no longer generate any sound.

3. Using the Footswitch and Sound-on-Sound

The TD-7 is equipped with a jack for connection of footswitches. This stereo jack allows connection of two footswitches when using a special cable (PCS-31: optional). Use BOSS FS-5U footswitches (optional).

The footswitch side of the connection cable has two monaural plugs. The footswitch connected to the plug with the white line is Footswitch 1 and the other is Footswitch 2.

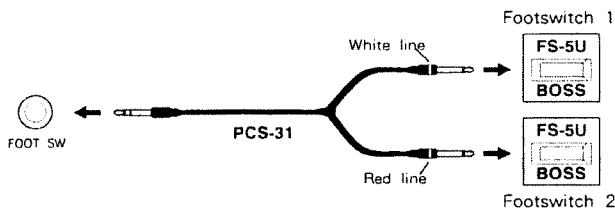

When a DP-2 footswitch (optional) is connected to the Footswitch Jack, Footswitch 2 will have no effect.

[1] How to set the Footswitch Mode

- ① Select the Patch Play screen, then press [SYSTEM] to select the System screen menu.

```
(SYS)MIDI I F I N I
F SW I D E M O I L C D I S E T
```

- ② Move the cursor to F SW, then press [ENTER].

```
Foot Sw = Mode 1
#1UP      #2DOWN
```

- ③ Select one of the three modes using the [DATA] dial.

Mode 1 Mode 1	This mode allows you to change Patches using the footswitches.
Mode 2 Mode 2	This mode allows you to use the footswitches to sustain sounds and change Patches.
S on S Sound-on-sound Mode	This mode allows you to use the Sound-on-Sound function.

● Mode 1

```
Foot Sw = Mode 1
#1UP      #2DOWN
```

When Mode 1 is selected, the two footswitches are set to Mode 1.

Mode 1 is for changing Patches with the footswitches. Pressing footswitch 1 increases the Patch Number while footswitch 2 decreases it. If you depress and hold down either footswitch, the Patch Numbers will change continuously.

In Mode 1, the footswitches function in the same way as the [◀] and [▶] buttons in the Patch Play screen. Footswitch 1 corresponds to the [▶] button, while Footswitch 2 corresponds to the [◀] button.

● Mode 2

```
Foot Sw = Mode 2
#1UP/DOWN #2HOLD
```

When Mode 2 is selected, the two footswitches are set to Mode 2.

In Mode 2, footswitch 1 changes Patches and footswitch 2 sustains the sound.

Each time you press footswitch 1 the Patch Number will increase. Pressing footswitch 1 twice quickly will decrease the number. If you depress and hold footswitch 1, the Patch Numbers will increase continuously.

If you depress and hold footswitch 2 while you play, the currently selected sound will be sustained. This is called the Hold effect.

* When Mode 1 is selected, the Sound-on-Sound function cannot be used. To use that function, select S on S.

◀ Patch Play Screen **▶** P. 17

* When Mode 2 is selected, the Sound-on-Sound function cannot be used. To use that function, select S on S.

* To use the Hold function, set the Hold Receive Switch (P. 118) to ON. If it is OFF, the Hold effect cannot be obtained.

◀ When Mode 2 is selected, pressing footswitch 2 will send a Hold message (Control Number 64).

[2] Using the Sound-on-Sound Function

Sound-on-Sound is a function that allows you to record the phrase currently being played and then play it back immediately. It uses the Loop Recording method that allows you to record sounds as many times as you like (by layering them). Because footswitches can be used for quick recording and playback during real-time performances, one person can play several parts at once.

■ How to use Sound-on-Sound

- ① Select the Patch Play screen, then press [SYSTEM].

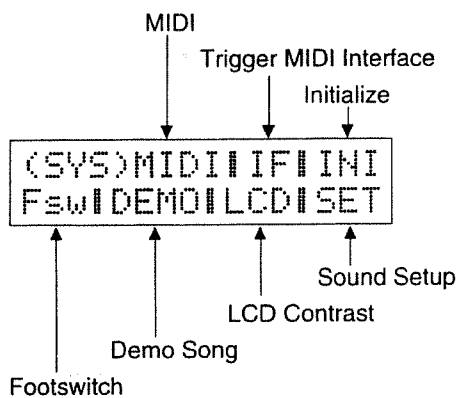

Patch Play screen

EN P. 17

- ② Move the cursor to Fsw, then press [ENTER].

```
Foot Sw = Mode 1
#1UP      #2DOWN
```

- ③ Select S on S using the [DATA] dial.



```
Foot SW = S on S
#1SP/UP/DW #2REC
```

The following explains the Interval and Quantize.

● **Interval (1/4, 1/8, 1/12, OFF)**

This parameter sets the playback tempo of Sound-on-Sound data. You start recording by depressing footswitch 2 then hitting a pad. The time interval between these two events determines the basic tempo.

You can select 1/4, 1/8, 1/12 or OFF. The timing value you select here is set as the 'beat' of the selected note.

1/4	A quarter note	
1/8	An eighth note	
1/12	Quarter note triplets	
OFF	No quantization	

● **Quantize [1/8, 1/12, 1/16, 1/24, 1/32, 1/48, 1/64, HIGH (1/96)]**

The quantize function corrects timing inaccuracies that occur during recording. For instance, if you set it (resolution) to 1/16, all the sixteenth notes in your sequence will fall precisely on the sixteenth note divisions in each measure. [Notes of longer duration will fall on their respective divisions as well.] Normally, this setting should reflect the smallest note value in your sequence. When set to HIGH, no quantization will be applied to what you play.

Example: 1/16 resolution

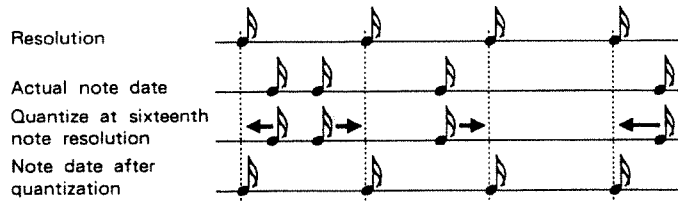

Recorded data

The maximum length of data that can be recorded when using Sound-on-Sound is 112 beats (with the quarter note setting). That is, 28 measures in 4/4, or 37 measures in 3/4.

The Sound-on-Sound and Phrase Sequencer (P. 92) data are recorded in the common memory area. If the Phrase Sequencer data is too large, the Sound-on-Sound data cannot be recorded. If this happens, check the available memory area with the Available Memory function (P. 105) and reduce the amount of data you want to record.

* If the interval is too long, the phrase cannot be recorded.

* When OFF is selected, the basic tempo is not set and no quantization is applied.

4. The Sound Setup

The TD-7's Instruments can be assigned to one of the three outputs: Stereo Output, Send 1 or Send 2. (P. 88) The Send 1 signal can be sent to either Effect 1 or Individual Output 1. Similarly, the Send 2 signal can be sent to either Effect 2 or Individual Output 2. The setting of the Sound Setup determines which of the Effect or Individual Output will be used. The setting of the Sound Setup is common to all the Instruments. For example, selecting Effect 1 will send all the Instruments to the Effect 1 output and no signal is output from Individual Output 1. (P. 131)

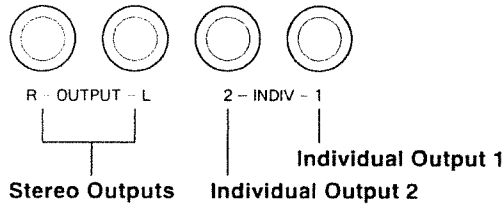

■ How to set the Sound Setup

- ① Select the Patch Play screen, then press [SYSTEM].

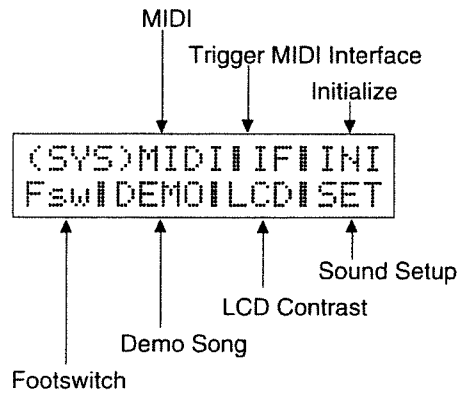

- ② Move the cursor to SET, then press [ENTER].

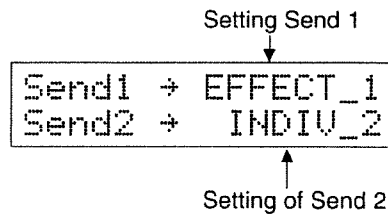

◁ Patch Play Screen

▷ P. 17

- ③ Select Send 1 using the [DATA] dial.

Send1

EFFECT_1	All Instruments assigned to Send 1 are sent to Effect 1, mixed, and then output through the Stereo Outputs.
INDIV_1	All Instruments assigned to Send 1 are output through Individual Output 1.
OFF	All Instruments assigned to Send 1 are muted.

- ④ Move the cursor to the lower line using [◀] and [▶], then set Send 2 (Send2) using the [DATA] dial.

Send2

EFFECT_2	All Instruments assigned to Send 2 are sent to Effect 2, mixed, and then output through the Stereo Outputs.
INDIV_2	All Instruments assigned to Send 2 are output through Individual Output 2.
OFF	All Instruments assigned to Send 2 are muted.

■ Audio Output and Effects

Levels for three parameters can be set for the TD-7's Instruments. ■ P. 88

Output Level Send 1 Level Send 2 Level

The Sound Setup determines the output mode of Send 1 and Send 2.

The signal of Send 1 can be selected as either:

- ① Input to Effect 1 (Reverb/Delay)
- ② Output from Individual Output 1

The signal of Send 2 can be selected as either:

- ① Input to Effect 2 (Chorus/Flanger)
- ② Output from Individual Output 2

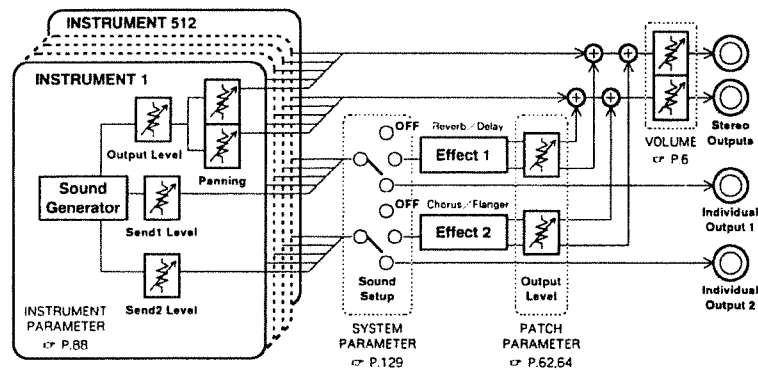

- What is set in Send 1 and Send 2 is common to all the Instruments, that is, if you select "Output through Individual Output 1", Effect 1 cannot be used. Therefore, it is not possible to "apply reverb to a certain Instrument and output a different Instrument through Individual Output 1".
- If you wish to output a specific Instrument through an Individual Output, set the Send Levels of the other Instruments to zero.
- The level of the Stereo Out for each Instrument can be set with the Output Level (P. 87) of each Instrument.
- The Send Level (P. 88) of each Instrument works as an Individual Output Level, when Individual (INDIU) is selected in the Sound Setup. If, however, Effect (EFFECT) is selected, it works as an Effect Send Level.

5. Initialization

The TD-7 features two types of initialization: one is initializing all the parameters to the factory preset values (P. 150) and the other is optimizing the Hi-hat Control Pedal function to the most appropriate value.

[1] Hi-hat Control Pedal Initialize

This function allows you to set the FD-7 Hi-hat Control Pedal (optional) for the best possible performance results. Once you have initialized the TD-7 for the FD-7, the values will be retained even after you switched off the TD-7.

- ① Connect the FD-7 Hi-hat Control Pedal to the Hi-hat Control Jack (HH CONT) on the TD-7. Do not depress the Hi-hat Control Pedal.
- ② Select the Patch Play screen, then press [SYSTEM].

```
(SYS)MIDI|IFI|INI  
F≡w|DEMO|LCD|SET
```

- ③ Move the cursor to INI using [◀] and [▶], then press [ENTER].

```
INITIALIZE HiHat  
HiHat INIT? = 14
```

↑
The value to be set

Pressing [ENTER] will execute the Initialization procedure, setting the Hi-hat parameters to the most appropriate values. If you wish to change values, move the cursor to the value field, then rotate the [DATA] dial.

[2] All Initialize

The All Initialize function returns all the data in the TD-7 to the factory presets. This will automatically erase any previous data in the internal memory of the TD-7. So, if you wish to retain the original data, save it onto another MIDI device using the Bulk Dump function (P. 122) or make a memo as to the settings.

- ① Select the Patch Play screen, then press [SYSTEM].
- ② Move the cursor to INT using [◀] and [▶], then press [ENTER].

```
INITIALIZE HiHat
HiHat INIT? = 14
```

- ③ Move the cursor to HiHat using [◀] and [▶], then select ALL by rotating the [DATA] dial.

```
INITIALIZE ALL
TD-7 ALL INIT ?
```

- ④ Press [ENTER], and the screen will respond with Are you sure?
 - ⑤ Press [ENTER] again, and the All Initialize will be performed.
To cancel the All Initialize, press [EXIT] instead of [ENTER].
- If you wish to reset only the Patch data, copy the factory preset Patch data into the User area using the Patch Copy function (P. 71).
 - If you wish to reset only the Instrument data, copy the factory preset data into the User area using the Instrument Copy function (P. 89).

* Copying factory preset data into the User Patches, Instruments and Sequence Patterns will automatically overwrite (replace) any data stored there.

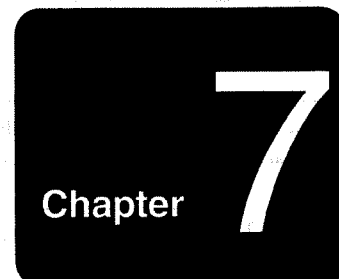

Reference

1. Error Messages	136
2. Troubleshooting	138
3. Patch List	141
4. Waveform List	144
5. Instrument List	146
6. Initial Setting	150
7. Blank Chart	153

1. Error Messages

When any operational error or problem occurs, the screen will display an error message. If this happens, refer to the following section for help.

```
Serial error
Press any key
```

The unit could not receive MIDI messages correctly.

→ If this error message appears frequently, consult your Roland retailer or the local Roland service center.

Pressing any button on the panel of the unit will retrieve the previous screen.

```
MIDI buffer full
Press any key
```

The unit received an excessive amount of MIDI data from an external MIDI device.

→ Reduce the amount of MIDI data transmitted from the external MIDI device. Alternatively, send data over a longer interval so that the amount of data sent each time will be reduced.

Pressing any button on the panel of the unit will retrieve the previous screen.

```
Act sensing err
Press any key
```

A connecting MIDI cable may be damaged or disconnected.

→ Check the MIDI cable and all connection.

Pressing any button on the panel of the unit will retrieve the previous screen.

```
Check sum error
Press any key
```

The unit could not receive Exclusive data properly.

→ Check the MIDI cable and data to be transmitted, then send the data again.

Pressing any button on the panel of the unit will retrieve the previous screen.

```
DC-VOLT abnormal
Press any key
```

The signal fed into the Trigger Input section is of abnormally high voltage. Be sure to use pads with the proper output voltage.

Pressing any button on the panel of the unit will retrieve the previous screen.

If the previous screen cannot be retrieved, contact your local Roland Service Center.

In addition, if you hit the pads when power is turned on, this error message could appear in the display. In this case, turn the power on again.

```
Invalid input
```

This message appears when the same number has been assigned to the source and the destination number in Patch Copy/Pattern Copy/Instrument Copy, etc.

→ Select different numbers for source and destination.

The previous screen will be recalled in several seconds.

Ptn memory full

No more sequence patterns can be written into memory.

→ If you wish to continue to record, erase some unnecessary sequence patterns.

The previous screen will be recalled in several seconds.

Empty pattern

You are trying to erase a Sequence Pattern in which no data exists.

→ Select a Sequence Pattern that contains data.

The previous screen will be recalled in several seconds.

Not correspond

The Trigger Transmit Channel (⇨ P. 115) is not set to the same number as the Instrument Section's Transmit and Receive channel (⇨ P.115), or the Performance Section's Transmit and Receive channel (⇨ P.116). Therefore, you cannot select an Instrument.

→ Set the Trigger Transmit Channel to the same number as the Instrument Section's Transmit and Receive channel or the Performance Section's Transmit and Receive channel.

The previous screen will be recalled in several seconds.

Battery low
Press any key

The battery that supports the backup system of the internal memory is nearly exhausted.

→ All data stored in the internal memory may be lost. Have the local Roland Service Center replace the battery as soon as possible.

Backup NG
INITIALIZE?

The internal data of the TD - 7 is damaged.

→ Data cannot be restored unless it is initialized. Follow this Initialization procedure:

① Press [ENTER].

Are you sure?
INITIALIZE?

② Pressing [ENTER] again will recall the Patch Play screen.

* The above initialization procedure will set all the data in the TD - 7 to the factory preset values.

2. Troubleshooting

Instrument

● No sound is heard.

Make sure that the TD - 7 is connected securely and correctly to the amplifier.

→ Connect the TD - 7 to the amplifier securely and correctly.

Make sure that the signal is not output to Individual Output 1 or 2.

→ Connect the amplifier to Individual Output Jack 1 or 2.

Make sure that the Instrument's Output Level is not set to zero.

→ Set the Output Level to an appropriate level. (⇐ P. 87)

Make sure the Midi In Switch in the System screen is not set to OFF.

→ Set the Midi In Switch to ON.(⇐ P.116)

Make sure that the Local Control Switch in the System screen is not set to OFF.

→ Set the Local Control Switch to ON. (⇐ P.120)

Make sure that the Trigger Interface Mode in the System screen is not set to the Trigger MIDI Interface Mode or MIDI Sound Module mode.

→ If so, change it to the Standard mode.(⇐ P. 123)

If you are going to play the Instrument Section, make sure that the Instrument Section Transmit and Receive channel is set to the same number as the Trigger Transmit channel. Or make sure that Instrument Section Level is not set to 0.

→ Set the Instrument Section Transmit and Receive channel to the same number as the Trigger Transmit channel. (⇐ P. 115)

→ Set the Instrument Section Level to an appropriate level.(⇐ P. 119)

If you are going to play a Performance Section, make sure that the Performance Section Transmit and Receive channel is set to the same number as the Trigger Transmit channel. Or make sure that the Global Performance Level is not set to 0.

→ Set the Performance Section Transmit and Receive channel to the same number as the Trigger Transmit channel. (⇐ P. 116)

→ Set the Global Performance's Level to an appropriate level.(⇐ P. 74)

● The sound level is too low.

Check if the volume of the amplifier is set too low.

→ If so, raise the volume of the amplifier.

Check if the volume of the TD - 7 is set too low.

→ If so, raise the volume of the TD - 7.

● The sound of an Instrument is strange.

Check if the Instrument Parameters are set properly.

→ If not, set the Instrument Parameters properly. (⇐ P. 78)

● Playing a pad with the Choke function set to ON will produce the sound with a short decay.

Check if a pad other than a PD - 7 is connected to a Trigger Input Jack.

→ If so, set the Choke function to OFF. (⇐ P. 45)

● The volume doesn't change with different playing dynamics.

Check if the Velocity Sense Curve is set to Fix.

→ If so, change the Velocity Sense Curve to Normal. (⇨ P.44)

The volume you expect cannot be obtained if the Max Dynamic and Minimum Dynamic are set improperly.

→ Change the settings of the Max Dynamic and Minimum Dynamic. (⇨ P.46)

● When you play the pads quickly in sequence, some pads do not sound.

Check if the Mask Time is set too long.

→ If so, lower the Mask Time value. (⇨ P. 47)

● No sound is produced if you play softly.

Check if the Threshold Level is set too high.

→ If so, lower the Threshold Level.

● Effect 1 (or Effect 2) does not work.

Check if the OFF or INDIV_1 (or INDIVID_2) is set in the Sound Setup.

→ If so, change the settings of the Sound Setup.(⇨ P. 129)

Phrase Sequencer

● No sound is produced even by playing back a Sequence Pattern.

Check if you are playing back a blank Sequence Pattern (where no data exists).

→ If so, select a Sequence Pattern where data is recorded.

Check if you are playing back a Sequence Pattern where only the Control Change messages are recorded.

→ If so, select a different Sequence Pattern.

● Indicators flash in the Patch Play screen.

Check if you are playing back a blank Sequence Pattern (where no data exists).

→ If so, stop playback by playing the pad that caused the blank Sequence Pattern to play or by moving to the Pattern Play in the Sequencer screen.

● None of the Pattern Numbers 25 – 48 can be selected in the Sequence Pattern creation mode.

→ Remember that Pattern Numbers 25 – 48 are preset patterns and therefore cannot be recorded. (⇨ P. 96)

● The Tempo cannot be edited while a Sequence Pattern is being recorded.

Check if the Sync Mode is set to MIDI.

→ If so, change it to INTERNAL. (⇨ P. 105)

● When you start the Phrase Sequencer via MIDI, a pattern different from what is selected is played.

Check if the same Note Number is assigned to more than one Trigger Signal. When the same number is assigned to more than one Trigger Signal, one Sequence Pattern Number is selected in the priority sequence of TRIG1, RIM1, TRIG2, RIM2 RIM9 and PEDAL.

→ If so, change the Note Numbers. (⇨ P. 42)

System

● **The sound is cut when the TD - 7 is played in the Multi - timbral mode.**

Check if the number of voices used exceeds the maximum of 14.

→ If so, lower the number of voices to be played simultaneously.

● **Patches on the unit are not changed even when it receives Program Change messages.**

Check if the Program Change Receive Switch in the System screen is set to OFF.

→ If so, set the Program Change Receive Switch to ON. (⇨ P. 118)

● **The unit does not receive System Exclusive Messages.**

Check if the System Exclusive Switch is set to OFF.

→ If so, change the System Exclusive Switch to ON. (⇨ P. 118)

● **Bulk dump data cannot be transferred completely.**

Check if the amount of available memory in the receiving MIDI device is sufficient.

→ Be sure that there is sufficient memory available in the receiving MIDI device.

● **Sound - on - sound recording is not possible.**

Check if there is sufficient memory available. (⇨ P. 127)

→ If not, erase some unnecessary data, then repeat the recording. (⇨ P.105)

Determine if the interval between pressing footswitch 2 and hitting a pad was too long.

→ If so, repeat recording using a shorter interval.

● **The screen on the TD - 7 is difficult to read.**

Check if the LCD Contrast is set properly.

→ If not, change the LCD Contrast so that you can read the screen easily.

● **You cannot hold(sustain) a sound.**

When "CtrlMode" in the Pedal Parameters (⇨ P.67) or Global Performance Parameters (⇨ P.74) is set to "Decay", the Hold function cannot be obtained in that section.

● **You cannot play back the Hi-hat Control Pedal information recorded in the Phrase Sequencer.**

When the System Parameter is set to "Ctrl Chg = HOLD" (⇨ P.121) and "Hold Rx = OFF" (⇨ P.118), the Hi-hat Control Pedal operation information is converted to Hold messages, and therefore cannot be sent to the internal sound source.

→ Set the "Ctrl Chg" to a status other than "HOLD", or set it to "Hold Rx = ON".

● **Unexpected sounds are heard when you play the TD-7 with an external MIDI sequencer.**

Check if the TD-7's Phrase Sequencer is playing.

→ Set the Sequence Pattern Number set at the Trigger signal to "OFF". (⇨ P.44)

● **The sensitivity of pads seems weak, and appropriate sound is difficult to obtain.**

Did you hit the pads immediately after turning the power on?

→ When power is turned on, you should never attempt to hit the pads until after the Patch Play screen (⇨ P.17) has appeared. If you hit the pads when power is turned on, a "DC-VOLT abnormal" error message could appear in the display. In this case, turn the power on again.

● **On occasion, no sound is heard when a pad is struck; or, the tempo slows down when the Phrase Sequencer is playing back something.**

Check if other devices are sending System Exclusive data to the TD-7.

→ Do not hit the Pads or play the Sequencer while the TD-7 is receiving System Exclusive data.

● **The setting for the Threshold Level, a Trigger parameter, tends to get altered.**

If set to use the Automatic Parameter Setting (⇨ P.45), the Threshold Level for pads which are not hit is set automatically. This is an intelligent feature which is designed to eliminate the crosstalk that might occur between pads. If you wish to have the Threshold Level at a different setting, follow the procedure on page 42, 47 to make the setting again.

3.Patch List

Factory Preset Patch Data					
Patch Number	Program Change Number	Display	Patch Name	Pedal Control Mode	Remark
1	65	Monstr	Monster kit	HiHat1	Tom1-4 : Rim sound is the same as Head sound
2	66	RokSld	Rock Solid kit	HiHat1	↑
3	67	DryDrs	Dry Drums kit	HiHat1	↑
4	68	Reverb	Reverb Drums kit	HiHat1	↑
5	69	90's	90's kit	HiHat1	↑
6	70	Rave	Rave kit	HiHat1	↑
7	71	Jnkyrd	Junkyard kit	HiHat1	↑
8	72	X fade	Crossfade kit	HiHat1	↑
9	73	Dopey	Dopey kit	HiHat1	↑
10	74	Oldies	Oldies kit	HiHat1	↑
11	75	House	House kit	HiHat1	↑
12	76	Rocker	Rocker kit	HiHat1	↑
13	77	Funk	Funk kit	HiHat1	↑
14	78	Robo	Robo kit	HiHat1	
15	79	Latin	Latin kit	HiHat1	
16	80	Nashvl	Nashville kit	HiHat1	↑
17	81	August	August kit	HiHat1	
18	82	Chickn	Chicken kit	HiHat1	
19	83	Blues	Blues kit	HiHat1	Crash Rim : Seq. pattern 34
20	84	Remix	Remix kit	HiHat1	Tom1Rim : Seq. pat. 31 Tom2Rim : Seq. pat. 32
21	85	Stroke	Stroke kit	HiHat1	Tom1-4 Rim : Seq. pattern 45-48
22	86	Junctn	Junction kit	HiHat1	Tom1Rim : Seq. pat. 44 CrashRim : Seq. pat. 30
23	87	Dance	Dance kit	HiHat1	Tom1Head : Seq. pat. 25 Tom2Head : Seq. pat. 28
24	88	Percus	Percussion kit	Pitch-W	SnareHeadRim, Hi-hatHeadRim : Seq. pattern 43
25	1	Stndrd	Standard kit	HiHat2	GM System. GS Format.
26	9	Room	Room kit	HiHat2	GS Format.
27	17	Power	Power kit	HiHat2	↑
28	25	Electr	Electronic kit	HiHat2	↑
29	26	TR-808	TR-808 kit	HiHat2	↑
30	33	Jazz	Jazz kit	HiHat2	↑
31	41	Brush	Brush kit	HiHat2	↑
32	49	Orches	Orchestra kit	OFF	↑ RideHead : Seq. pat. 25 RideRim : Seq. pat. 27

* ↑ : same as above

* Patches 25 are to be played with the GM Score (Drum Part).

* Patches 25-32 are to be played with the GS music data (Drum Part).

* To play the TD-7 with an FD-7, change the Hi-hat Control Pedal Mode of Patches 25-31 from HiHat2 to HiHat1. (☞ P.66)

Performance Section Sound (Factory preset)

Patch No.	Patch Name	Section 1 (for Bass)	Section 2 (for Chord)	Section 3 (for Solo)
1	Monster kit	510:Syn1 . B	501:Gt50p. E	498:OrHit. E
2	Rock Solid kit	508:Slap . B	499:GtHit. E	428:Glock. M
3	Dry Drums kit	509:Acous. B	430:MarIL. M	431:MarIU. M
4	Reverb Drums kit	508:Slap . B	433:VibeL. M	434:VibeU. M
5	90's kit	511:Syn2 . B	499:GtHit. E	465:Rand1. E
6	Rave kit	510:Syn1 . B	499:GtHit. E	445:Drop . E
7	Junkyard kit	506:Melo4. E	340:CowH . P	436:Game1. M
8	Crossfade kit	507:Jazz . B	435:Xylop. M	455:Hoo! . E
9	Dopey kit	511:Syn2 . B	395:Can2 . P	501:Gt50p. E
10	Oldies kit	509:Acous. B	433:VibeL. M	434:VibeU. M
11	House kit	511:Syn2 . B	427:80Cow. P	437:Game2. M
12	Rocker kit	508:Slap . B	499:GtHit. E	342:Tamb1. P
13	Funk kit	507:Jazz . B	500:Gt5Mt. E	501:Gt50p. E
14	Robo kit	349:TriMt. P	456:Iron . E	323:8080H. H
15	Latin kit	509:Acous. B	432:StlDr. M	429:Kalim. M
16	Nashville kit	509:Acous. B	430:MarIL. M	431:MarIU. M
17	August kit	508:Slap . B	433:VibeL. M	501:Gt50p. E
18	Chicken kit	510:Syn1 . B	432:StlDr. M	498:OrHit. E
19	Blues kit	507:Jazz . B	433:VibeL. M	434:VibeU. M
20	Remix kit	510:Syn1 . B	504:Melo2. E	506:Melo4. E
21	Stroke kit	508:Slap . B	430:MarIL. M	431:MarIU. M
22	Junction kit	508:Slap . B	432:StlDr. M	501:Gt50p. E
23	Dance kit	511:Syn2 . B	430:MarIL. M	437:Game2. M
24	Percussion kit	507:Jazz . B	432:StlDr. M	391:DjmbL. P
25	Standard kit	507:Jazz . B	430:MarIL. M	431:MarIU. M
26	Room kit	507:Jazz . B	503:Melo1. E	501:Gt50p. E
27	Power kit	507:Jazz . B	430:MarIL. M	431:MarIU. M
28	Electronic kit	510:Syn1 . B	499:GtHit. E	508:Slap . B
29	TR-808 kit	510:Syn1 . B	481:RevT . E	459:Nois1. E
30	Jazz kit	507:Jazz . B	433:VibeL. M	434:VibeU. M
31	Brush kit	509:Acous. B	433:VibeL. M	434:VibeU. M
32	Orchestra kit	509:Acous. B	431:MarIU. M	498:OrHit. E

Phrase Sequence Pattern (Factory preset)

Pattern No.	Contents	Type	played Section	Patch (assigned Trigger)	recommended Instrument
25	Chromatic Scale	Tap1A	Pfm3	Patch 23 (T4), 32 (T8)	-
26	Major Scale	Tap1A	Pfm3	Patch 32 (R8)	-
27	Minor Scale	Tap1A	Pfm3	-	-
28	Arpeggio	Tap2A	Pfm3	Patch 23 (T5)	-
29	Random	Tap4A	Pfm3	-	-
30	16beat Backing	LoopB	Pfm1, 3	Patch 22 (R9)	Pfm3:Gt50p. E
31	Dance A Backing	LoopB	Inst, Pfm1, 3	Patch 20 (R4)	-
32	Dance B Backing	LoopB	Inst, Pfm1	Patch 20 (R5)	-
33	Hard Rock Backing	LoopB	Pfm1, 3	-	Pfm3:Gt50p. E
34	Blues Backing	LoopB	Pfm1, 2	Patch 19 (R9)	-
35	Jazz Backing	LoopB	Pfm1, 2	-	-
36	Samba Backing	LoopB	Pfm1, 2	-	Pfm2:VibeL. E
37	Salsa Backing	LoopB	Pfm1, 2, 3	-	-
38	Cha Cha Cha Backing	LoopB	Pfm1, 2, 3	-	-
39	Reggae Backing	LoopB	Pfm1, 2	-	-
40	Latin Unison	LoopB	Inst, Pfm1, 2	-	-
41	Bossa Nova Backing	LoopB	Pfm1, 2	-	Pfm2:VibeL. E
42	7Beat Backing	LoopB	Pfm1, 2, 3	-	-
43	Samba Pattern	Tap1A	Inst	Patch 24 (T2, 3, R2, 3)	-
44	Section	OnceB	Inst	Patch 22 (R4)	-
45	6 Stroke with Tom1	OnceA	Inst	Patch 21 (R4)	-
46	6 Stroke with Tom2	OnceA	Inst	Patch 21 (R5)	-
47	6 Stroke with Tom3	OnceA	Inst	Patch 21 (R6)	-
48	6 Stroke with Tom4	OnceA	Inst	Patch 21 (R7)	-

Standard kit (Patch 25) Note Map

Trigger	Note Name (Number)	Instrument (Sound1)
R1	B 1 (35)	15 Dry1. K (Kick 2)
T1	C 2 (36)	54 Pillw. K (Kick 1)
	C# 2 (37)	201 MplSt. S (Side Stick)
T2	D 2 (38)	138 LAFat. S (Snare 1)
R5	D# 2 (39)	426 80Clp. P (Hand Clap)
R2	E 2 (40)	169 Rea11. S (Snare 2)
T7	F 2 (41)	267 Rea14. T (Tom4)
	F# 2 (42)	300 AcoCl. H (Close Hi-hat)
	G 2 (43)	266 Rea13. T (Tom3)
PEDAL	G# 2 (44)	304 AcoPH. H (Pedal Hi-hat)
T6	A 2 (45)	266 Rea13. T (Tom3)
T3 R3	A# 2 (46)	302 AcoOl. H (Open Hi-hat)
	B 2 (47)	265 Rea12. T (Tom2)
T5	C 3 (48)	265 Rea12. T (Tom2)
T9	C# 3 (49)	326 Crsh3. C (Crash Cymbal)
T4	D 3 (50)	264 Rea11. T (Tom1)
T8	D# 3 (51)	332 Ride. C (Ride Cymbal)
R9	E 3 (52)	331 Chin2. C (China Cymbal)
R8	F 3 (53)	333 RidBl. C (Ride Bell)
	F# 3 (54)	342 Tambl. P (Tambourine)
R4	G 3 (55)	328 Spla1. C (Crash Cymbal)
R6	G# 3 (56)	340 CowH. P (Cowbell)
R7	A 3 (57)	327 Crsh4. C (Crash Cymbal)
	A# 3 (58)	367 Vibsl. P (Vibraslap)
	B 3 (59)	332 Ride. C (Ride Cymbal)
	C 4 (60)	353 BngHM. P (High Bongo)
	C# 4 (61)	356 BngLO. P (Low Bongo)
	D 4 (62)	357 CgHMT. P (Mute Conga)
	D# 4 (63)	359 CgHOp. P (High Conga)
	E 4 (64)	362 CgLOp. P (Low Conga)
	F 4 (65)	364 TimbH. P (Timbales)
	F# 4 (66)	365 TimbL. P (Timbales)
	G 4 (67)	379 AgogH. P (Agogo)
	G# 4 (68)	380 AgogL. P (Agogo)
	A 4 (69)	375 CabUp. P (Cabasa)
	A# 4 (70)	372 Mracs. P (Maracas)
	B 4 (71)	377 WhisS. P (ShortWhistle)
	C 5 (72)	378 WhisL. P (Long Whistle)
	C# 5 (73)	368 Gui1S. P (Short Guiro)
	D 5 (74)	369 Gui1L. P (Long Guiro)
	D# 5 (75)	366 Clave. P (Claves)
	E 5 (76)	351 WdBkH. P (Woodblock)
	F 5 (77)	352 WdBkL. P (Woodblock)
	F# 5 (78)	381 CuiMt. P (Mute Cuica)
	G 5 (79)	382 CuiOp. P (Open Cuica)
	G# 5 (80)	349 TriMt. P (Mute Triangl)
	A 5 (81)	350 TriOp. P (Open Triangl)
	A# 5 (82)	374 Shakr. P (808 Maracas)
	B 5 (83)	512 Off. E (-)
	C 6 (84)	512 Off. E (-)
	C# 6 (85)	344 Cast1. P (Castanets)
	D 6 (86)	387 SrdMt. P (Mute Surdo)
	D# 6 (87)	388 SrdOp. P (Open Surdo)
	E 6 (88)	358 CgHSl. P (CongaSlapHi)
	F 6 (89)	512 Off. E (-)
	F# 6 (90)	512 Off. E (-)
	G 6 (91)	383 PndMt. P (MutePandiero)
	G# 6 (92)	384 PndOp. P (OpenPandiero)
	A 6 (93)	512 Off. E (-)

4. Wavform List

No.	Display	Nuance	Wavform Name	No.	Display	Nuance	Wavform Name
1	01.K	○	acoustic maple kick	65	22.S	○	huge snare
2	02.K	○	acoustic kick	66	23.S	○	hyper snare
3	03.K	○	boing solid kick	67	24.S	○	L.A. snare
4	04.K	○	bright kick	68	25.S	○	L.A. fat snare
5	05.K	○	commercial acoustic kick	69	26.S	○	light maple snare
6	06.K	○	commercial bright kick	70	27.S	○	light snare 1
7	07.K	○	commercial kick	71	28.S	○	light snare 2
8	08.K	○	deep kick	72	29.S	○	loose snare
9	09.K	○	deep room kick	73	30.S	○	maple rock snare
10	10.K	○	dry kick	74	31.S	○	noise snare
11	11.K	○	easy kick	75	32.S	○	pandiero snare
12	12.K	○	easy pillow kick	76	33.S	○	power snare
13	13.K	○	flop kick	77	34.S	○	radio snare
14	14.K	○	hard kick	78	35.S	○	rocker snare
15	15.K	○	high Q 808 kick	79	36.S	○	rockin' snare
16	16.K	○	hybrid kick	80	37.S	○	rock light snare
17	17.K	○	light reverb kick	81	38.S	○	rock power snare
18	18.K	○	mondo reverb kick	82	39.S	○	rock rim shot snare
19	19.K	○	mondo kick	83	40.S	○	real snare 1
20	20.K	○	mondo deep kick	84	41.S	○	real snare 2
21	21.K	○	maple pillow kick	85	42.S	○	reggae snare 1
22	22.K	○	maple reverb kick	86	43.S	○	reggae snare 2
23	23.K	○	pillow kick	87	44.S	○	ring snare
24	24.K	○	punch kick	88	45.S	○	ring maple snare
25	25.K	○	rap kick	89	46.S	○	rock snare 1
26	26.K	○	real kick	90	47.S	○	rock snare 2
27	27.K	○	reverb kick	91	48.S	○	super combo snare
28	28.K	○	room kick 1	92	49.S	○	super light snare
29	29.K	○	room kick 2	93	50.S	○	super whack snare
30	30.K	○	smash kick	94	51.S	○	tight snare
31	31.K	○	solid kick	95	52.S	○	TR - 808 snare
32	32.K	○	surdo acoustic kick	96	53.S	○	TR - 909 snare
33	33.K	○	synthesizer kick	97	54.S	○	90's snare
34	34.K	○	tight kick	98	55.S	○	909 light snare
35	35.K	○	timpani pillow kick	99	56.S	×	Ambient side stick
36	36.K	○	tom kick	100	57.S	×	maple side stick
37	37.K	○	TR - 808 kick	101	58.S	×	metal side stick
38	38.K	○	TR - 909 kick	102	59.S	×	TR - 808 side stick
39	39.K	○	reverb solid kick	103	01.T	○	acoustic tom 1
40	40.K	○	verby kick	104	02.T	○	acoustic tom 2
41	41.K	○	TR - 909 acoustic kick	105	03.T	○	ambo tom 1
42	42.K	○	TR - 909 commercial kick	106	04.T	○	ambo tom 2
43	43.K	○	TR - 909 hard kick	107	05.T	○	boosh tom 1
44	01.S	○	acoustic rim shot snare	108	06.T	○	boosh tom 2
45	02.S	○	acoustic snare	109	07.T	○	brush tom 1
46	03.S	○	attack snare	110	08.T	○	brush tom 2
47	04.S	○	big shot snare	111	09.T	○	dry tom 1
48	05.S	×	brush roll snare 1	112	10.T	○	dry tom 2
49	06.S	○	brush roll snare 2	113	11.T	○	double head tom 1
50	07.S	○	brush slap snare 1	114	12.T	○	double head tom 2
51	08.S	○	brush slap snare 2	115	13.T	○	electronic tom 1
52	09.S	○	brush slap snare 3	116	14.T	○	electronic tom 2
53	10.S	○	brush swish snare	117	15.T	○	electronic tom 3
54	11.S	○	combo snare	118	16.T	○	electronic tom 4
55	12.S	○	cracker snare	119	17.T	○	light tom 1
56	13.S	○	dance snare	120	18.T	○	light tom 2
57	14.S	○	double ring snare	121	19.T	○	real tom 1
58	15.S	○	dopin' snare	122	20.T	○	real tom 2
59	16.S	○	fat snare	123	21.T	○	real tom 3
60	17.S	○	hard snare	124	22.T	○	real tom 4
61	18.S	○	house snare 1	125	23.T	○	rim tom 1
62	19.S	○	house snare 2	126	24.T	○	rim tom 2
63	20.S	○	house snare 3	127	25.T	○	ring tom 1
64	21.S	○	house dopin' snare	128	26.T	○	ring tom 2

No.	Display	Nuance	Wavform Name	No.	Display	Nuance	Wavform Name
129	27.T	○	rock tom 1	193	39.P	○	taiko
130	28.T	○	rock tom 2	194	40.P	○	tompani
131	29.T	○	rock tom 3	195	41.P	○	tim tim
132	30.T	○	rock tom 4	196	42.P	○	woody
133	31.T	○	room tom 1	197	43.P	×	DR - 55 claves
134	32.T	○	room tom 2	198	44.P	×	CR - 78 cowbell
135	33.T	○	room tom 3	199	45.P	×	CR - 78 metallic beat
136	34.T	○	room tom 4	200	46.P	×	CR - 78 tambourine
137	35.T	○	surdo tom	201	47.P	×	CR - 78 maracas
138	36.T	○	TR - 808 tom	202	48.P	○	TR - 808 conga
139	01.H	○	pop closed hi - hat	203	49.P	×	TR - 808 claves
140	02.H	○	pop open hi - hat	204	50.P	×	TR - 808 maracas
141	03.H	×	pop pedal closed hi - hat	205	51.P	×	TR - 808 hand clap
142	04.H	○	acoustic closed hi - hat	206	52.P	×	TR - 808 cowbell
143	05.H	○	acoustic open hi - hat	207	01.M	○	glockenspiel
144	06.H	×	acoustic pedal closed hi - hat	208	02.M	○	kalimba
145	07.H	○	TR - 808 closed hi - hat	209	03.M	○	marimba lower
146	08.H	○	TR - 808 open hi - hat	210	04.M	○	marimba upper
147	01.C	×	crash cymbal 1	211	05.M	○	steel drum
148	02.C	×	crash cymbal 2	212	06.M	○	vibraphone lower
149	03.C	×	splash cymbal	213	07.M	○	vibraphone upper
150	04.C	×	chinese cymbal	214	08.M	○	xylophone
151	05.C	×	hand cymbals	215	09.M	○	gamelan 1
152	06.C	○	ride cymbal	216	10.M	○	gamelan 2
153	07.C	○	ride bell cymbal	217	11.M	○	gamelan 3
154	08.C	○	brush ride cymbal	218	01.E	×	scratch push
155	01.P	×	cowbell	219	02.E	×	scratch pull
156	02.P	×	tambourine	220	03.E	×	high Q
157	03.P	×	castanets	221	04.E	×	snaps
158	04.P	○	concert bass drum	222	05.E	×	hoo !
159	05.P	○	timpani	223	06.E	×	fx noise
160	06.P	×	triangle	224	07.E	×	reverb clap
161	07.P	×	wood block	225	08.E	○	light shot
162	08.P	○	bongo high	226	09.E	○	concert ambience
163	09.P	○	bongo low	227	10.E	○	crash !
164	10.P	○	conga high mute	228	11.E	○	dungeon
165	11.P	○	conga high slap	229	12.E	×	glass crash
166	12.P	○	conga high open	230	13.E	○	spark
167	13.P	○	conga low open	231	14.E	○	reverse kick
168	14.P	○	timbale high	232	15.E	○	reverse snare
169	15.P	○	timbale low	233	16.E	○	reverse tom
170	16.P	×	claves	234	17.E	×	reverse cymbal 1
171	17.P	×	vibra - slap	235	18.E	×	reverse cymbal 2
172	18.P	×	guiro short	236	19.E	×	reverse cymbal 3
173	19.P	×	guiro long	237	20.E	×	reverse high Q
174	20.P	×	maracas	238	21.E	×	reverse clap
175	21.P	×	shaker	239	22.E	×	reverse shot
176	22.P	×	cabasa	240	23.E	×	reverse beat
177	23.P	×	whistle short	241	24.E	×	reverse ambience
178	24.P	×	whistle long	242	25.E	×	kick ambience
179	25.P	×	agogo	243	26.E	×	snare ambience
180	26.P	×	cuica	244	27.E	×	tom ambience
181	27.P	×	pandiero mute	245	28.E	×	guitar hit
182	28.P	○	pandiero open	246	29.E	×	guitar 5th
183	29.P	○	surdo	247	30.E	×	orchestra hit
184	30.P	○	can 1	248	31.E	○	melodic 1
185	31.P	○	can 2	249	32.E	○	melodic 2
186	32.P	○	can 3	250	33.E	○	melodic 3
187	33.P	○	can 4	251	34.E	○	melodic 4
188	34.P	○	ethnic 1	252	01.B	○	jazz bass
189	35.P	○	ethnic 2	253	02.B	○	slap bass
190	36.P	○	ethnic 3	254	03.B	○	acoustic bass
191	37.P	○	log drum	255	04.B	○	synthesizer bass 1
192	38.P	○	metal	256	05.B	○	synthesizer bass 2

5. Instrument List (Initial Settings)

No.	Display	Instrument Name	No.	Display	Instrument Name
1	AcMpl.K	acoustic maple kick	65	Rubbr.K	rubber kick
2	Acous.K	acoustic kick	66	Sine.K	sine kick
3	BoSld.K	boing solid kick	67	Smash.K	smash kick
4	Bottm.K	bottom kick	68	Soft1.K	soft kick 1
5	Brite.K	bright kick	69	Soft2.K	soft kick 2
6	Catch.K	catch kick	70	Solid.K	solid kick
7	Chop.K	chop kick	71	SrdAc.K	surdo acoustic kick
8	Clay.K	clay kick	72	Stone.K	stone kick
9	CmAco.K	commercial acoustic kick	73	Syn1.K	synthesizer kick 1
10	CmBrt.K	commercial bright kick	74	Syn2.K	synthesizer kick 2
11	Comrc.K	commercial kick	75	Tight.K	tight kick
12	Deep.K	deep kick	76	TmPlw.K	timpani pillow kick
13	Dig.K	dig kick	77	Tom.K	tom kick
14	DpRom.K	deep room kick	78	TR808.K	TR - 808 kick
15	Dry1.K	dry kick 1	79	TR909.K	TR - 909 kick
16	Dry2.K	dry kick 2	80	Tube.K	tube kick
17	Dry3.K	dry kick 3	81	VbSld.K	reverb solid kick
18	Dry4.K	dry kick 4	82	Verby.K	verby kick
19	Elec1.K	electronic kick 1	83	Wild.K	wild kick
20	Elec2.K	electronic kick 2	84	Wood1.K	wood kick 1
21	Ez.K	easy kick	85	Wood2.K	wood kick 2
22	EzPlw.K	easy pillow kick	86	808Sf.K	808 soft kick
23	Face.K	face kick	87	909Ac.K	909 acoustic kick
24	Flick.K	flick kick	88	909Cm.K	909 commercial kick
25	Floor.K	floor kick	89	909Hd.K	909 hard kick
26	Flop.K	flop kick	90	Acous.S	acoustic snare
27	Full.K	full kick	91	AcoRm.S	acoustic rim shot snare
28	Gate1.K	gate kick 1	92	Atak1.S	attack snare 1
29	Gate2.K	gate kick 2	93	Atak2.S	attack snare 2
30	Grit.K	grit kick	94	Atak3.S	attack snare 3
31	Hard1.K	hard kick 1	95	Bambo.S	bamboo snare
32	Hard2.K	hard kick 2	96	BgSht.S	big shot snare
33	Heavy.K	heavy kick	97	Brass.S	brass snare
34	Hous1.K	house kick 1	98	BrRl1.S	brush roll snare 1
35	Hous2.K	house kick	99	BrRl2.S	brush roll snare 2
36	Hous3.K	house kick 3	100	BrRl3.S	brush roll snare 3
37	Huge.K	huge kick	101	BrSl1.S	brush slap snare 1
38	Hybrd.K	hybrid kick	102	BrSl2.S	brush slap snare 2
39	HQ808.K	high Q 808 kick	103	BrSl3.S	brush slap snare 3
40	Jazz.K	jazz kick	104	BrSl4.S	brush slap snare 4
41	Lite1.K	light kick 1	105	BrSl5.S	brush slap snare 5
42	Lite2.K	light kick 2	106	BrSl6.S	brush slap snare 6
43	Log.K	log kick	107	BrSw1.S	brush swish snare 1
44	LtVrb.K	light reverb kick	108	BrSw2.S	brush swish snare 2
45	Machi.K	machine kick	109	Cave.S	cave snare
46	Manuf.K	manufacture kick	110	Ceram.S	ceramic snare
47	MdVrb.K	mondo reverb kick	111	Chain.S	chain snare
48	Mondo.K	mondo kick	112	Clip.S	clip snare
49	MonDp.K	mondo deep kick	113	Comb1.S	combo snare 1
50	MpPlw.K	maple pillow kick	114	Comb2.S	combo snare 2
51	MpVrb.K	maple reverb kick	115	Crack.S	crack snare
52	Muffl.K	muffie kick	116	Crker.S	cracker snare
53	Muscl.K	muscle kick	117	Dance.S	dance snare
54	Pillw.K	pillow kick	118	DblRn.S	double ring snare
55	Pinch.K	pinch kick	119	Dk808.S	dark 808 snare
56	Punch.K	punch kick	120	Dopin.S	dopin' snare
57	Rap.K	rap kick	121	Drip.S	drip snare
58	Real.K	real kick	122	Explo.S	explosive snare
59	Reso1.K	resonant kick 1	123	Fat.S	fat snare
60	Reso2.K	resonant kick 2	124	Fiber.S	fiber snare
61	RevrB.K	reverb kick	125	Freez.S	freeze snare
62	Room1.K	room kick 1	126	Frozn.S	frozen snare
63	Room2.K	room kick 2	127	Hard.S	hard snare
64	Room3.K	room kick 3	128	Hous1.S	house snare 1

No.	Display	Instrument Name
129	Hous2.S	house snare 2
130	Hous3.S	house snare 3
131	HsDpn.S	house dopin' snare
132	Huge.S	huge snare
133	Hyper.S	hyper snare
134	Kerf.S	kerf snare
135	Kettl.S	kettle snare
136	LA.S	L.A. snare
137	Labo.S	labo snare
138	LAFat.S	L.A. fat snare
139	Lite1.S	light snare 1
140	Lite2.S	light snare 2
141	Lite3.S	light snare 3
142	Lo - Fi.S	lo - fi snare
143	Loos1.S	loose snare 1
144	Loos2.S	loose snare 2
145	LtMpl.S	light maple snare
146	Lt909.S	light 909 snare
147	Machi.S	machine snare
148	Megal.S	megalo snare
149	Memph.S	Memphis snare
150	Micro.S	micro snare
151	MpRck.S	maple rock snare
152	Noise.S	noise snare
153	Nshvl.S	Nashville snare
154	Paper.S	paper snare
155	Paris.S	Paris snare
156	Picc1.S	piccolo snare 1
157	Picc2.S	piccolo snare 2
158	Picc3.S	piccolo snare 3
159	Picc4.S	piccolo snare 4
160	Power.S	power snare
161	Powfl.S	powerful snare
162	Punch.S	punch snare
163	Radio.S	radio snare
164	Rcker.S	rocker snare
165	Rckin.S	rockin' snare
166	RckLt.S	rock light snare
167	RckPw.S	rock power snare
168	RckRm.S	rock rim shot snare
169	Real1.S	real snare 1
170	Real2.S	real snare 2
171	Real3.S	real snare 3
172	Real4.S	real snare 4
173	Real5.S	real snare 5
174	Regg1.S	reggae snare 1
175	Regg2.S	reggae snare 2
176	Regg3.S	reggae snare 3
177	Regg4.S	reggae snare 4
178	Ring.S	ring snare
179	RngMp.S	ring maple snare
180	Rock1.S	rock snare 1
181	Rock2.S	rock snare 2
182	Room1.S	room snare 1
183	Room2.S	room snare 2
184	SprCb.S	super combo snare
185	SprLt.S	super light snare
186	SprWk.S	super whack snare
187	Stead.S	steady snare
188	Tight.S	tight snare
189	Tin.S	tin snare
190	Toy.S	toy snare
191	TR808.S	TR - 808 snare
192	TR909.S	TR - 909 snare

No.	Display	Instrument Name
193	UltLt.S	ultra light snare
194	WdAtk.S	wood attack snare
195	WdSht.S	wood shot snare
196	90's.S	90's snare
197	909Lt.S	909 light snare
198	AmbSt.S	ambient side stick
199	DrySt.S	dry side stick
200	HicSt.S	hickory side stick
201	MplSt.S	maple side stick
202	MtlSt.S	metal side stick
203	808St.S	TR - 808 side stick
204	Acou1.T	acoustic tom 1
205	Acou2.T	acoustic tom 2
206	Acou3.T	acoustic tom 3
207	Acou4.T	acoustic tom 4
208	Ambo1.T	ambo tom 1
209	Ambo2.T	ambo tom 2
210	Ambo3.T	ambo tom 3
211	Ambo4.T	ambo tom 4
212	Bend1.T	bend tom 1
213	Bend2.T	bend tom 2
214	Bend3.T	bend tom 3
215	Bend4.T	bend tom 4
216	Boos1.T	boosh tom 1
217	Boos2.T	boosh tom 2
218	Boos3.T	boosh tom 3
219	Boos4.T	boosh tom 4
220	Brsh1.T	brush tom 1
221	Brsh2.T	brush tom 2
222	Brsh3.T	brush tom 3
223	Brsh4.T	brush tom 4
224	Dry1.T	dry tom 1
225	Dry2.T	dry tom 2
226	Dry3.T	dry tom 3
227	Dry4.T	dry tom 4
228	Dubl1.T	double head tom 1
229	Dubl2.T	double head tom 2
230	Dubl3.T	double head tom 3
231	Dubl4.T	double head tom 4
232	Elec1.T	electronic tom 1
233	Elec2.T	electronic tom 2
234	Elec3.T	electronic tom 3
235	Elec4.T	electronic tom 4
236	Flot1.T	float tom 1
237	Flot2.T	float tom 2
238	Flot3.T	float tom 3
239	Flot4.T	float tom 4
240	Grnd1.T	ground tom 1
241	Grnd2.T	ground tom 2
242	Grnd3.T	ground tom 3
243	Grnd4.T	ground tom 4
244	Lite1.T	light tom 1
245	Lite2.T	light tom 2
246	Lite3.T	light tom 3
247	Lite4.T	light tom 4
248	Map1.T	maple tom 1
249	Map2.T	maple tom 2
250	Map3.T	maple tom 3
251	Map4.T	maple tom 4
252	MBru1.T	mild brush tom 1
253	MBru2.T	mild brush tom 2
254	MBru3.T	mild brush tom 3
255	MBru4.T	mild brush tom 4
256	Milt1.T	mallet tom 1

No.	Display	Instrument Name
257	Mllt2.T	mallet tom 2
258	Mllt3.T	mallet tom 3
259	Mllt4.T	mallet tom 4
260	Quak1.T	quake tom 1
261	Quak2.T	quake tom 2
262	Quak3.T	quake tom 3
263	Quak4.T	quake tom 4
264	Real1.T	real tom 1
265	Real2.T	real tom 2
266	Real3.T	real tom 3
267	Real4.T	real tom 4
268	Rim1.T	rim tom 1
269	Rim2.T	rim tom 2
270	Rim3.T	rim tom 3
271	Rim4.T	rim tom 4
272	Ring1.T	ring tom 1
273	Ring2.T	ring tom 2
274	Ring3.T	ring tom 3
275	Ring4.T	ring tom 4
276	Rock1.T	rock tom 1
277	Rock2.T	rock tom 2
278	Rock3.T	rock tom 3
279	Rock4.T	rock tom 4
280	Room1.T	room tom 1
281	Room2.T	room tom 2
282	Room3.T	room tom 3
283	Room4.T	room tom 4
284	Side1.T	side tom 1
285	Side2.T	side tom 2
286	Side3.T	side tom 3
287	Side4.T	side tom 4
288	Surd1.T	surdo tom 1
289	Surd2.T	surdo tom 2
290	Surd3.T	surdo tom 3
291	Surd4.T	surdo tom 4
292	Tank1.T	tank tom 1
293	Tank2.T	tank tom 2
294	Tank3.T	tank tom 3
295	Tank4.T	tank tom 4
296	808 - 1.T	TR - 808 tom 1
297	808 - 2.T	TR - 808 tom 2
298	808 - 3.T	TR - 808 tom 3
299	808 - 4.T	TR - 808 tom 4
300	AcoCl.H	acoustic closed hi - hat inner
301	AcoCO.H	acoustic closed hi - hat outer
302	AcoOI.H	acoustic open hi - hat inner
303	AcoOO.H	acoustic open hi - hat outer
304	AcoPH.H	acoustic pedal closed hi - hat
305	HvyCH.H	heavy closed hi - hat
306	HvyOH.H	heavy open hi - hat
307	HvyPH.H	heavy pedal closed hi - hat
308	LaxCH.H	lax closed hi - hat
309	LaxOH.H	lax open hi - hat
310	LaxPH.H	lax pedal closed hi - hat
311	LitCH.H	light closed hi - hat
312	LitOH.H	light open hi - hat
313	LitPH.H	light pedal closed hi - hat
314	PopCH.H	pop closed hi - hat
315	PopOH.H	pop open hi - hat
316	PopPH.H	pop pedal closed hi - hat
317	StiCH.H	sting closed hi - hat
318	StiOH.H	sting open hi - hat
319	TipCH.H	tip closed hi - hat
320	TipOH.H	tip open hi - hat

No.	Display	Instrument Name
321	TipPH.H	tip pedal closed hi - hat
322	808CH.H	TR - 808 closed hi - hat
323	808OH.H	TR - 808 open hi - hat
324	Crsh1.C	crash cymbal 1
325	Crsh2.C	crash cymbal 2
326	Crsh3.C	crash cymbal 3
327	Crsh4.C	crash cymbal 4
328	Spla1.C	splash cymbal 1
329	Spla2.C	splash cymbal 2
330	Chin1.C	chinese cymbal 1
331	Chin2.C	chinese cymbal 2
332	Ride.C	ride cymbal
333	RidBl.C	ride bell cymbal
334	RRide.C	rock ride cymbal
335	RRdBl.C	rock ride bell cymbal
336	BrRid.C	brush ride cymbal
337	FeRid.C	feather ride cymbal
338	Hand1.C	hand cymbals 1
339	Hand2.C	hand cymbals 2
340	CowH.P	cowbell high
341	CowL.P	cowbell low
342	Tamb1.P	tambourine 1
343	Tamb2.P	tambourine 2
344	Cast1.P	castanets 1
345	Cast2.P	castanets 2
346	CnBDM.P	concert bass drum mute
347	CnBDO.P	concert bass drum open
348	Timpa.P	timpani
349	TriMt.P	triangle mute
350	TriOp.P	triangle open
351	WdBkH.P	wood block high
352	WdBkL.P	wood block low
353	BngHM.P	bongo high mute
354	BngHO.P	bongo high open
355	BngLM.P	bongo low mute
356	BngLO.P	bongo low open
357	CgHMT.P	conga high mute
358	CgHSI.P	conga high slap
359	CgHOp.P	conga high open
360	CgLMT.P	conga low mute
361	CgLSI.P	conga low slap
362	CgLOP.P	conga low open
363	Talk.P	talking drum
364	TimbH.P	timbale high
365	TimbL.P	timbale low
366	Clave.P	claves
367	Vibsl.P	vibra - slap
368	Gui1S.P	guiro 1 short
369	Gui1L.P	guiro 1 long
370	Gui2S.P	guiro 2 short
371	Gui2L.P	guiro 2 long
372	Mrcs.P	maracas
373	MtShk.P	metal shaker
374	Shakr.P	shaker
375	CabUp.P	cabasa up
376	CabDn.P	cabasa down
377	WhisS.P	whistle short
378	WhisL.P	whistle long
379	AgogH.P	agogo high
380	AgogL.P	agogo low
381	CuiMt.P	cuica mute
382	CuiOp.P	cuica open
383	PndMt.P	pandiero mute
384	PndOp.P	pandiero open

No.	Display	Instrument Name
385	LgPnd.P	large pandiero
386	SmPnd.P	small pandiero
387	SrdMt.P	surdo mute
388	SrdOp.P	surdo open
389	Caxix.P	caxixi
390	DjmbH.P	djembe high
391	DjmbL.P	djembe low
392	BellH.P	bell high
393	BellL.P	bell low
394	Can1.P	can 1
395	Can2.P	can 2
396	Can3.P	can 3
397	Can4.P	can 4
398	Can5.P	can 5
399	Ethn1.P	ethnic 1
400	Ethn2.P	ethnic 2
401	Ethn3.P	ethnic 3
402	Ethn4.P	ethnic 4
403	Ethn5.P	ethnic 5
404	Flex.P	flex
405	Met1.P	metal 1
406	Met2.P	metal 2
407	OpenH.P	open drum high
408	OpenL.P	open drum low
409	TaikH.P	taiko high
410	TaikL.P	taiko low
411	Templ.P	temple bell
412	TompH.P	tompani high
413	TompL.P	tompani low
414	Woody.P	woody
415	55Bik.P	DR - 55 block
416	55Clv.P	DR - 55 claves
417	78Cow.P	CR - 78 cowbell
418	78MBt.P	CR - 78 metallic beat
419	78Tmb.P	CR - 78 tambourine
420	78Mrc.P	CR - 78 maracas
421	80CgH.P	TR - 808 conga high
422	80CgM.P	TR - 808 conga mid
423	80CgL.P	TR - 808 conga low
424	80Clv.P	TR - 808 claves
425	80Mrc.P	TR - 808 maracas
426	80Cip.P	TR - 808 hand clap
427	80Cow.P	TR - 808 cowbell
428	Glock.M	glockenspiel
429	Kalim.M	kalimba
430	MariL.M	marimba lower
431	MariU.M	marimba upper
432	StlDr.M	steel drum
433	VibeL.M	vibraphone lower
434	VibeU.M	vibraphone upper
435	Xylop.M	xylophone
436	Game1.M	gamelan 1
437	Game2.M	gamelan 2
438	Game3.M	gamelan 3
439	Arc.E	arc
440	BigFt.E	big foot
441	BnSaw.E	bend saw
442	CnAmb.E	concert ambience
443	Crsh1.E	crash 1
444	Crsh2.E	crash 2
445	Drop.E	drop
446	Dungn.E	dungeon
447	Emerg.E	emergency
448	Flip.E	flip

No.	Display	Instrument Name
449	Glass.E	glass crash
450	Gun1.E	gun shot 1
451	Gun2.E	gun shot 2
452	Gun3.E	gun shot 3
453	Hammr.E	hammer
454	HiQ.E	high Q
455	Hoo!.E	hoo !
456	Iron.E	iron
457	Knock.E	knocker
458	LtSht.E	light shot
459	Nois1.E	noise 1
460	Nois2.E	noise 2
461	Nois3.E	noise 3
462	Pass.E	pass
463	Phase.E	phase
464	Pipe.E	pipe
465	Rand1.E	random 1
466	Rand2.E	random 2
467	Sciss.E	scissors
468	ScrPs.E	scratch push
469	ScrPl.E	scratch pull
470	Shut.E	shut
471	Snaps.E	snaps
472	Sonar.E	sonar
473	Spark.E	spark
474	Spray.E	spray
475	Squas.E	squash
476	Stone.E	stone
477	VbClp.E	reverb clap
478	Zoom.E	zoom
479	RevK.E	reverse kick
480	RevS.E	reverse snare
481	RevT.E	reverse tom
482	RevC1.E	reverse cymbal 1
483	RevC2.E	reverse cymbal 2
484	RevC3.E	reverse cymbal 3
485	RevHQ.E	reverse high Q
486	RevCp.E	reverse clap
487	RevSh.E	reverse shot
488	RevBt.E	reverse beat
489	RevAm.E	reverse ambience
490	KAmb1.E	kick ambience 1
491	KAmb2.E	kick ambience 2
492	SAmb1.E	snare ambience 1
493	SAmb2.E	snare ambience 2
494	TAmb1.E	tom ambience 1
495	TAmb2.E	tom ambience 2
496	TAmb3.E	tom ambience 3
497	TAmb4.E	tom ambience 4
498	OrHit.E	orchestra hit
499	GtHit.E	guitar hit
500	Gt5Mt.E	guitar 5th mute
501	Gt5Op.E	guitar 5th open
502	LogDr.E	log drum
503	Melo1.E	melodic 1
504	Melo2.E	melodic 2
505	Melo3.E	melodic 3
506	Melo4.E	melodic 4
507	Jazz.B	jazz bass
508	Slap.B	slap bass
509	Acous.B	acoustic bass
510	Syn1.B	synthesizer bass 1
511	Syn2.B	synthesizer bass 2
512	Off.E	off

6.Initial Settings

PATCH

Number	17	Name	August	Program Change No.	81
---------------	----	-------------	--------	---------------------------	----

EFFECT			
EFFECT 1 (Reverb)	Hall	Out Level	10
		Reverb Time	9
		Pre LPF	5
	Room	Out Level	10
		Reverb Time	5
		Pre LPF	8
	Plate	Out Level	10
		Reverb Time	5
		Pre LPF	0
	Delay	Out Level	10
Time R		200	
Time L		240	
Pre LPF		0	
Feedback		8	
EFFECT 2	Chorus	Out Level	10
		Rate	12
		Depth	10
	Flanger	Out Level	10
		Rate	12
		Feedback	4
		Depth	10
	Delay Time	15	

PERFORMANCE SOUND		
PFM1	508	Slap. B
PFM2	443	VibeL. M
PFM3	501	Gt50p. E

NOTE								
NOTE No.	SOUND 1			SOUND 2			LAYER	
	INST	PITCH	PITCH	INST	PITCH	PITCH	TYPE	VALUE
35	15 Dry1. K	+0		512 Off. E	+0		OFF	
36	61 Reverb. K	+0		512 Off. E	+0		OFF	
37	201 Mp1St. S	+0		512 Off. E	+0		OFF	
38	126 Frozn. S	+0		512 Off. E	+0		OFF	
39	477 VbClp. E	+0		512 Off. E	+0		OFF	
40	122 Explo. S	+0		512 Off. E	+0		OFF	
41	263 Quak4. T	+0		263 Quak4. T	+0		MIX	5
42	314 PopCH. H	+0		512 Off. E	+0		OFF	
43	266 Real3. T	+0		512 Off. E	+0		OFF	
44	307 HvyPH. H	+0		512 Off. E	+0		OFF	
45	262 Quak3. T	+0		262 Quak3. T	+0		MIX	5
46	306 HvyOH. H	+0		305 HvyCH. H	+0		OFF	
47	265 Real2. T	+0		512 Off. E	+0		OFF	
48	261 Quak2. T	+0		261 Quak2. T	+0		MIX	5
49	326 Crsh3. C	-100		326 Crsh3. C	+0		SW 1	7
50	260 Quak1. T	+0		260 Quak1. T	+0		MIX	5
51	332 Ride. C	+0		334 RRide. C	+0		CROSS1	7
52	331 Chin2. C	+100		331 Chin2. C	+200		SW 1	7
53	333 RidBl. C	+0		335 RRdBl. C	+0		MIX	7
54	342 Tamb1. P	+0		512 Off. E	+0		OFF	
55	444 Crsh2. E	+0		512 Off. E	+0		OFF	
56	340 CowH. P	+0		512 Off. E	+100		OFF	
57	327 Crsh4. C	+200		324 Crsh1. C	+200		MIX	4
58	367 Vibsl. P	+0		512 Off. E	+0		OFF	
59	332 Ride. C	+0		512 Off. E	+0		OFF	
60	353 BngHM. P	+0		512 Off. E	+0		OFF	
61	356 BngLO. P	+0		512 Off. E	+0		OFF	
62	357 CgHMt. P	+0		512 Off. E	+0		OFF	
63	359 CgHOp. P	+0		512 Off. E	+0		OFF	
64	362 CgLOp. P	+0		512 Off. E	+0		OFF	
65	364 TimbH. P	+0		512 Off. E	+0		OFF	
66	365 TimbL. P	+0		512 Off. E	+0		OFF	
67	379 AgogH. P	+0		512 Off. E	+0		OFF	
68	380 AgogL. P	+0		512 Off. E	+0		OFF	
69	375 CabUp. P	+0		512 Off. E	+0		OFF	
70	372 Mracs. P	+0		512 Off. E	+0		OFF	
71	377 WhisS. P	+0		512 Off. E	+0		OFF	
72	378 WhisL. P	+0		512 Off. E	+0		OFF	
73	368 Gui1S. P	+0		512 Off. E	+0		OFF	
74	369 Gui1L. P	+0		512 Off. E	+0		OFF	
75	366 Clave. P	+0		512 Off. E	+0		OFF	
76	351 WdBkH. P	+0		512 Off. E	+0		OFF	
77	352 WdBkL. P	+0		512 Off. E	+0		OFF	
78	381 CuiMt. P	+0		512 Off. E	+0		OFF	
79	382 CuiOp. P	+0		512 Off. E	+0		OFF	
80	349 TriMt. P	+0		512 Off. E	+0		OFF	
81	350 TriOp. P	+0		512 Off. E	+0		OFF	
82	374 Shakr. P	+0		512 Off. E	+0		OFF	
83	512 Off. E	+0		512 Off. E	+0		OFF	
84	512 Off. E	+0		512 Off. E	+0		OFF	
85	344 Cast1. P	+0		512 Off. E	+0		OFF	
86	387 SrdMt. P	+0		512 Off. E	+0		OFF	
87	388 SrdOp. P	+0		512 Off. E	+0		OFF	
88	358 CgHSl. P	+0		512 Off. E	+0		OFF	
89	512 Off. E	+0		512 Off. E	+0		OFF	
90	512 Off. E	+0		512 Off. E	+0		OFF	
91	383 PndMt. P	+0		512 Off. E	+0		OFF	
92	384 PndOp. P	+0		512 Off. E	+0		OFF	
93	309 LaxOH. H	+0		308 LaxCH. H	+0		OFF	

TRIGGER

Trigger Name	Note No.	Gate Time	Cross Talk Cancel Group	Velocity Sense Curve	Seq. Pattern No.	Choke	Max Dynamic	Minimum Dinamic	Minimum Velocity	Mask Time	Threshold Level
T1	36	0.1	OFF	Norm3	OFF	OFF	8	1	1	52ms	8
R1	35	0.1	OFF	Norm3	OFF	OFF	8	1	1	52ms	8
T2	38	0.1	OFF	Norm3	OFF	OFF	11	1	1	0ms	8
R2	40	0.1	OFF	Norm3	OFF	OFF	11	1	1	0ms	8
T3	46	0.1	OFF	Norm4	OFF	ON	11	1	1	0ms	8
R3	93	0.1	OFF	Norm4	OFF	ON	11	1	1	0ms	8
T4	50	0.1	OFF	Norm3	OFF	OFF	11	1	1	0ms	8
R4	55	0.1	OFF	Norm3	OFF	ON	11	1	1	0ms	8
T5	48	0.1	OFF	Norm3	OFF	OFF	11	1	1	0ms	8
R5	39	0.1	OFF	Norm3	OFF	OFF	11	1	1	0ms	8
T6	45	0.1	OFF	Norm3	OFF	OFF	11	1	1	0ms	8
R6	56	0.1	OFF	Norm3	OFF	OFF	11	1	1	0ms	8
T7	41	0.1	OFF	Norm3	OFF	OFF	11	1	1	0ms	8
R7	57	0.1	OFF	Norm3	OFF	ON	11	1	1	0ms	8
T8	51	0.1	OFF	Norm3	OFF	ON	11	1	1	0ms	8
R8	53	0.1	OFF	Norm3	OFF	ON	11	1	1	0ms	8
T9	49	0.1	OFF	Norm3	OFF	ON	11	1	1	0ms	8
R9	52	0.1	OFF	Norm3	OFF	ON	11	1	1	0ms	8

Hi-Hat CONTROL PEDAL

Assign	TRIG3	Gate Time	0.1s
Control Mode	HiHat1	Velocity Sense Curve	Norm3
Pedal Curve	2	Sequence Pattern Number	OFF
Note Number	44		

■ GLOBAL PERFORMANCE

		PFM1	PFM2	PFM3
Key Range	Low Note	35 : B1	35 : B1	35 : B1
	HI Note	93 : A6	93 : A6	93 : A6
Control Change Mode		OFF	OFF	OFF
Performance Section Level		13	13	13
Keyfollow	Reference Note Number	60 : C4	60 : C4	60 : C4
	Pitch	+ 100	+ 100	+ 100
	Decay	± 0	± 0	± 0
	Nuance	± 0	± 0	± 0
	Pan	± 0	± 0	± 0

INSTRUMENT

	Number : 61	Number : 126	Number : 260	Number : 261
Name	RevrB.K	Frozn.S	Quak1.T	Quak2.T
Waveform	27.K	54.S	05.T	05.T
Pitch	+ 0	- 480	+ 500	+ 200
Decay	- 15	+ 12	+ 10	+ 10
Panning	C	C	L 6	L 2
Nuance	+ 3	- 2	+ 0	+ 0
Brilliance	0	10	0	0
Attack Damp	0	0	0	0
Dynamic Pitch Bend	+ 0	+ 0	- 7	- 7
Pitch Bend Time	0	0	16	17
Polyphony	Poly	Poly	Poly	Poly
Assign Group	OFF	OFF	OFF	OFF
Out Level	15	13	10	10
Send 1 Level	7	5	5	5
Send 2 Level	0	0	0	0

	Number : 305	Number : 306	Number : 326	Number : 332
Name	HvyCH.H	HvyOH.H	Crsh3.C	Ride.C
Waveform	04.H	05.H	01.C	06.C
Pitch	- 150	- 150	+ 300	+ 0
Decay	- 10	+ 10	+ 14	+ 10
Panning	L 3	L 3	L 3	R 3
Nuance	- 2	- 6	+ 0	- 2
Brilliance	8	8	7	5
Attack Damp	0	0	0	0
Dynamic Pitch Bend	+ 0	+ 0	+ 0	+ 0
Pitch Bend Time	0	0	0	0
Polyphony	Poly	Poly	Poly	Poly
Assign Group	Exc 1	Exc 1	OFF	OFF
Out Level	13	8	8	15
Send 1 Level	5	3	5	5
Send 2 Level	0	0	0	0

SYSTEM

MIDI	Trigger Transmit Channel	10	
	Transmit Receive Channel	Instrument Section	10
		Performance Section 1	11
		Performance Section 2	12
		Performance Section 3	13
		Patch Control	10
	Device ID	17	
	Switch	MIDI IN	ON
		MIDI OUT	ON
		MIDI MIX	OFF
		Note Off Receive	OFF
		Aftertouch Transmit Receive	ON
		Program Change Transmit	ON
		Program Change Receive	ON
		Hold Receive	OFF
		Pan Receive	OFF
		Volume Receive	OFF
		Local Control	ON
		System Exclusive Receive	ON
Instrument Section Level	15		
Pitch Bend	OFF		
Control Change	FOOT		

Interface Mode		STANDARD
Footswitch Mode		Mode 1
LCD Contrast		9
Sound Setup	Send1	EFFECT 1
	Send2	EFFECT 2

7. Blank Chart

■ PATCH

Number	Name	Program Change No.
--------	------	--------------------

EFFECT		
EFFECT 1 (Reverb)	Hall	Out Level
		Reverb Time
		Pre LPF
	Room	Out Level
		Reverb Time
		Pre LPF
	Plate	Out Level
		Reverb Time
		Pre LPF
Delay	Out Level	
	Time R	
	Time L	
	Pre LPF	
	Feedback	
EFFECT 2	Chorus	Out Level
		Rate
		Depth
	Flanger	Out Level
		Rate
		Feedback
Depth		
	Delay Time	

NOTE						
NOTE No.	SOUND 1		SOUND 2		LAYER	
	INST	PITCH	INST	PITCH	TYPE	VALUE
35						
36						
37						
38						
39						
40						
41						
42						
43						
44						
45						
46						
47						
48						
49						
50						
51						
52						
53						
54						
55						
56						
57						
58						
59						
60						
61						
62						
63						
64						
65						
66						
67						
68						
69						
70						
71						
72						
73						
74						
75						
76						
77						
78						
79						
80						
81						
82						
83						
84						
85						
86						
87						
88						
89						
90						
91						
92						
93						

PERFORMANCE SOUND	
PFM1	
PFM2	
PFM3	

TRIGGER

Trigger Name	Note No.	Gate Time	Cross Talk Cancel Group	Velocity Sense Curve	Seq Pattern No.	Choke	Max Dynamic	Minimum Dynamic	Minimum Velocity	Mask Time	Threshold Level
T1											
R1											
T2											
R2											
T3											
R3											
T4											
R4											
T5											
R5											
T6											
R6											
T7											
R7											
T8											
R8											
T9											
R9											

Hi-Hat CONTROL PEDAL

Assign		Gate Time	
Control Mode		Velocity Sense Curve	
Pedal Curve		Sequence Pattern Number	
Note Number			

■ GLOBAL PERFORMANCE

		PFM1	PFM2	PFM3
Key Range	Low Note			
	HI Note			
Control Change Mode				
Performance Section Level				
Keyfollow	Reference Note Number			
	Pitch			
	Decay			
	Nuance			
	Pan			

■ INSTRUMENT

	Number :	Number :	Number :	Number :
Name				
Waveform				
Pitch				
Decay				
Panning				
Nuance				
Brilliance				
Attack Damp				
Dynamic Pitch Bend				
Pitch Bend Time				
Polyphony				
Assign Group				
Out Level				
Send 1 Level				
Send 2 Level				

	Number :	Number :	Number :	Number :
Name				
Waveform				
Pitch				
Decay				
Panning				
Nuance				
Brilliance				
Attack Damp				
Dynamic Pitch Bend				
Pitch Bend Time				
Polyphony				
Assign Group				
Out Level				
Send 1 Level				
Send 2 Level				

■ SYSTEM

MIDI	Trigger Transmit Channel		
	Transmit Receive Channel	Instrument Section	
		Performance Section 1	
		Performance Section 2	
		Performance Section 3	
		Patch Control	
	Device ID		
	Switch	MIDI IN	
		MIDI OUT	
		MIDI MIX	
		Note Off Receive	
		Aftertouch Transmit Receive	
		Program Change Transmit	
		Program Change Receive	
		Hold Receive	
		Pan Receive	
		Volume Receive	
	Local Control		
System Exclusive Receive			
Instrument Section Level			
Pitch Bend			
Control Change			

Interface Mode		
Footswitch Mode		
LCD Contrast		
Sound Setup	Send1	
	Send2	

Roland Exclusive Messages

1 Data Format for Exclusive Messages

Roland's MIDI implementation uses the following data format for all exclusive messages (type IV):

Byte	Description
FOH	Exclusive status
41H	Manufacturer ID (Roland)
DEV	Device ID
MDL	Model ID
CMD	Command ID
[BODY]	Main data
F7H	End of exclusive

= MIDI status : FOH, F7H

An exclusive message must be flanked by a pair of status codes, starting with a Manufacturer-ID immediately after FOH (MIDI version 1.0).

= Manufacturer ID : 41H

The Manufacturer ID identifies the manufacturer of a MIDI instrument that triggers an exclusive message. Value 41H represents Roland's Manufacturer-ID.

= Device ID : DEV

The Device-ID contains a unique value that identifies the individual device in the multiple implementation of MIDI instruments. It is usually set to 00H - 0FH, a value smaller by one than that of a basic channel, but value 00H - 1FH may be used for a device with multiple basic channels.

= Model ID : MDL

The Model-ID contains a value that uniquely identifies one model from another. Different models, however, may share an identical Model ID if they handle similar data.

The Model ID format may contain 00H in one or more places to provide an extended data field. The following are examples of valid Model IDs, each representing a unique model:

01H
02H
03H
00H, 01H
00H, 02H
00H, 00H, 01H

= Command ID : CMD

The Command ID indicates the function of an exclusive message. The Command ID format may contain 00H in one or more places to provide an extended data field. The following are examples of valid Command IDs, each representing a unique function:

01H
02H
03H
00H, 01H
00H, 02H
00H, 00H, 01H

= Main data : BODY

This field contains a message to be exchanged across an interface. The exact data size and contents will vary with the Model-ID and Command-ID.

2 Address-mapped Data Transfer

Address mapping is a technique for transferring messages conforming to the data format given in Section 1. It assigns a series of memory-resident records-waveform and tone data, switch status, and parameters, for example-to specific locations in a machine-dependent address space, thereby allowing access to data residing at the address a message specifies.

Address-mapped data transfer is therefore independent of models and data categories. This technique allows use of two different transfer procedures: one way transfer and handshake transfer.

= One way transfer procedure (See Section 3 for details.)

This procedure is suited for the transfer of a small amount of data. It sends out an exclusive message completely independent of a receiving device status.

Connection Diagram

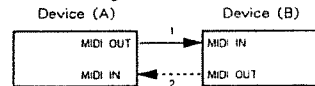

Connection at point 2 is essential for "Request data" procedures. (See Section 3.)

= Handshake transfer procedure (This device does not cover this procedure)

This procedure initiates a predetermined transfer sequence (handshaking) across the interface before data transfer takes place. Handshaking ensures that reliability and transfer speed are high enough to handle a large amount of data.

Connection Diagram

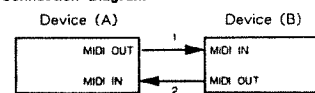

Connection at points 1 and 2 is essential.

Notes on the above two procedures

- * There are separate Command IDs for different transfer procedures.
- * Devices A and B cannot exchange data unless they use the same transfer procedure, share identical Device ID and Model ID, and are ready for communication.

3 One way Transfer Procedure

This procedure sends out data all the way until it stops and is used when the messages are so short that answerbacks need not be checked. For long messages, however, the receiving device must acquire each message in time with the transfer sequence, which inserts intervals of at least 20 milliseconds in between.

Types of Messages

Message	Command ID
Request data 1	RQ1 (11H)
Data set 1	DT1 (12H)

= Request data = 1 : RQ1 (11H)

This message is sent out when there is a need to acquire data from a device at the other end of the interface. It contains data for the address and size that specify designation and length, respectively, of data required.

On receiving an RQ1 message, the remote device checks its memory for the data address and size that satisfy the request.

If it finds them and is ready for communication, the device will transmit a "Data set 1 (DT1)" message, which contains the requested data. Otherwise, the device will send out nothing.

Byte	Description
FOH	Exclusive status
41H	Manufacturer ID (Roland)
DEV	Device ID
MDL	Model ID
11H	Command ID
aaH	Address MSB
⋮	⋮
⋮	⋮
⋮	LSB
ssH	Size MSB
⋮	⋮
⋮	⋮
⋮	LSB
sum	Check sum
F7H	End of exclusive

- * The size of the requested data does not indicate the number of bytes that will make up a DT1 message, but represents the address fields where the requested data resides.
- * Some models are subject to limitations in data format used for a single transaction. Requested data, for example, may have a limit in length or must be divided into predetermined address fields before it is exchanged across the interface.
- * The same number of bytes comprises address and size data, which, however, vary with the Model ID.
- * The error checking process uses a checksum that provides a bit pattern where the least significant 7 bits are zero when values for an address, size, and that checksum are summed.

= Data set 1 : DT1 (12H)

This message corresponds to the actual data transfer process. Because every byte in the data is assigned a unique address, a DT1 message can convey the starting address of one or more data as well as a series of data formatted in an address dependent order.

The MIDI standards inhibit non-real time messages from interrupting an exclusive one. This fact is inconvenient for the devices that support a "soft through" mechanism. To maintain compatibility with such devices, Roland has limited the DT1 to 256 bytes so that an excessively long message is sent out in separate segments.

Byte	Description
F0H	Exclusive
41H	Manufacturer ID (Roland)
DEV	Device ID
MDL	Model ID
12H	Command ID
aaH	Address MSB
⋮	⋮
	LSB
ddH	Data
⋮	⋮
sum	Check sum
F7H	End of exclusive

- * A DT1 message is capable of providing only the valid data among those specified by an RQ1 message.
- * Some models are subject to limitations in data format used for a single transaction. Requested data, for example, may have a limit in length or must be divided into predetermined address fields before it is exchanged across the interface.
- * The number of bytes comprising address data varies from one Model ID to another.
- * The error checking process uses a checksum that provides a bit pattern where the least significant 7 bits are zero when values for an address, size, and that checksum are summed.

= Example of Message Transactions

- Device A sending data to Device B
Transfer of a DT1 message is all that takes place.

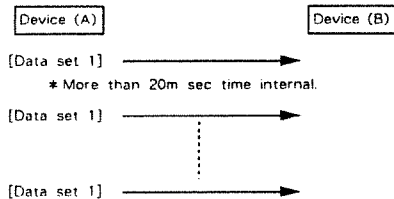

- Device B requesting data from Device A
Device B sends an RQ1 message to Device A. Checking the message, Device A sends a DT1 message back to Device B.

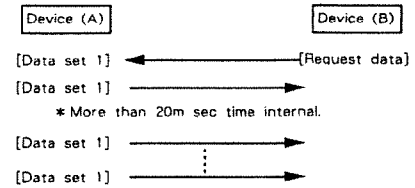

1. TRANSMITTED DATA

■ Channel Voice Message

● Note Off

Status	Second	Third
9nH	kkH	00H

n = MIDI channel : 0H - FH (ch.1 - ch.16)
 kk = Note number : 23H - 5DH (35 - 93)

● Note On

Status	Second	Third
9nH	kkH	vvH

n = MIDI channel : 0H - FH (ch.1 - ch.16)
 kk = Note number : 23H - 5DH (35 - 93)
 vv = Velocity : 01H - 7FH (1 - 127)

The TD-7 transmits at channel of each section.

The period between a Note On and the subsequent Note Off is about 10ms at the Phrase sequencer and is the time set to "Gate Time" of the TRIG section. If another note is made on the TRIG section before the Note Off for the previous note is issued, a Note Off for the previous note precedes the new Note On.

● Polyphonic Key Pressure

Status	Second	Third
AnH	kkH	vvH

n = MIDI channel : 0H - FH (ch.1 - ch.16)
 kk = Note number : 23H - 5DH (35 - 93)
 vv = Value : 00H, 7FH (0, 127)

Transmitted if the "choke" of the TRIG parameter assigned to head/rim of each pad is set at ON. This message is transmitted with value 7FH when the rim of the pad is grabbed or with value 00H when the rim is released.

Note number to be transferred is contained in the head/rim of the grabbed pad. When TRIG is set to the same number as Assign of the Pedal parameter and "CtrlMode" is set at HiHat1, the note number of the Hi-hat Control Pedal can be transferred.

When "CtrlMode" is set to HiHat2 instead of HiHat1, the note number of the head, rim, and note number of head minus 4, note number of rim minus 4 and note number of the Hi-hat Control Pedal are transferred.

● Control Change

○ Modulation Depth

Status	Second	Third
BnH	01H	vvH

○ Foot Type

Status	Second	Third
BnH	04H	vvH

○ General Purpose Controller - 1

Status	Second	Third
BnH	10H	vvH

○ General Purpose Controller - 2

Status	Second	Third
BnH	11H	vvH

n = MIDI channel : 0H - 0FH (ch.1 - ch.16)
 vv = Parameter value : 00H - 7FH (0 - 127)

The TD-7 transmits a value corresponding to the position of the Hi-hat Control Pedal by one of above control messages set at the "Ctrl Chg" of the MIDI parameter.

○ Hold1

Status	Second	Third
BnH	40H	vvH

n = MIDI channel : 0H - 0FH (ch.1 - ch.16)
 vv = Parameter value : 00H - 7FH (0 - 127)

The TD-7 transmits a value corresponding to the position of a Hi-hat Control Pedal by one of the above control messages set at the "Ctrl Chg" of the MIDI parameter.

Transmit vv = 7FH when footswitch 2 is pressed and vv = 00H when footswitch 2 is pressed if "mode" of Footswitch mode of System is set to "Mode 2."

● Program Change

Status	Second
CnH	ppH

n = MIDI channel : 0H - FH (ch.1 - ch.16)
 pp = Program number : 00H - 7FH (prog.1 - prog.128)

Transmitted if the "Prg Chg Tx" of the MIDI parameter is set at ON. The TD-7 transmits this message on the channel set at "Ctrl Ch" when the patch is changed.

■ System Exclusive Message

Status
F0H : System Exclusive
F7H : EOX (End Of Exclusive)

With the TD-7, the System Exclusive Messages can be used to transmit Bulk Dump of patch data, instrument data, system data, chain data and sequence data. For details refer to "3. Exclusive Communications" and "Roland Exclusive Messages."

■ System Real Time Message

● Timing clock

Status
F8H

When the sync mode is set at INTERNAL, the TD-7 always transmits timing clocks and when the sync mode is set at MIDI, the TD-7 never transmits timing clocks.

● Active Sensing

Status
FEH

Transmitted for checking MIDI connections between the TD-7 and external equipment.

2. RECOGNIZED RECEIVE DATA

2.1 Instrument section and Performance section 1 - 3

■ Channel Voice Message

● Note Off

Status	Second	Third
9nH	kkH	00H
8nH	kkH	vvH

n = MIDI channel : 0H - FH (ch.1 - ch.16)
 kk = Note number : 23H - 5DH (35 - 93)
 vv = Velocity : 00H - 7FH (0 - 127)

The TD-7 receives the messages on the channel of each section.

Note Off messages are ignored if the "NoteOff Rx" of MIDI parameter is set at OFF. Note Off messages are not recorded in the Phrase Sequencer. The Velocity is always ignored.

■ INSTRUMENT

	Number :	Number :	Number :	Number :
Name				
Waveform				
Pitch				
Decay				
Panning				
Nuance				
Brilliance				
Attack Damp				
Dynamic Pitch Bend				
Pitch Bend Time				
Polyphony				
Assign Group				
Out Level				
Send 1 Level				
Send 2 Level				

	Number :	Number :	Number :	Number :
Name				
Waveform				
Pitch				
Decay				
Panning				
Nuance				
Brilliance				
Attack Damp				
Dynamic Pitch Bend				
Pitch Bend Time				
Polyphony				
Assign Group				
Out Level				
Send 1 Level				
Send 2 Level				

■ SYSTEM

MIDI	Trigger Transmit Channel		
	Transmit Receive Channel	Instrument Section	
		Performance Section 1	
		Performance Section 2	
		Performance Section 3	
		Patch Control	
	Device ID		
	Switch	MIDI IN	
		MIDI OUT	
		MIDI MIX	
		Note Off Receive	
		Aftertouch Transmit Receive	
		Program Change Transmit	
		Program Change Receive	
		Hold Receive	
Pan Receive			
Volume Receive			
Local Control			
System Exclusive Receive			
Instrument Section Level			
Pitch Bend			
Control Change			

Interface Mode		
Footswitch Mode		
LCD Contrast		
Sound Setup	Send1	
	Send2	

Roland Exclusive Messages

1 Data Format for Exclusive Messages

Roland's MIDI implementation uses the following data format for all exclusive messages (type IV):

Byte	Description
F0H	Exclusive status
41H	Manufacturer ID (Roland)
DEV	Device ID
MDL	Model ID
CMD	Command ID
[BODY]	Main data
F7H	End of exclusive

= MIDI status : F0H, F7H

An exclusive message must be flanked by a pair of status codes, starting with a Manufacturer ID immediately after F0H (MIDI version 1.0).

= Manufacturer ID : 41H

The Manufacturer ID identifies the manufacturer of a MIDI instrument that triggers an exclusive message. Value 41H represents Roland's Manufacturer ID.

= Device ID : DEV

The Device ID contains a unique value that identifies the individual device in the multiple implementation of MIDI instruments. It is usually set to 00H - 0FH, a value smaller by one than that of a basic channel, but value 00H - 1FH may be used for a device with multiple basic channels.

= Model ID : MDL

The Model ID contains a value that uniquely identifies one model from another. Different models, however, may share an identical Model ID if they handle similar data.

The Model ID format may contain 00H in one or more places to provide an extended data field. The following are examples of valid Model IDs, each representing a unique model:

01H
02H
03H
00H, 01H
00H, 02H
00H, 00H, 01H

= Command ID : CMD

The Command ID indicates the function of an exclusive message. The Command ID format may contain 00H in one or more places to provide an extended data field. The following are examples of valid Command IDs, each representing a unique function:

01H
02H
03H
00H, 01H
00H, 02H
00H, 00H, 01H

= Main data : BODY

This field contains a message to be exchanged across an interface. The exact data size and contents will vary with the Model ID and Command ID.

2 Address-mapped Data Transfer

Address mapping is a technique for transferring messages conforming to the data format given in Section 1. It assigns a series of memory-resident records-waveform and tone data, switch status, and parameters, for example-to specific locations in a machine-dependent address space, thereby allowing access to data residing at the address a message specifies.

Address mapped data transfer is therefore independent of models and data categories. This technique allows use of two different transfer procedures: one-way transfer and handshake transfer.

= One way transfer procedure (See Section 3 for details.)

This procedure is suited for the transfer of a small amount of data. It sends out an exclusive message completely independent of a receiving device status.

Connection Diagram

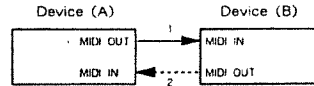

Connection at point 2 is essential for "Request data" procedures. (See Section 3.)

= Handshake transfer procedure (This device does not cover this procedure)

This procedure initiates a predetermined transfer sequence (handshaking) across the interface before data transfer takes place. Handshaking ensures that reliability and transfer speed are high enough to handle a large amount of data.

Connection Diagram

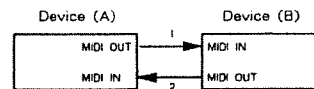

Connection at points 1 and 2 is essential.

Notes on the above two procedures

- * There are separate Command IDs for different transfer procedures.
- * Devices A and B cannot exchange data unless they use the same transfer procedure, share identical Device ID and Model ID, and are ready for communication.

3 One way Transfer Procedure

This procedure sends out data all the way until it stops and is used when the messages are so short that answerbacks need not be checked. For long messages, however, the receiving device must acquire each message in time with the transfer sequence, which inserts intervals of at least 20 milliseconds in between.

Types of Messages

Message	Command ID
Request data 1	RQ1 (11H)
Data set 1	DT1 (12H)

= Request data = 1 : RQ1 (11H)

This message is sent out when there is a need to acquire data from a device at the other end of the interface. It contains data for the address and size that specify designation and length, respectively, of data required.

On receiving an RQ1 message, the remote device checks its memory for the data address and size that satisfy the request.

If it finds them and is ready for communication, the device will transmit a "Data set 1 (DT1)" message, which contains the requested data. Otherwise, the device will send out nothing.

Byte	Description
F0H	Exclusive status
41H	Manufacturer ID (Roland)
DEV	Device ID
MDL	Model ID
11H	Command ID
aaH	Address MSB
⋮	⋮
⋮	LSB
ssH	Size MSB
⋮	⋮
⋮	LSB
sum	Check sum
F7H	End of exclusive

1. TRANSMITTED DATA

■ Channel Voice Message

● Note Off

Status	Second	Third
9nH	kkH	00H

n = MIDI channel : 0H - FH (ch.1 - ch.16)
 kk = Note number : 23H - 5DH (35 - 93)

● Note On

Status	Second	Third
9nH	kkH	vvH

n = MIDI channel : 0H - FH (ch.1 - ch.16)
 kk = Note number : 23H - 5DH (35 - 93)
 vv = Velocity : 01H - 7FH (1 - 127)

The TD-7 transmits at channel of each section.

The period between a Note On and the subsequent Note Off is about 10mS at the Phrase sequencer and is the time set to "Gate Time" of the TRIG section. If another note is made on the TRIG section before the Note Off for the previous note is issued, a Note Off for the previous note precedes the new Note On.

● Polyphonic Key Pressure

Status	Second	Third
AnH	kkH	vvH

n = MIDI channel : 0H - FH (ch.1 - ch.16)
 kk = Note number : 23H - 5DH (35 - 93)
 vv = Value : 00H, 7FH (0, 127)

Transmitted if the "choke" of the TRIG parameter assigned to head/rim of each pad is set at ON. This message is transmitted with value 7FH when the rim of the pad is grabbed or with value 00H when the rim is released.

Note number to be transferred is contained in the head/rim of the grabbed pad. When TRIG is set to the same number as Assign of the Pedal parameter and "CtrlMode" is set at Hihat1, the note number of the Hi-hat Control Pedal can be transferred.

When "CtrlMode" is set to Hihat2 instead of Hihat1, the note number of the head, rim, and note number of head minus 4, note number of rim minus 4 and note number of the Hi hat Control Pedal are transferred.

● Control Change

○ Modulation Depth

Status	Second	Third
BnH	01H	vvH

○ Foot Type

Status	Second	Third
BnH	04H	vvH

○ General Purpose Controller - 1

Status	Second	Third
BnH	10H	vvH

○ General Purpose Controller - 2

Status	Second	Third
BnH	11H	vvH

n = MIDI channel : 0H - 0FH (ch.1 - ch.16)
 vv = Parameter value : 00H - 7FH (0 - 127)

The TD-7 transmits a value corresponding to the position of the Hi-hat Control Pedal by one of above control messages set at the "Ctrl Chg" of the MIDI parameter.

○ Hold1

Status	Second	Third
BnH	40H	vvH

n = MIDI channel : 0H - 0FH (ch.1 - ch.16)
 vv = Parameter value : 00H - 7FH (0 - 127)

The TD-7 transmits a value corresponding to the position of a Hi-hat Control Pedal by one of the above control messages set at the "Ctrl Chg" of the MIDI parameter.

Transmit vv = 7FH when footswitch 2 is pressed and vv = 00H when footswitch 2 is pressed if "mode" of Footswitch mode of System is set to "Mode 2."

● Program Change

Status	Second
CnH	ppH

n = MIDI channel : 0H - FH (ch.1 - ch.16)
 pp = Program number : 00H - 7FH (prog.1 - prog.128)

Transmitted if the "Prg Chg Tx" of the MIDI parameter is set at ON. The TD-7 transmits this message on the channel set at "Ctrl Ch" when the patch is changed.

■ System Exclusive Message

Status
F0H : System Exclusive
F7H : EOX (End Of Exclusive)

With the TD-7, the System Exclusive Messages can be used to transmit Bulk Dump of patch data, instrument data, system data, chain data and sequence data. For details refer to "3. Exclusive Communications" and "Roland Exclusive Messages."

■ System Real Time Message

● Timing clock

Status
FBH

When the sync mode is set at INTERNAL, the TD-7 always transmits timing clocks and when the sync mode is set at MIDI, the TD-7 never transmits timing clocks.

● Active Sensing

Status
FEH

Transmitted for checking MIDI connections between the TD-7 and external equipment.

2. RECOGNIZED RECEIVE DATA

2.1 Instrument section and Performance section 1 - 3

■ Channel Voice Message

● Note Off

Status	Second	Third
9nH	kkH	00H
BnH	kkH	vvH

n = MIDI channel : 0H - FH (ch.1 - ch.16)
 kk = Note number : 23H - 5DH (35 - 93)
 vv = Velocity : 00H - 7FH (0 - 127)

The TD-7 receives the messages on the channel of each section.

Note Off messages are ignored if the "NoteOff Rx" of MIDI parameter is set at OFF. Note Off messages are not recorded in the Phrase Sequencer. The Velocity is always ignored.

● Note On

Status	Second	Third
9nH	kkH	vvH

n = MIDI channel : 0H - 0FH (ch.1 - ch.16)
 kk = Note number : 23H - 5DH (35 - 93)
 vv = Velocity : 01H - 7FH (1 - 127)

The TD 7 receives the message on the channel of each section.

Sounds the instrument assigned to the received note number of the current patch of the Instrument section. Sounds the instrument assigned to the Performance section in the range of Note number that is from the value of "Low Note" to "Hi Note" set on each Performance section.

● Polyphonic Key Pressure

Status	Second	Third
AnH	kkH	vvH

n = MIDI channel : 0H - FH (ch.1 - ch.16)
 kk = Note number : 23H - 5DH (35 - 93)
 vv = Value : 00H - 7FH (0 - 127)

If the "Aftertouch" of the MIDI parameter is set at ON, the TD 7 recognizes the message on the channel of each section.

If the value is greater than or equal to 40H (64), the decay of the instrument which corresponds to the note number is made shorter. This message is not recorded in the Phrase Sequencer.

● Control Change

○ Volume

Status	Second	Third
BnH	07H	vvH

n = MIDI channel : 0H - FH (ch.1 - ch.16)
 vv = Volume : 00H - 7FH (0 - 127)

If the "Volume Rx" of the MIDI parameter is set at ON, the TD 7 receives the message on the channel of each section.

○ Panpot

Status	Second	Third
BnH	0AH	vvH

n = MIDI channel : 0H - 0FH (ch.1 - ch.16)
 vv = Panpot : 00H - 7FH (0 - 127)

If the "Pan Rx" of the MIDI parameter is set at ON, the TD 7 receives the message on the channel of each section.

○ Expression

Status	Second	Third
BnH	0BH	vvH

n = MIDI channel : 0H - 0FH (ch.1 - ch.16)
 vv = Expression : 00H - 7FH (0 - 127)

If the "Volume Rx" of the MIDI parameter is set at ON, the TD 7 receives the message on the channel of each section.

○ Modulation Depth

Status	Second	Third
BnH	01H	vvH

○ Foot Type

Status	Second	Third
BnH	04H	vvH

○ General Purpose Controller - 1

Status	Second	Third
BnH	10H	vvH

○ General Purpose Controller - 2

Status	Second	Third
BnH	11H	vvH

n = MIDI channel : 0H - 0FH (ch.1 - ch.16)
 vv = Parameter value : 00H - 7FH (0 - 127)

Only the controller set on "Ctrl Chg" of MIDI parameter receives the message on the channel of each section and is recorded in the Phrase Sequencer.

The result of receiving the message depends on the parameter of "CtrlMode" of each section.

The value is recorded in the Phrase Sequencer as the position of the Hi-Hat Control pedal.

○ Hold1

Status	Second	Third
BnH	40H	vvH

n = MIDI channel : 0H - 0FH (ch.1 - ch.16)
 vv = Parameter value : 00H - 7FH (0 - 127)

If the "Hold Rx" of the MIDI parameter is set at ON, the TD 7 receives the message on the channel of each section.

If the "Ctrl Chg" of MIDI parameter is set at HOLD, the result of receiving the message depends on the parameter of "CtrlMode" of each section. If the "Ctrl Chg" of MIDI parameter of each section is set at HOLD, this message is recorded in the Phrase Sequencer as position of the Hi-Hat Control Pedal.

● Pitch Bend Change

Status	Second	Third
EnH	0H	mmH

n = MIDI channel : 0H - FH (ch.1 - ch.16)
 mm, ll = Pitch bend value : 00H, 00H - 40H, 00H - 7FH, 7FH (- 8192 - 0 - + 8191)

If the "Pitch Bend" of the MIDI parameter is set at OFF, the TD 7 does not receive the message. This message is not recorded in the Phrase Sequencer.

■ Channel Mode Message

● Reset All Controllers

Status	Second	Third
BnH	79H	00H

n = MIDI channel : 0H - FH (ch.1 - ch.16)

The TD 7 receives the message on the channel of each section.

The TD 7 initializes all the controllers upon receiving this message.

Pitch Bend Change	± 0 (Center)
Panpot	OFF
Volume	127
Expression	127
Hold1	0
The controller set on "Ctrl Chg"	0

This message is not recorded in the Phrase Sequencer.

2.2 Receive Messages to Control the System

■ Channel Voice message

● Program Change

Status	Second
CnH	ppH

If the "Prgr Chg Rx" of the MIDI parameter is set at ON, the TD-7 receives on the channel set by "Ctrl Ch" of the MIDI parameter. This message is not recorded in the Phrase Sequencer.

■ System Real Time Messages

● Timing Clock

Status
F8H

Recognize only sync mode when set at MIDI.

● Active Sensing

Status
FEH

Whenever the TD-7 receives this message, it monitors the interval of the incoming data. If the subsequent message has not arrived within 300ms after the previous data, it processes all sections as though it has received a Reset All Controllers, and mutes the sounding voices, then stops monitoring receiving interval.

■ System Exclusive Message

Status
FOH : System Exclusive
F7H : EOX (End of Exclusive)

With the TD-7, the System Exclusive Message can be used to transmit and receive parameters of sequence and setup data.

For details refer to "Roland Exclusive Messages" and paragraph "3. Exclusive Communications."

Ignore System Exclusive message if parameter Sys Exc Rx = OFF of MIDI Parameter. System Exclusive messages are not recorded in the Phrase Sequencer.

3. Exclusive Communications

■ General

TD-7 can do one-way communications to send and receive parameters for sequence and setup.

Model ID included in the exclusive message should be 58H. The device ID code should be MIDI parameter Device ID of System. Note that the actual value that set in the device ID field is smaller by one than the value set at parameter Device ID of System.

■ One Way Communications

Request data RQ1 11H

Byte	Description
FOH	Exclusive status
41H	Manufacturer ID (Roland)
DEV	Device ID (00H - 1FH)
58H	Model ID (TD-7)
11H	Command ID (RQ1)
aaH	Address MSB
aaH	Address
aaH	Address
aaH	Address LSB
ssH	size MSB
ssH	size
ssH	size
ssH	size LSB
sum	Check sum
F7H	EOX (End of Exclusive)

Data set DT1 12H

Byte	Description
FOH	Exclusive status
41H	Manufacturer ID (Roland)
DEV	Device ID (00H - 1FH)
58H	Model ID (TD-7)
12H	Command ID (DT1)
aaH	Address MSB
aaH	Address
aaH	Address
aaH	Address LSB
ddH	data
.	.
sum	Check sum
F7H	EOX (End of Exclusive)

■ Transmission

The TD-7 transmits Exclusive messages only when MIDI Bulk dump is performed by panel operation in the menu of System functions.

■ Receive

TD-7 is stopped and Bulk dump is not performed.

4. Parameter address map

Addresses are shown in every 7-bit hexadecimal.

Address	MSB			LSB
Binary	0aaa aaaa	0bbb bbbb	0ccc cccc	0ddd dddd
7-bit hex.	AA	BB	CC	DD

■ Parameter base addresses

Start Address	Description
00 00 00 00	Patch parameters #4-1
:	:
01 00 00 00	instrument parameters #4-2
:	:
02 00 00 00	global performance parameters #4-3
:	:
03 00 00 00	system set up #4-4
:	:
04 00 00 00	chain setup #4-5
:	:
05 00 00 00	sequence data #4-6

Table 4-1 Patch parameters

pp : Patch No.(0 - 31)
 nn : Note No.(35 - 93)
 tt : TRIG No.(1 : T1 2 : R1 - 17; T9 18 : R9)

Offset Address	Description
pp 00 00	PROGRAM CHANGE No. 0 - 127
00 01	PROGRAM CHANGE No. 0 - 1(1:0FF)
00 02	Name ASCII(left) 32 - 127
00 03	Name ASCII 32 - 127
00 04	Name ASCII 32 - 127
00 05	Name ASCII 32 - 127
00 06	Name ASCII 32 - 127
00 07	Name ASCII(right) 32 - 127
00 08	PFM1 SOUND (1-512) Upper 2bits 0 - 3
00 09	PFM1 SOUND (1-512) Lower 7bits 0 - 127
00 0A	PFM2 SOUND (1-512) Upper 2bits 0 - 3
00 0B	PFM2 SOUND (1-512) Lower 7bits 0 - 127
00 0C	PFM3 SOUND (1-512) Upper 2bits 0 - 3
00 0D	PFM3 SOUND (1-512) Lower 7bits 0 - 127

00 0E	Effect1 TYPE	0 - 3
		(0:BALL 1:ROOM 2:PLATE 3:DELAY)
00 0F	Hall Out Level	0 - 15
00 10	Hall Rv Time	0 - 15
00 11	Hall Pre LPF	0 - 15
00 12	Room Out Level	0 - 15
00 13	Room Rv Time	0 - 15
00 14	Room Pre LPF	0 - 15
00 15	Plate Out Level	0 - 15
00 16	Plate Rv Time	0 - 15
00 17	Plate Pre LPF	0 - 15
00 18	Delay Out Level	0 - 15
00 19	DelayLeft Time(1-225)Upper4bits	0 - 15
00 1A	DelayLeft Time(1-225)Lower4bits	0 - 15
00 1B	DelayRightTime(1-225)Upper4bits	0 - 15
00 1C	DelayRightTime(1-225)Lower4bits	0 - 15
00 1D	Delay Pre LPF	0 - 15
00 1E	Delay Feedback	0 - 15

00 1F	Effect2 TYPE	0 - 1
		(0:CHORUS 1:FLANGER)
00 20	Chorus Out Level	0 - 15
00 21	Chorus Rate	0 - 31
00 22	Chorus Depth	0 - 15
00 23	Flange Out Level	0 - 15
00 24	Flange Rate	0 - 31
00 25	Flange Feedback	0 - 15
00 26	Flange Depth	0 - 15
00 27	Flange DelayTime	0 - 31

00 28	PDL CtrlMode	0 - 11
		(0:OFF 1:Decay-W 2:Decay-N 3:Decay+N 4:Decay+W 5:Pitch-W 6:Pitch-N 7:Pitch+N 8:Pitch+W 9:Nuance 10:HiHat1 11:HiHat2)

00 29	PDL Assign	0 - 9
		(0:ALL 1-9:TRIG No.)
00 2A	PDL PdCurve	0 - 3
00 2B	PDL Note #	35 - 93
		(127:OFF)
00 2C	PDL Gate Time	1 - 40
00 2D	PDL VelCurve	0 - 7
		(0-3:Norm1-4 4-7:Fix32-127)

00 2E	PDL SeqPtn #	0 - 48
		(0:OFF 1-48:Ptn #)
tt 00	TRIG Note #	35 - 93
tt 01	TRIG Gate Time	1 - 40
tt 02	TRIG CrsTrkGrp	0 - 4
		(0:OFF 1-4:Group No)
tt 03	TRIG VelCurve	0 - 7
		(0-3:Norm1-4 4 7:Fix32-127)
tt 04	TRIG Max Dyna	0 - 15
tt 05	TRIG Min Dyna	0 - 15
tt 06	TRIG Min Velo	0 - 15
tt 07	TRIG Mask Time	0 - 31
tt 08	TRIG Threshold	0 - 15
tt 09	TRIG Choke	0 - 1
		(0:OFF 1:ON)
tt 0A	TRIG SeqPtn #	0 - 48
		(0:OFF 1-48:Ptn #)

nn 00	Layer TYPE	0 - 5
		(0:OFF 1:Velo Mix 2:Velo Sw1 3:Velo Sw2 4:Velo Cross1 5:Velo Cross2)

nn 01	Layer VALUE (1-8)	0 - 7
nn 02	Sound1 Pitch (-48 - 0 - +48)	2's complement lower 7bits
		50H - 00H - 30H
nn 03	Sound1 Inst (1-512)	Upper 2bits
		0 - 3
nn 04	Sound1 Inst (1-512)	Lower 7bits
		0 - 127
nn 05	Sound2 Pitch (-48 - 0 - +48)	2's complement lower 7bits
		50H - 00H - 30H
nn 06	Sound2 Inst (1-512)	Upper 2bits
		0 - 3
nn 07	Sound2 Inst (1-512)	Lower 7bits
		0 - 127

Table 4 - 2 Instrument parameters
01 11 : Inst No.(0 - 511)

Offset	Address	Description
01 11 00	Name ASCII(left)	32 - 127
01	Name ASCII	32 - 127
02	Name ASCII	32 - 127
03	Name ASCII	32 - 127
04	Name ASCII	32 - 127
05	Name ASCII(right)	65 - 90(Capital letter only)
06	Waveform No. (1-256)	Upper 4bits
		0 - 15
07	Waveform No. (1-256)	Lower 4bits
		0 - 15
08	Polyphony	0 - 1
		(0:Poly 1:Mono)
09	AssignGroup	0 - 31
		(0:OFF 1-31:Group No.)

0A	Pitch (-480 - 0 - +480)	2's complement Upper 3bits
		04H - 00H - 03H
0B	Pitch (-480 - 0 - +480)	2's complement Lower 7bits
		00H - 7FH
0C	Decay (-31 - 0 - +31)	Not 2's complement
		00H 1FH - 3EH
0D	Pan	0 - 15
		(1.7 - R7,RND)
0E	Nuance (-7 - 0 - +7)	Not 2's complement
		00H - 07H - 0EH
0F	Brilliance	0 - 15
10	AttackDamp	0 - 15
11	Bend Time	0 - 31
12	DynaPtBend (-7 - 0 - +7)	2's complement Lower 4bits
		09H - 00H - 07H
13	Send2Level	0 - 15
14	Send1Level	0 - 15
15	Out Level	0 - 15

Table 4 - 3 Global performance parameters
0g : Performance No.(0 - 2)

Offset	Address	Description
0g 00	Low Note	35 - 93
01	Hi Note	35 - 93
02	CtrlMode	0 - 9
		(0:OFF 1:Decay-W 2:Decay-N 3:Decay+N 4:Decay+W 5:Pitch-W 6:Pitch-N 7:Pitch+N 8:Pitch+W 9:Nuance)
03	Level	0 - 15
04	KfwNote	35 - 93
05	KfwPitch (-99 - 0 - +99)	2's complement Upper 1bit
		01H - 00H(01H:- 00H:*)
06	KfwPitch (-99 - 0 - +99)	2's complement Lower 7bits
		1DH 00H - 53H
07	KfwDecay (-7 - 0 - +7)	2's complement Lower 4bits
		09H - 00H - 07H
08	KfwNuanc	0 - 10
		(0:-2 1:-1 2:-1/2 3:-1/4 4:-1/8 5:0 6:+1/8 7:+1/4 8:+1/2 9:+1 10:+2)
09	Kfw Pan	0 - 10
		(0:-2 1:-1 2:-1/2 3:-1/4 4:-1/8 5:0 6:+1/8 7:+1/4 8:+1/2 9:+1 10:+2)

Table 4 - 4 System parameters

Offset	Address	Description
00	Trig Tx Ch	0 - 15
01	Inst Tr Ch	0 - 15
02	PFM1 Tr Ch	0 - 15,127(127:OFF)
03	PFM2 Tr Ch	0 - 15,127(127:OFF)
04	PFM3 Tr Ch	0 - 15,127(127:OFF)
05	Ctrl Tr Ch	0 - 15
06	Ctrl Chg	0 - 4
		(0:FOOT 1:MODU 2:ROLD 3:GNL1 4:GNL2)
07	Inst Level	0 - 15
08	Pitch Bend	0 - 12(0:OFF)
09	Foot Sw	0 - 2(0:Model 1:Mode2 2:S on S)
0A	SET SEND1	0 - 2(0:OFF 1:EFFECT1 2:IND1)
0B	SET SEND2	0 - 2(0:OFF 1:EFFECT2 2:IND2)
0C	Prg Chg Rx	0 - 1(0:OFF 1:ON)
0D	Prg Chg Tx	0 - 1(0:OFF 1:ON)
0E	NoteOff Rx	0 - 1(0:OFF 1:ON)
0F	Midi Mix	0 - 1(0:OFF 1:ON)
10	Midi Out	0 - 1(0:OFF 1:ON)
11	INTERFACE MODE	0 - 2
		(0:STANDARD 1:MIDI-SOUND 2:TRIG-MIDI)
12	Volume Rx	0 - 1(0:OFF 1:ON)
13	Pan Rx	0 - 1(0:OFF 1:ON)
14	Hold Rx	0 - 1(0:OFF 1:ON)
15	Local Ctrl	0 - 1(0:OFF 1:ON)
16	Aftertouch	0 - 1(0:OFF 1:ON)

Table 4-5 Chain parameters
 Oc: chain No.(0-7)
 ss: step No.(1-16)

Offset Address	Description
0c 00 CHAIN STEP	0 - 15(step1-16)
ss PATCH No.	0 - 31(1-32)

Table 4-6 Phrase sequencer parameters

Data included in the area are: Phrase sequencer parameters and User patterns 1 to 24.
 If you want to send Data Request to the TID 7 in this area, set the address and the size as follows.

address: 05 00 00 00
 size : 00 01 00 00

Address	Block	Sub block	Reference		
00 00 00 00	Patch Param.	Patch#0	4-1		
		Patch#1			
		:			
		:			
		Patch#30			
		:			
		Patch#31			
		01 00 00 00	Inst Param.	Inst #0	4-2
				Inst #1	
				:	
				:	
				Inst #510	
				Inst #511	
02 00 00 00	GPFM Param.	GPFM1	4-3		
		GPFM2			
		GPFM3			
03 00 00 00	System setup		4-4		
04 00 00 00	Chain setup	Chain #1	4-5		
		Chain #2			
		:			
		Chain #15			
		Chain #16			
05 00 00 00	Seq data	Internal	4-6		

5. Useful Information

● Decimal and Hexadecimal

It is common to use 7-bit Hexadecimal numbers in MIDI communication. The following is a conversion table between decimal numbers and 7-bit Hexadecimal numbers.

Decimal	Hexa- decimal	Decimal	Hexa- decimal	Decimal	Hexa- decimal	Decimal	Hexa- decimal
0	00H	32	20H	64	40H	96	60H
1	01H	33	21H	65	41H	97	61H
2	02H	34	22H	66	42H	98	62H
3	03H	35	23H	67	43H	99	63H
4	04H	36	24H	68	44H	100	64H
5	05H	37	25H	69	45H	101	65H
6	06H	38	26H	70	46H	102	66H
7	07H	39	27H	71	47H	103	67H
8	08H	40	28H	72	48H	104	68H
9	09H	41	29H	73	49H	105	69H
10	0AH	42	2AH	74	4AH	106	6AH
11	0BH	43	2BH	75	4BH	107	6BH
12	0CH	44	2CH	76	4CH	108	6CH
13	0DH	45	2DH	77	4DH	109	6DH
14	0EH	46	2EH	78	4EH	110	6EH
15	0FH	47	2FH	79	4FH	111	6FH
16	10H	48	30H	80	50H	112	70H
17	11H	49	31H	81	51H	113	71H
18	12H	50	32H	82	52H	114	72H
19	13H	51	33H	83	53H	115	73H
20	14H	52	34H	84	54H	116	74H
21	15H	53	35H	85	55H	117	75H
22	16H	54	36H	86	56H	118	76H
23	17H	55	37H	87	57H	119	77H
24	18H	56	38H	88	58H	120	78H
25	19H	57	39H	89	59H	121	79H
26	1AH	58	3AH	90	5AH	122	7AH
27	1BH	59	3BH	91	5BH	123	7BH
28	1CH	60	3CH	92	5CH	124	7CH
29	1DH	61	3DH	93	5DH	125	7DH
30	1EH	62	3EH	94	5EH	126	7EH
31	1FH	63	3FH	95	5FH	127	7FH

- *To indicate a decimal number for the MIDI channel and Program number, add 1 to the Decimal number in the table.
- *The resolution of 7-bit Hexadecimal numbers is 128. Use several bytes for values which require more resolution. i.e. The number "aa bbH" in 7-bit Hexadecimal is "aa x 128 + bb" in Decimal form.
- *A signed number is indicated as 00H = -64, 40H = ± 0, 7FH = -63. So the signed number "aaH" in 7-bit Hexadecimal is "aa - 64". A signed number using two bytes is indicated as 00 00H = -8192, 40 00H = ± 0, 7F 7FH = + 8191. So the signed number "aa bbH" in 7-bit Hexadecimal is "aa bbH - 40 00H = aa x 128 + bb - 64 x 128"
- *The data indicated as "nibbled" is a 4-bit Hexadecimal number. i.e. "0a 0bH" is "a x 16 + b".

< EXAMPLE 1 > Convert "5AH" in Hexadecimal to a Decimal number.
 (By using the table) 5AH = 90

< EXAMPLE 2 > Convert "12 34H" in 7-bit Hexadecimal to a Decimal number.
 (By using the table) 12H = 18, 34H = 52
 So, 18 x 128 + 52 = 2356

< EXAMPLE 3 > Convert "0A 03 09 0D" in nibbled form to a Decimal number.
 (By using the table) 0AH = 10, 03H = 3, 09H = 9, 0DH = 13
 So, ((10 x 16 + 3) x 16 + 9) x 16 + 13 = 41885

● Example of actual MIDI messages

< EXAMPLE 1 > C9 49

"Cn" is a status of a Program change message, and "n" is a MIDI channel number.
 The second byte is a Program number.
 $9H = 9, 49H = 73$
 So, this is a Program change message of MIDI channel = 10,
 Program number = 74.

● Example and Checksum of Roland System Exclusive messages

Roland System Exclusive messages (RQ1 and DT1) have a Checksum at the end of the data (before EOF) to check for communication errors. The Checksum results from address and data (or size) included in the message.

○ How to calculate Checksums ("H" indicates Hexadecimal.)

The error checking process uses a Checksum and provides a bit pattern where the last significant 7 bits are zero when values for an address, data (or size) and the Checksum are summed.

If the address is "aa bb ccd" and the data (or the size) is "dd ee fff"

$$\begin{aligned} aa + bb + cc + dd + ee + ff &= \text{sum} \\ \text{sum} : 128 &= \text{quotient} \dots \text{remainder} \\ 128 - \text{remainder} &= \text{checksum} \end{aligned}$$

< EXAMPLE 1 > Set Decay of the Instrument 1 to 0.

See the "Parameter address map"

Address : 01 00 00 0CH (01 00 00 00H + 00 00 0CH)
 the value of Decay : 0 is 1FH

F0 41 10 58 12 01 00 00 0C 1F ?? F7

 (1) (2) (3) (4) (5) address data checksum (6)

- (1) Exclusive Status (4) Model ID (TD 7)
- (2) ID (Roland) (5) Command ID (DT1)
- (3) Device ID (17) (6) End of Exclusive

The Checksum is :
 $01H + 00H + 00H + 0CH + 1FH = 1 + 0 + 0 + 12 + 31 = 44$ (sum)
 44 (sum) : $128 = 0$ (quotient) ... 44 (remainder)
 checksum = $128 - 44$ (remainder) = $84 = 54H$

Therefore, the message to send is : F0 41 10 58 12 01 00 00 0C 1F 54 F7.

< EXAMPLE 2 > Request to transfer the Instrument number of Sound1, NOTE NUMBER 40, Patch 2.

NOTE NUMBER 40 is 28H in hexadecimal.

See the "Parameter address map"

Address : 00 01 28 03H (00 00 00 00H + 01 28 03H)
 Size : 00 00 00 02H

F0 41 10 58 11 00 01 28 03 00 00 02 ?? F7

 (1) (2) (3) (4) (5) address size checksum (6)

- (1) Exclusive Status (4) Model ID (TD 7)
- (2) ID (Roland) (5) Command ID (DT1)
- (3) Device ID (17) (6) End of Exclusive

The Checksum is :
 $00H + 01H + 28H + 03H + 00H + 00H + 00H + 02H$
 $= 0 + 1 + 40 + 3 + 0 + 0 + 0 + 2 = 46$ (sum)
 46 (sum) : $128 = 0$ (quotient) ... 46 (remainder)
 checksum = $128 - 46$ (remainder) = $82 = 52H$

Therefore, the message to send is : F0 41 10 58 11 00 01 28 03 00 00 02 52 F7.

MIDI Implementation Chart

Function ...		Transmitted	Recognized	Remarks
Basic Channel	Default Changed	1 - 16 1 - 16	1 - 16 1 - 16	Stored (Non-volatile)
Mode	Default Messages Altered	Mode 3 × *****	Mode 3 ×	
Note Number	True Voice	○ *1 35 - 93 *****	×	
Velocity	Note ON Note OFF	○ *1 9n v = 1 - 127 ×	× ×	
After Touch	Key's Ch's	○ *1 0, 127 ×	× ×	
Pitch Bend		×	×	
Control Change	1	× *2	×	Modulation Foot Controllers 1 - 2 Hold 1
	4	○ *2	×	
	16 - 17	× *2	×	
	64	× *2 *1	×	
Prog Change	True #	○ *1 0 - 127	×	Program Number 1 - 128
System Exclusive		×	×	
System Common	Song Pos Song Sel Tune	× × ×	× × ×	
System Real Time	Clock Commands	× ×	× ×	
Aux Messages	Local ON/OFF All Notes OFF Active Sense Reset	× × × ×	× × × ×	
Notes		*1 Can be set to ○ or ×. *2 Can select one of these controllers for the Hi-hat Control Pedal.		

Mode 1 : OMNI ON, POLY
Mode 3 : OMNI OFF, POLY

Mode 2 : OMNI ON, MONO
Mode 4 : OMNI OFF, MONO

○ : Yes
× : No

MIDI Implementation Chart

Function ...		Transmitted	Recognized	Remarks
Basic Channel	Default Changed	OFF, 1 - 16 * 5 OFF, 1 - 16 * 5	OFF, 1 - 16 * 5 OFF, 1 - 16 * 5	Stored (Non-volatile)
Mode	Default Messages Altered	Mode 3 × *****	Mode 3 ×	
Note Number	True Voice	○ * 1 35 - 93 *****	○ * 1 35 - 93	
Velocity	Note ON Note OFF	○ * 1 9n v = 1 - 127 ×	○ * 1 v = 1 - 127 ×	
After Touch	Key's Ch's	× ×	○ * 1 0 - 127 ×	
Pitch Bend		×	× * 1	resolution : 8bit
Control Change	1	× * 2	× * 2	Modulation Foot Volume Panpot Expression Controllers 1 - 2 Hold 1
	4	○ * 2	○ * 2	
	7	×	× * 1	
	10	×	× * 1	
	11	×	× * 1	
	16 - 17	× * 2	× * 2	
	64	× * 2	× * 2 * 1	
	121	×	○	Reset All Controllers
Prog Change	True #	○ * 1 0 - 127	○ * 1 0 - 127	Program Number 1 - 128
System Exclusive		○	○ * 1	
System Common	Song Pos Song Sel Tune	× × ×	× × ×	
System Real Time	Clock Commands	○ * 3 ×	○ * 4 ×	
Aux Messages	Local ON/OFF All Notes OFF Active Sense Reset	× × ○ ×	× × ○ ×	
Notes	* 1 Can be set to ○ or ×. * 2 Can select one of these controllers for the Hi-hat Control Pedal. * 3 Sync mode is INTERNAL. * 4 Sync mode is MIDI. * 5 Can only set the channel of Performance section to OFF.			

Mode 1 : OMNI ON, POLY
Mode 3 : OMNI OFF, POLY

Mode 2 : OMNI ON, MONO
Mode 4 : OMNI OFF, MONO

○ : Yes
× : No

■ How to read a MIDI Implementation Chart

○ : MIDI messages that can be transmitted or received.

× : MIDI messages that cannot be transmitted or received.

● Basic Channel

The MIDI channel for transmitting (or receiving) MIDI messages can be specified over this range. The MIDI channel setting is retained even when the power is turned off.

● Mode

Most recent keyboards use mode 3 (omni off ; poly).

Reception : MIDI messages are received only on the specified channels, and played polyphonically.

Transmission : All MIDI messages are transmitted on the specified MIDI channel.

* "Mode" refers to MIDI Mode messages.

● Note Number

This is the range of note numbers that can be transmitted (or received). Note number 60 is middle C (C4).

● Velocity

This is the range over which velocity can be transmitted (or received) by Note On and Note Off messages.

● Aftertouch

Key's : Polyphonic Aftertouch

Ch's : Channel Aftertouch

● Pitch Bend

The bend range setting of System Parameters determines the range of pitch change caused by Pitch Bend messages.

When set to OFF, Pitch Bend messages will be ignored.

● Control Change

This indicates the control numbers that can be transmitted (or received), and what they will control. For details, refer to the MIDI Implementation.

● Program Change

The program numbers in the chart indicate the actual data. (This is one less than the Patch program numbers.)

● Exclusive

Exclusive message reception can be turned On/Off.

● Common, Real time

These MIDI messages are used to synchronize sequencers and rhythm machines.

● Aux messages

These messages are mainly used to keep a MIDI system running correctly.

Active sensing transmission can be turned on/off.

Specifications

TD - 7 PERCUSSION SOUND MODULE

●Maximum Polyphony

14 voices

●Instruments

Waveforms :256

Instruments :512

●Patch

32

●Patch Chain

8track (16 steps/1track)

●Effects

Effect1

Reverb

Delay

Effect2

Chorus

Flanger

●Phrase Sequence Pattern

User's Patterns :24

Preset Patterns :24

●Resolution

Phrase Sequencer per quarter note :96

Sound - on - Sound per quarter note :96

●Tempo(bpm)

♩ = 24~260

●Display

16 characters × 2 lines (backlit LCD)

●Indicators

MIDI Message Indicator

System Indicator

Sequencer Indicator

Edit Indicator

Jump Indicator

●Data Input Method

Phrase Sequencer :Realtime

Sound - on - Sound :Realtime

●Connectors

Stereo Output Jacks (L,R)

Individual Output Jacks (1,2)

Headphone Jack

MIDI Connectors (IN,OUT)

Footswitch Jack (Stereo)

Hi - hat Control Jack (Stereo)

Trigger Input Jacks (Stereo) (with Rim Shot) : 9

AUX IN Jack (Stereo)

●Power Supply

AC12V :AC Adaptor

●Current Draw

650mA

●Dimensions

218 (W) × 234 (D) × 44 (H) mm

8 - 5/8 (W) × 9 - 1/4 (D) × 1 - 3/4 (H) inches

●Weight

1.35 kg (without AC Adaptor)

3 lbs

●Accessories

Owner's Manual

AC Adaptor

●Options

Pad (PD - 7)

Kick Trigger Unit (KD - 7)

Hi - hat Control Pedal (FD - 7)

Compact Drum Stand (MDS - 7)

Symbal Holder Set (MDY - 7)

Pad Holder (MDH - 7)

Rack Mount Adaptor(RAD-50)

Footswitch (FS - 5U)

Footswitch Cable (PCS - 31)

Stereo Headphone (RH - 120)

*The specifications for this product are subject to change without prior notice.

INDEX

A

Active Sensing	113
Aftertouch	112
Aftertouch Transmit/Receive Switch	118
All Initialize	133
Assign	68
Assign Group	87
Attack Damp	85
Automatic Parameter Setting	45
Available Memory	105

B

Beat	98
Brilliance	85
Bulk Damp	122

C

Channel Message	111
Choke	45
Choke Effect	22
Contrast	18
Control Change Mode	74
Control Change	112, 121
Control Mode	66
Control Number	112
Cross Talk Cancel Group	44
Cursor	18, 30

D

DP - 2	124
Decay	83
Delay Left Time	63
Delay Right Time	63
Delay Time	64
Delay	59
Demo Song	19
Depth	64
Device ID	116
Drum Part	110
Drum Stand	10
Dynamic Pitch Bend Time	86
Dynamic Pitch Bend	85
Dynamic Range	46

E

Echo	59
Edit	24, 34
Effect Type	59
Effect1	59, 131
Effect2	59, 131
Erase Sequence Data	99
Exclusive Message	113

F

FD - 7	65
FS - 5U	124
Feedback	63, 64
Flanger	59
Flanging Effect	59
Foot switch	124
Foot switch1	124
Foot switch2	124

G

GBN method	70
Gate Time	43, 69

Global Performance Parameter	73
Group Bank Number	70

H

Head	21
Hi - hat Control Pedal Initialize	132
Hi - hat Control Pedal	65
Hitting the head of the pad	37
Hold Receive Switch	117
Hold	125

I

Individual Output	59
Individual Output 1	131
Individual Output 2	131
Initialization	132
Instrument	36
Instrument Copy	89
Instrument Name	82
Instrument Parameter	78
Instrument Section	37, 49, 109
Instrument Section Level	119
Instrument Section Transmit/Receive Channel	115
Interface Mode	123
Interval	128

J

Jump to Instrument	54
Jump to Note	48
Jump to Trigger	55
Jump Function	81

K

Key Follow Decay	75
Key Follow Nuance	75
Key Follow Pan	75
Key Follow Parameter	74
Key Follow Pitch	75
Key Follow Reference Note Number	74

L

LCD	18
Layer	52
Level	74
Liquid Crystal Display	18
Local Control	120
Low Pass Filter	62

M

MC - 50	14
MDS - 7	10
MIDI	107
MIDI Channel	109
MIDI Connector	108
MIDI IN	108
MIDI Implementation	158
MIDI Implementation Chart	113, 164
MIDI Message	108
MIDI OUT	108
MIDI Parameters	114
MIDI THRU	108
Main Screens	34
Manual	64
Mask Time	47
Max Dynamic	46

Maximum Polyphony	110
Memory	37, 105
Menu	34
Metronome	103
Midi In Switch	117
Midi Mix Switch	117
Midi Out Switch	117
Minimum Dynamic	46
Minimum Velocity	46
Multi Timbre	109

N

Normal Part	56, 110
Note Message	111
Note Name	50, 79
Note Number	36, 41, 68
Note Off	43
Note Off Message	117
Note Off Receive Switch	117
Note On	43, 109
Nuance	84
Number of Measures	98, 128

O

Output Level	62, 64, 88, 131
--------------	-----------------

P

PAD - 80	15
PCS - 31	124
PD - 7	16
Pad	16
Performance Section	37, 56, 109
Pan Receive Switch	119
Panning	83
Patch	20, 40
Patch Chain	25
Patch Control Transmit/Receive Channel	116
Patch Copy	71
Patch Play Screen	17, 20
Pattern Creating Screen	96
Pedal	65
Pedal Curve	68
Pedal Parameter	66
Performance Types	100
Phrase Sequencer	95
Pitch	49, 83
Pitch Bend Change	112
Pitch Bend	121
Plate Echo	59
Polyphonic Key Pressure	118
Polyphony(Maximum)	110
Polyphony	86
Power	17
Pre Low Pass Filter	62
Preset Pattern	95
Preview Key	48, 55, 58
Program Change	112
Program Change Message	116
Program Change Number	70
Program Change Receive Switch	118
Program Change Transmit Switch	118

Q

Quantize	97, 128
----------	---------

R

R1—R9	41
RAD - 50	10
Rack Mount Adaptor	10
Rate	64
Realtime	92
Realtime Message	113
Recording	92
Reset All Controller	113
Reverb Time	62
Rhythm Part	110
Rim	20, 21
Rim Shot Signal	37
Rim Shot	20
Roop Recording	92

S

Sampler	123
Section	95
Send1 Level	88, 131
Send2 Level	88, 131
Sequence Pattern	23
Sequence Pattern Number	44, 69
Sequencer	23, 35, 36, 95
Sound Setup	129
Sound on Sound	126
Sound1	49
Sound2	49
Stand Holder	10
Standard Part	56, 110
Step	25
Step End Number	25
Step Number	25
Stereo Jack	16
Synchronized Playback	105
System Exclusive Receive Switch	118, 122
System Message	112
System	107

T

T1—T9	41
Tempo	103
Threshold Level	47
Trigger Input Jack	16
Trigger MIDI Converter	13
Trigger MIDI Interface	123
Trigger Parameter	43
Trigger Signal	37, 41
Trigger Transmit Channel	115

U

User Pattern	95
--------------	----

V

Velocity	111
Velocity Crossfade1	53
Velocity Crossfade2	53
Velocity Mix	52
Velocity Sense Curve	44, 69
Velocity Switch1	52
Velocity Switch2	52
Volume Receive Switch	119

W

Waveform	82
----------	----

Information

When you need repair service, call your local Roland Service Station or the authorized Roland distributor in your country as shown below.

U. S. A.

Roland Corporation US
7200 Dominion Circle
Los Angeles, CA.
90040-3647, U. S. A.
☎ (213)685 - 5141

CANADA

Roland Canada Music Ltd.
(Head Office)
5480 Parkwood
Richmond B. C., V6V 2M4
CANADA
☎ (604)270 - 6626

Roland Canada Music Ltd.
9425 Transcanadienne
Service Rd. N., St Laurent,
Quebec H4S 1V3,
CANADA
☎ (514)335 - 2009

Roland Canada Music Ltd.
346 Watline Avenue,
Mississauga, Ontario L4Z
1X2, CANADA
☎ (416)890 - 6488

AUSTRALIA

Roland Corporation
(Australia) Pty. Ltd.
(Head Office)
38 Campbell Avenue
Dee Why West, NSW 2099
AUSTRALIA
☎ (02)982 - 8266

Roland Corporation
(Australia) Pty. Ltd.
(Melbourne Office)
50 Garden Street
South Yarra, Victoria 3141
AUSTRALIA
☎ (03)241 - 1254

UNITED KINGDOM

Roland(U.K.) Ltd.
Rye Close
Ancells Business Park
Fleet, Hampshire GU13
8UY, UNITED KINGDOM
☎ 0252 - 816181

Roland(U.K.) Ltd.,
Swansea Office
Atlantic Close, Swansea
Enterprise Park, Swansea,
West Glamorgan SA79PJ,
UNITED KINGDOM
☎ (0792)700 - 139

ITALY

Roland Italy S. p. A.
Viale delle Industrie 8
20020 ARESE MILANO
ITALY
☎ 02 - 93581311

SPAIN

Roland Electronics
de España, S. A.
Calle Bolivia 239
08020 Barcelona, SPAIN
☎ 93 - 308 - 1000

GERMANY

Roland Elektronische
Musikinstrumente
Handelsgesellschaft mbH.
Oststrasse 96, 2000
Norderstedt, GERMANY
☎ 040/52 60 090

FRANCE

Musikengro
102 Avenue Jean-Jaures
69007 Lyon Cedex 07
FRANCE
☎ (7)858 - 54 60

Musikengro (Paris Office)
Centre Region Parisienne
41 rue Charles-Fourier,
94400 Vitry s/Seine
FRANCE
☎ (1)4680 86 62

BELGIUM/ HOLLAND/ LUXEMBOURG

Roland Benelux N. V.
Houtstraat 1
B-2260 Oevel-Westerlo
BELGIUM
☎ (0032)14 - 575811

DENMARK

Roland Scandinavia A/S
Langebrogade 6
Box 1937
DK-1023 Copenhagen K.
DENMARK
☎ 31 - 95 31 11

SWEDEN

Roland Scandinavia A/S
DanvikCenter 28 A, 2 tr.
S-131 30 Nacka
SWEDEN
☎ 08 - 702 00 20

NORWAY

Roland Scandinavia
Avd. Norge
Lilleakerveien 2
Postboks 95 Lilleaker
N-0216 Oslo 2
NORWAY
☎ 02 - 73 00 74

FINLAND

Fazer Musik Inc.
Länsituulentie
POB 169
SF-02101 Espoo
FINLAND
☎ 0 - 43 50 11

NEW ZEALAND

Roland Corporation
(NZ) Ltd.
97 Mt. Eden Road, Mt.
Eden, Auckland 3,
NEW ZEALAND
☎ (09)3098 - 715

SWITZERLAND

Musitronic AG
Gerberstrasse 5, CH-4410
Liestal, SWITZERLAND
☎ 061/921 16 15

Roland CK (Switzerland)
AG
Postfach/Hauptstrasse 21
CH-4456 Tenniken
SWITZERLAND
☎ 061/98 60 55
Repair Service by
Musitronic AG

AUSTRIA

E. Dematte & Co.
Neu-Rum Siemens-
Strasse 4
A-6021 Innsbruck Box 591
AUSTRIA
☎ (0512)63 451

GREECE

V. Dimitriadis & Co. Ltd.
2 Phidiou Str., GR 106 78
Athens, GREECE
☎ 1 - 3620130

PORTUGAL

Casa Caius Instrumentos
Musicais Lda.
Rua de Santa Catarina 131
Porto, PORTUGAL
☎ 02 - 38 44 56

HUNGARY

Intermusica Ltd.
Warehouse Area 'DEPO'
Torokbalint, Budapest
HUNGARY
☎ (1)1868905

ISRAEL

D.J.A. International Ltd.
25 Pinsker St., Tel Aviv
ISRAEL
☎ 972 - 3 - 5283015

CYPRUS

Radex Sound Equipment
Ltd.
17 Panteli Katelari Str.
P.O.Box 2046, Nicosia
CYPRUS
☎ 453426, 466423

TURKEY

Barkat Sanayi ve Ticaret
Siraselviler Cad. 86/6
Taksim Istanbul, TURKEY
☎ 149 93 24

EGYPT

Al Fanny Trading Office
9, Ebn Hagar Askalany
Street, Ard El Golf,
Heliopolis, Cairo, EGYPT
☎ 2917803 - 665918

BRAZIL

Roland Brasil Ltda.
R. Alvarenga 591
CEP-05509 Sao Paulo
BRAZIL
☎ (011)813 - 7967
Repair Service for Roland
and Rhodes products

Oliver do Brasil S.A.
Instrumentos Musicais
Av. Ceci. No.578 Centro
Empresarial Tambore
Barueri SP CEP 06400
BRAZIL
☎ (011)709 - 1267
Repair Service for BOSS
products

MEXICO

Case Veerkamp, s.a. de c.v.
Mesones No. 21
Col. Centro
C.P. 06080 Mexico, D.F.
MEXICO
☎ (5)709 - 3716

La Casa Wagner de
Guadalajara s.a. de c.v.
Av. Corona No. 202 S.J.
C.P.44100
Guadalajara, Jalisco
MEXICO
☎ (36)13 - 1414

ARGENTINA

Netto S.A.
Venezuela 1433
1095 Buenos Aires
ARGENTINA
☎ 37 - 1632

HONG KONG

Tom Lee Music Co., Ltd.
Service Division
22-32 Pun Shan Street,
Tsuen Wan, New
Territories, HONG KONG
☎ 415 - 0911

KOREA

Cosmos Corporation
Service Station
261 2nd Floor Nak-Won
arcade
Jong-Ro ku, Seoul, KOREA
☎ (02) 742 8844

SINGAPORE

Swee Lee Company
Bras Basah Complex
#03-23 Singapore 0178
SINGAPORE
☎ 3367886

THAILAND

Theera Music Co., Ltd.
330 Vermg Nakom Kasem,
Soi 2, Bangkok 10100,
THAILAND
☎ 2248821

MALAYSIA

Syarikat Bentley
No.142, Jalan Bukit
Bintang 55100 Kuala
Lumpur, MALAYSIA
☎ 2421288

INDONESIA

PT Galestra Inti
Kompleks Perkantoran
Duta Merlin Blok C/59
Jl. Gajah mada No.3-5
Jakarta 10130
INDONESIA
☎ (021) 354604, 354606

TAIWAN

Siruba Enterprise(Taiwan)
Co., LTD.
Room. 5, 9th. No. 112
Chung Shan N.Road Sec.2
Taipei, TAIWAN, R.O.C.
☎ (02)5364546

SOUTH AFRICA

That Other Music
Shop(PTY) LTD.
256 Bree Street,
Johannesburg 2001
Republic of South Africa
☎ 337 - 6573

Paul Bothner(PTY) LTD.

17 Werdmueller Centre
Claremont 7700
Republic of South Africa
☎ 021 - 64 - 4030

For Nordic Countries

Apparatus containing Lithium batteries

ADVARSEL!

Lithiumbatteri – Eksplosionsfare ved fejlagtig håndtering.
Udskiftning må kun ske med batteri af samme fabrikat og type.
Levér det brugte batteri tilbage til leverandøren.

VARNING!

Explosionsfara vid felaktigt batteribyte.
Använd samma batterityp eller en ekvivalent typ som rekommenderas av apparattillverkaren.
Kassera använt batteri enligt fabrikantens instruktion.

ADVARSEL!

Lithiumbatteri – Eksplosionsfare.
Ved udsifting benyttes kun batteri som anbefalt av apparatfabrikanten.
Brukt batteri returneres apparatleverandøren.

VAROITUS!

Paristo voi räjähtää, jos se on virheellisesti asennettu.
Vaihda paristo ainoastaan laitevalmistajan suosittelemaan tyyppiin. Hävitä käytetty paristo valmistajan ohjeiden mukaisesti.

For Germany

Bescheinigung des Herstellers/Importeurs

Hiermit wird bescheinigt, daß der/die/das

Roland PERCUSSION SOUND MODULE TD-7
.....
(Gerät. Typ. Bezeichnung)

in Übereinstimmung mit den Bestimmungen der

Amtsbl. Vfg 1046/1984
.....
(Amtsblattverfügung)

funk-entstört ist.

Der Deutschen Bundespost wurde das Inverkehrbringen dieses Gerätes angezeigt und die Berechtigung zur Überprüfung der Serie auf Einhaltung der Bestimmungen eingeräumt.

Roland Corporation Osaka/Japan

.....
Name des Herstellers/Importeurs

For the USA

RADIO AND TELEVISION INTERFERENCE

WARNING — This equipment has been verified to comply with the limits for a Class B computing device, pursuant to Subpart J, of Part 15, of FCC rules. Operation with non-certified or non-verified equipment is likely to result in interference to radio and TV reception.

The equipment described in this manual generates and uses radio frequency energy. If it is not installed and used properly, that is, in strict accordance with our instructions, it may cause interference with radio and television reception. This equipment has been tested and found to comply with the limits for a Class B computing device in accordance with the specifications in Subpart J, of Part 15, of FCC Rules. These rules are designed to provide reasonable protection against such a interference in a residential installation. However, there is no guarantee that the interference will not occur in a particular installation. If this equipment does cause interference to radio or television reception, which can be determined by turning the equipment on and off, the user is encouraged to try to correct the interference by the following measure:

- Disconnect other devices and their input/output cables one at a time. If the interference stops, it is caused by either the other device or its I/O cable. These devices usually require Roland designated shielded I/O cables. For Roland devices, you can obtain the proper shielded cable from your dealer. For non Roland devices, contact the manufacturer or dealer for assistance.
- If your equipment does cause interference to radio or television reception, you can try to correct the interference by using one or more of the following measures:
 - Turn the TV or radio antenna until the interference stops.
 - Move the equipment to one side or the other of the TV or radio.
 - Move the equipment farther away from the TV or radio.
 - Plug the equipment into an outlet that is on a different circuit than the TV or radio. (That is, make certain the equipment and the radio or television set are on circuits controlled by different circuit breakers or fuses.)
 - Consider installing a rooftop television antenna with coaxial cable lead-in between the antenna and TV. If necessary, you should consult your dealer or an experienced radio/television technician for additional suggestions. You may find helpful the following booklet prepared by the Federal Communications Commission: "How to Identify and Resolve Radio — TV Interference Problems"

This booklet is available from the U.S. Government Printing Office, Washington, D.C., 20402, Stock No. 004-000-00345-4.

For Canada

CLASS B

NOTICE

This digital apparatus does not exceed the Class B limits for radio noise emissions set out in the Radio Interference Regulations of the Canadian Department of Communications.

CLASSE B

AVIS

Cet appareil numérique ne dépasse pas les limites de la classe B au niveau des émissions de bruits radioélectriques fixés dans le Règlement des signaux parasites par le ministère canadien des Communications.

 Roland®

70906378

UPC 70906378

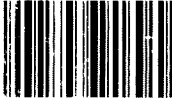

1998:

 Roland